

HUSSMANN®

Parallel Rack Systems



Installation & Operation Manual

IMPORTANT
Keep in store for
future reference!

P/N 0427598_E
August 2018

TABLE OF CONTENTS

INSTALLATION

Shipping Damage 1-1
 General Rack Description 1-1
 General Rack Components 1-1
 Remote Satellite Components 1-2
 Legend, Labels & Wiring Diagrams 1-2
 Setup Sheet 1-2
 Machine Room Requirements 1-3
 Handling 1-4
 Rack Unit Placement 1-5
 Minimum Allowable Distances 1-5
 Maximum Allowable Distances 1-5
 Ventilation 1-6
 Floor Drain 1-6
 Remote Condenser Placement 1-6
 Installing Vibration Pads 1-7
 Rack Sizing Charts 1-8

COMPONENT PIPING & LINE SIZING

Rack Piping Overview 2-1
 Refrigeration Line Runs 2-1
 Insulation 2-3
 Special Piping for Open Rooms 2-3
 Connecting Parallel 3-Way Valves 2-3
 Run Lengths and Equivalent Feet 2-3
 Rack to Condenser Piping 2-4
 Purge Valve Location 2-4
 Receiver Safety Relief Valve 2-4
 Connecting to Two Manifolds 2-5

Equalizing Line 2-5
 Condenser Piping w/ Heat Reclaim 2-6
 Split Condenser Piping 2-7
 Split Condenser Piping (3-Way Valve) 2-8
 Rack to Heat Reclaim 2-9
 Rack to Remote Header 2-9
 Rack to Remote Satellite 2-9
 Discharge Lines for Two Satellites 2-9
 Oil Lines for Remote Satellites 2-9
 Offset and Expansion Loop Const. 2-10
 Branch Line Piping 2-11
 Koolgas Defrost 2-12

REFRIGERATION

Overview 3-1
 Basic Refrigeration Cycle 3-1
 Rack Diagram 3-2
 Thermostatic Expansion Valve 3-3
 Superheat 3-3
 Heat Reclaim Cycle 3-3
 Heat Reclaim Valve 3-4
 Flooding Valve and Receiver Pressure
 Regulating Valve 3-4
 Koolgas Defrost Cycle 3-5
 Oil System 3-5
 Y825 Valve Adjustment 3-6
 Ambient Subcooling 3-7

CONTINUED ON PAGE IV

IMPORTANT
KEEP IN STORE FOR FUTURE REFERENCE
Quality that sets industry standards!

12999 St. Charles Rock Road • Bridgeton, MO 63044-2483

U.S. & Canada 1-800-922-1919 • Mexico 01-800-890-2900

www.hussmann.com

© 2018 Hussmann Corporation

Mechanical Subcooling	3-7
Two Stage Mechanical Subcooling	3-7
Liquid Injection	3-8
EPR Valve	3-9
CPR Valve	3-10
Main Liquid Line Solenoid Valves	3-11
Branch Liquid Line Solenoid Valves	3-11
3-Way Split Condensing Valves.	3-12
Surge Receiver Valves	3-12
Subcooling with Plate Heat Exchanger	3-12
Liquid Line Differential Valve Adjustment.	3-13
SORIT Evap Pressure Reg Adjustment.	3-13
Low Pressure Controls.	3-13
Control Settings General Description	3-15

ELECTRICAL

Electrical Overview.	4-1
Field Wiring	4-1
For Remote Header Defrost Assembly	4-1
For 208-230/3/60 Compressor Units	4-1
Required Field Wire Size	4-1
Merchandiser Electrical Data	4-2
Merchandiser Field Wiring	4-2
Electrical Connections	4-2
Identification of Wiring	4-2
Electrical Diagrams	4-3
Unit Cooler Fan Wiring.	4-3
Cooler Door Switch Wiring	4-3
Component Wiring Guidelines	4-3
Sizing Wire and Overcurrent Protectors	4-3
Other Controls	4-3
Compressor Control.	4-3
Electronic Controller	4-4
Time Delay	4-4
Pressure Switches	4-4
Switchback Control (Optional)	4-4
Crankcase Heaters (Optional)	4-4
Oil Failure Relay	4-4
Current Relay (Optional).	4-4
Defrost Controls.	4-5
Refrigeration Mode	4-5
Defrost Mode	4-5

Temperature Controls	4-5
Refrigeration Thermostat (Alternate)	4-5
Case Probe (Alternate)	4-5
Defrost Termination Thermostat	4-5
Master Defrost Valve	4-5
Alarm Control	4-6
Alarm System	4-6
Alarm Control (Electronic).	4-6
Alarm Systems.	4-6
Inverter Control	4-6
Unit Cooler Fan Wiring	4-7
Evaporator Mounted Liquid Line Solenoid	4-7
Cooler Door Switch Wiring	4-7
Sizing Wire and Overcurrent Protectors	4-7

START-UP

Leak Testing.	5-1
Pre-Charge Check List.	5-1
Charging	5-2
Oil Levels	5-2
Evacuation.	5-3
Final Checks	5-3
Thermostat Settings	5-3
Liquid Drier Core Replacement	5-3
Suction Filter Core Replacement	5-3

MAINTENANCE

Compressor Replacement	6-1
Winter Condensing Pressure Controls	6-2
General Maintenance.	6-3
Drier and Filter Cores Replacement	6-4

SERVICE

Trouble Shooting Information	7-1
Trouble Shooting Guides	7-2
Supermarket Equipment	7-4

REVISION HISTORY

Revision E - Updated with California Warning

Revision D - moved Nomenclature, vi, Added, Page 1-4 Lifting Details, Updated Page 1-6, Revised Drawings in Section 2; Removed Line Sizing Charts

Revision C - Added Trouble Shooting Guide

Revision B - Revised Vibration Pad Table, Page 1-6

ORIGINAL ISSUE — February 2013

ANSI Z535.5 DEFINITIONS



• **DANGER** – Indicate[s] a hazardous situation which, if not avoided, will result in death or serious injury.



• **WARNING** – Indicate[s] a hazardous situation which, if not avoided, could result in death or serious injury.



• **CAUTION** – Indicate[s] a hazardous situation which, if not avoided, could result in minor or moderate injury.

• **NOTICE** – *Not related to personal injury* – Indicates[s] situations, which if not avoided, could result in damage to equipment.



This warning does not mean that Hussmann products will cause cancer or reproductive harm, or is in violation of any product-safety standards or requirements. As clarified by the California State government, Proposition 65 can be considered more of a ‘right to know’ law than a pure product safety law. When used as designed, Hussmann believes that our products are not harmful. We provide the Proposition 65 warning to stay in compliance with California State law. It is your responsibility to provide accurate Proposition 65 warning labels to your customers when necessary. For more information on Proposition 65, please visit the California State government website.

Rack Nomenclature

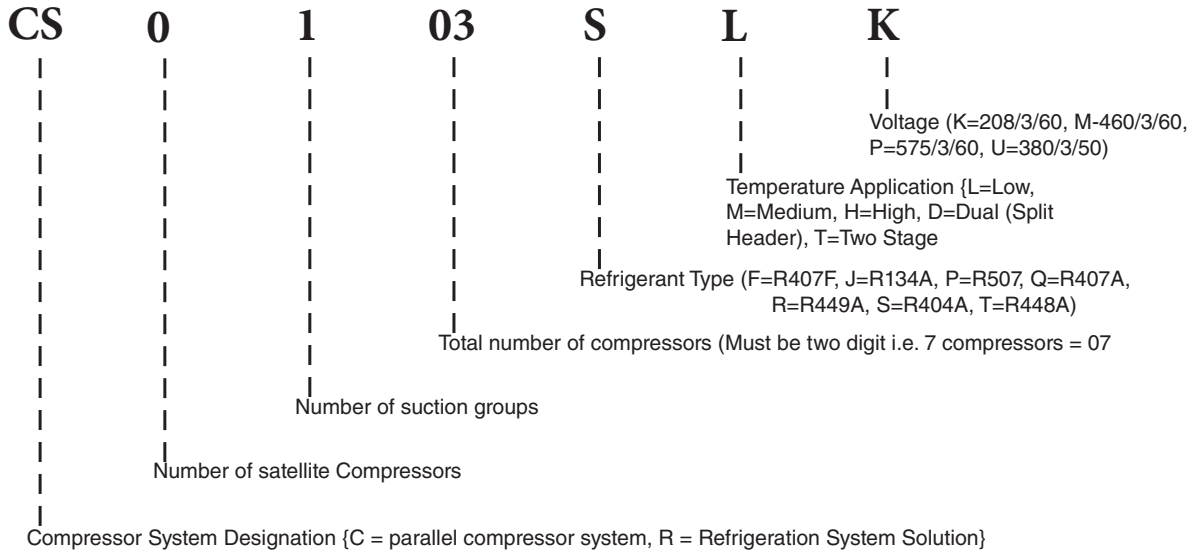

INSTALLATION

SHIPPING DAMAGE

All equipment should be thoroughly examined for shipping damage before and while unloading. This equipment has been carefully inspected at our factory and the carrier has assumed responsibility for safe arrival. If damaged, either apparent or concealed, claim must be made to the carrier. Hussmann parallel compressor systems are cling wrapped and taped prior to shipping via flatbed trailer.

Apparent Loss or Damage

If there is an obvious loss or damage, it must be noted on the freight bill or express receipt and signed by the carrier's agent, otherwise, carrier may refuse claim. The carrier will supply the necessary claim forms.

GENERAL RACK DESCRIPTION

The Hussmann parallel rack operates with up to ten reciprocating or screw compressors or fourteen scroll compressors in parallel design. The compact design reduces space requirements, and its open construction provides convenient access to components for easy maintenance and service.

Typically, all supermarket refrigeration needs are handled by low and medium temperature racks.

An average low temperature rack runs below 0°F and may have a satellite operating as low as -40°F. Common medium temperature racks operate between 0°F and 40°F.

Concealed Loss or Damage

When loss or damage is not apparent until after equipment is uncrated, a claim for concealed damage is made. Upon discovering damage, make request in writing to carrier for inspection within 15 days, and retain all packaging. The carrier will supply an inspection report and required claim forms.

GENERAL RACK COMPONENTS

Each parallel/custom rack contains the following components:

As many as fourteen Copeland Scrolls, or 2-10 Copeland, or 2-10 Carlyle semi-hermetic, or 2-10 Bitzer, or 2-10 Bitzer or Carlye screw compressors with:

- high and low pressure controls
- oil pressure safety control
- primary overload protection
- compressor cooling fans on low temperature application

Factory piping with:

- suction, discharge, liquid header
- defrost header (if applicable)
- oil separator and return system
- receiver
- suction filters on each compressor
- liquid filter drier and sight glass
- liquid level indicator
- liquid level switch

Control Panel: The control panel contains all the necessary energy management components and motor controls factory-wired to the compressors. The interconnected compressors are cycled on and off, via low-pressure settings, by a central controller to match refrigeration capacity with load requirements.

Factory-wired control panel has:

- pre-wired distribution power block
- individual component circuit breakers and contactors
- compressor time delays
- color-coded wiring system

Items supplied separately for field installation:

- liquid dryer cores
- vibration isolation pads
- loose shipped items for accessories
- suction filter cores

REMOTE SATELLITE COMPONENTS

Although the satellite is a separate compressor, its liquid refrigerant is supplied by the rack liquid manifold. The suction gases pulled by the satellite are discharged into the rack discharge manifold. The satellite components include:

One compressor with:

- high and low pressure controls
- oil pressure safety control
- primary overload protection
- compressor cooling fans on low temp

Factory piping with:

- suction and discharge stubs
- oil systems with connections
- suction filter

Factory control panel with:

- pre-wired distribution power block
- individual component circuit breakers
- compressor time delay relays

LEGEND, LABELS & WIRING DIAGRAMS

Each parallel rack is shipped with a detailed legend that identifies the specialized components used such as compressors, valves, oil separators, etc. The legend details line sizing requirements, BTUH loads, control valves, circuit information and suction temperatures.

Type of refrigerant and lubricant to be used are prominently displayed on the front of the rack.

All racks include complete wiring diagrams (control, primary power, board and point layout.) All wiring is color coded.

SETUP SHEET

All set points are to be on a setup sheet mounted inside the door of the rack's electrical cabinet. This sheet includes all set points for field-adjusted components. (i.e. suction pressure, discharge pressure, subcooler setting).

MACHINE ROOM REQUIREMENTS

Equipment must be located in a dedicated operating area to provide enough working space for service personnel and meet electrical codes.

Hussmann recommends ventilation should be a minimum of 65 cfm per compressor unit horse power. The air inlet should be sized for a maximum of 500 fpm velocity. Ventilation fans should cycle by thermostatic control.

Proper ventilation provides needed air flow across the compressors that helps maintain the operation of the rack. Duct work may be necessary. All ventilation equipment is field-supplied and installed. **Check national and local codes for ventilation requirements before installation.**

The equipment room floor must solidly support the compressor unit as a live load. Ground level installation seldom presents problems, but a mezzanine installation must be carefully engineered.

A concrete base must be built on the mezzanine floor to keep mechanical vibrations and noise to an acceptable level.

NOTE

Recommended spacing is site specific. It is the installer's responsibility to check local codes and standards.

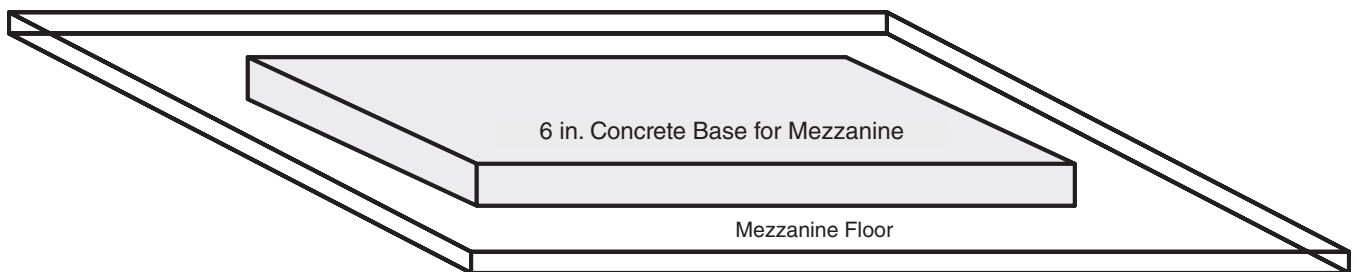

HANDLING

Each compressor rack has lower base frame brackets for rigging and lifting. It is important to use the spreader bar to prevent the rigging from damaging the rack. Before placing the rack in the machine room, remove the shipping skid. For units with vertical receivers, be aware of the level sensor on top of the receiver. Lifting cables and other equipment must not come in contact with any unit piping or electrical components.

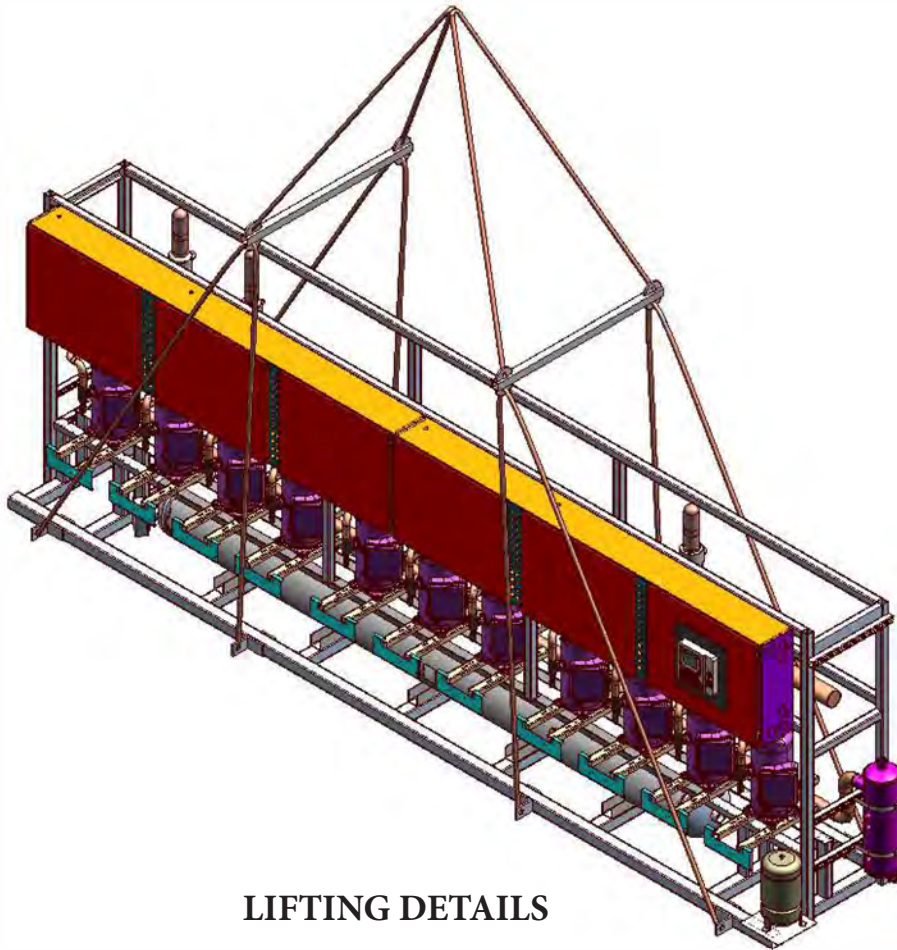

LIFTING DETAILS

RACK UNIT PLACEMENT

Observe the minimum and maximum distances as described below for setting the rack in relation to other refrigeration equipment:

Minimum Allowable Distances

Water-cooled Condenser:

The minimum allowable elevation is one foot from the outlet to the receiver inlet.

Air Cooled Condenser:

The minimum allowable distance is 4 1/2 ft with no flooding valve from the mounting surface of the air-cooled condenser to the mounting surface of the custom rack.

The minimum allowable distance is 6 feet with a flooding valve from the mounting surface of the air-cooled condenser to the center of the flooding valve.

Maximum Allowable Distances

Remote satellites:

should not be placed below the level of the custom or parallel rack. The satellite may be positioned above the rack. The maximum allowable elevation is 6 feet from the bottom of the rack.

Remote Header:

The maximum allowable piping equivalent is 50 feet when piping from the rack to the remote satellite. Piping should be given special consideration when going from the rack to the remote header.

Condenser:

The maximum allowable piping equivalent is 100 feet when piping from the rack to the condenser.

NOTE: Piping equivalent is not the same length as linear distance.

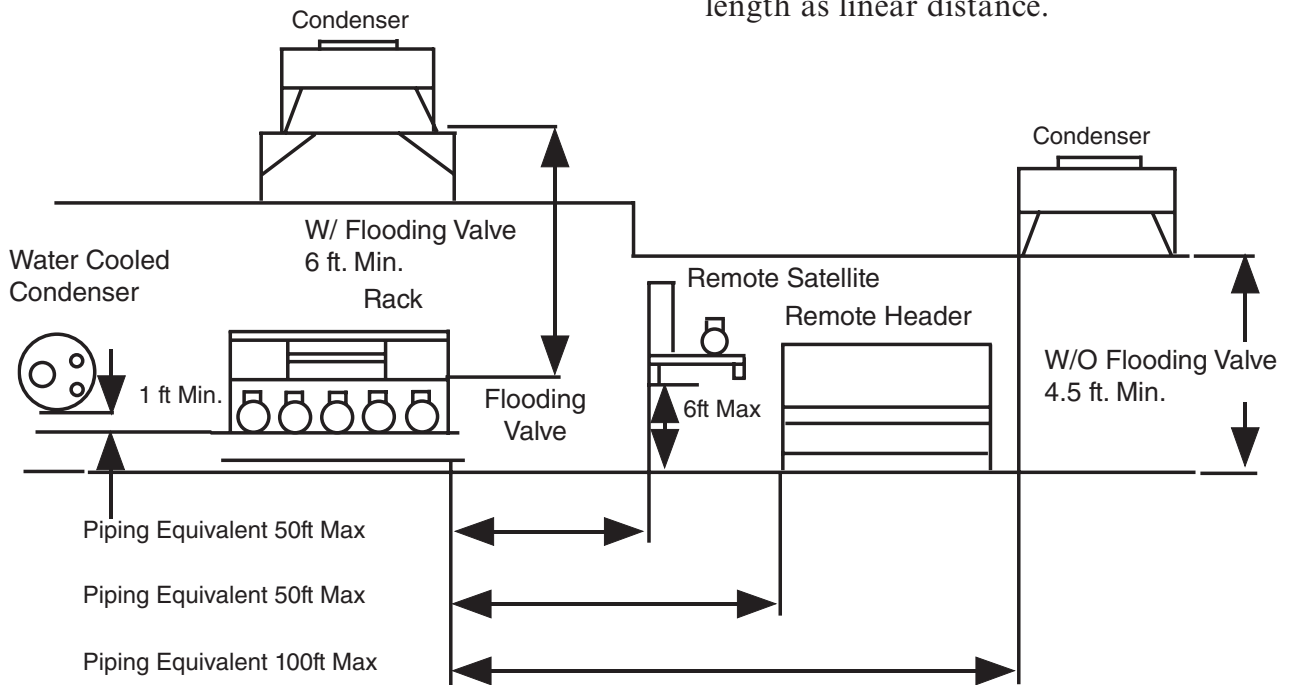

VENTILATION

Cooler climates generally need less ventilation than warmer climates. A warm machine room is going to need a good amount of ventilation. Compressors with head fans can dissipate as much as 20 percent of the heat (or input watts). Air intake should pass over the top of the units where most of the heat remains. See machine room requirements for additional information on ventilation and sizing.

FLOOR DRAIN

Provide a floor drain for disposal of condensate that may form on the compressor unit or header defrost assembly.

REMOTE CONDENSER PLACEMENT

Locate the condenser with at least three feet of clearance on all sides to provide adequate air circulation if not otherwise specified by the condenser manufacturer. If roof mounted, place on column-supported beams or load-bearing walls. The mounting surface for the condenser should be at least six feet higher than the rack flooding valve. When a flooding valve is not used, the minimum distance from the base of the rack to the mounting surface of the condenser is 4.5 ft. If a Krack Microchannel (MX) is used, sufficient room on the right side of the unit must be available to remove the micro channel slabs. At least nine feet of clearance must be available.

Typical Condenser Roof Mount Arrangement

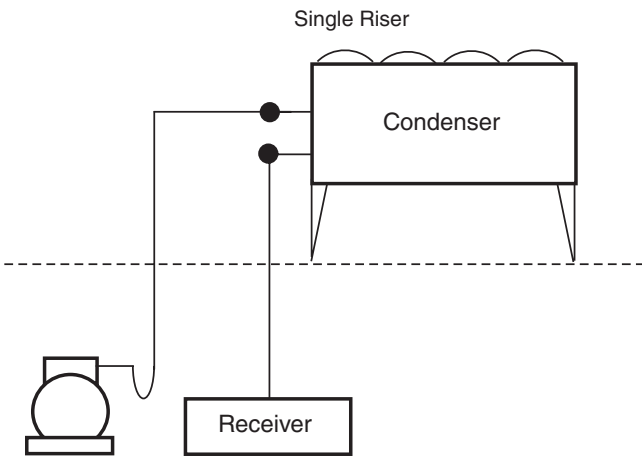

Typical Condenser Roof Mount Arrangement

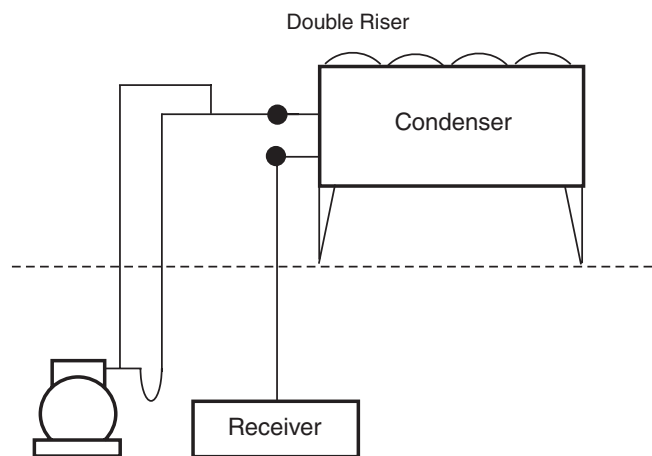

⚠ WARNING
 Be careful when moving or lifting rack. Serious bodily injury or death could occur from falling equipment.

INSTALLING VIBRATION PADS

Each rack must be located in the machine room so that it is accessible from all sides. A minimum of 36 in. clearance is recommended to provide easy access to components. Vibration isolation pads are supplied with each rack. The entire weight of the rack must rest on these pads. The pads should be located as shown in the image below. Cross-level the compressor unit so all compressors are level with each other. To ensure both proper leveling and vibration isolation, perform the following:

1. Lift the rack in accordance with procedures detailed on Pages 1-3.
2. Place minimum 15 gauge 3 in. by 3 in. galvanized or stainless steel shims to compensate for uneven floors. (Shims must be field supplied.)
3. Place vibration isolation pads on top of shims. See vibration pad quantities in the table at right to determine the number of pads to be used.
4. Pads should be placed over structural joist members when rack is placed on sub-floor.

**Vibration Pad Quantities
3 in. x 3 in. x 2 in.**

# of compressors per pack	Reciprocating or Scroll	Screw Compressor
2 Compressors	4 Each	6 Each
3 Compressors	4 Each	6 Each
4 Compressors	6 Each	8 Each
5 Compressors	6 Each	8 Each
6 Compressors	6 Each	8 Each*
7 Compressors	8 Each	-----
8 Compressors	8 Each	-----
9 Compressors	8 Each	-----
10 Compressors	10 Each	-----

***10 for Bitzer and Vertical Receiver**

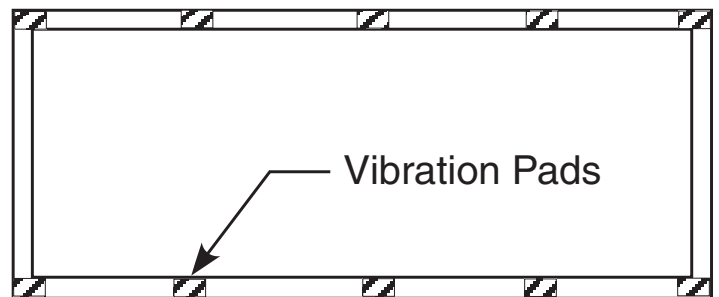

Standard Rack Sizing Chart with Horizontal Receiver

# of Scroll Compressors	# of Reciprocating Compressors	Maximum number of circuits	Length of Rack (in.)	Approximate Operating Weight of Rack
3 or 4	3	11	98	3330
5	4	15	114	4290
6	5	19	138	5230
7	6	21	150	5720
8	7	24	178	6270
9 or 10	8	28	200	6870
11	9	32	222	7470
12	10	36	244	8070

Standard Rack Sizing Chart with Vertical Receiver

# of Scroll Compressors	# of Reciprocating Compressors	Maximum number of circuits	Length of Rack (in.)	Approximate Operating Weight of Rack
3 or 4	3	11	128	3330
5	4	15	144	4290
6	5	19	168	5230
7	6	21	180	5720
8	7	24	208	6270
9 or 10	8	28	230	6870
11	9	32	252	7470
12	10	36	274	8070

Note: Standard rack width is 39 in.
Standard rack height is 78.5 in.

The charts above are acceptable for most compressor models except screw compressors

Dimensions may vary if optional accessories such as inverters, suction accumulators, electric defrost panels, etc. are applied

**Remote Refrigeration Circuit Header
Planning (Floor Mount)**

# of Circuits	Length (inches)	Width (inches)	Height (inches)	Approx. Weight
4	52	36	60	312
6	64	36	60	405
8	76	36	60	489
10	88	36	60	582
12	100	36	60	666
14	112	36	60	750
16	124	36	60	843
18	136	36	60	927
20	148	36	60	1011
22	160	36	60	1104
24	172	36	60	1188

**Remote Refrigeration Circuit
Header Planning (Hanging Mount)**

# of Circuits	Length (inches)	Width (inches)	Height (inches)	Approx. Weight
4	52	34	36	262
6	64	34	36	351
8	76	34	36	431
10	88	34	36	520
12	100	34	36	600
14	112	34	36	680
16	124	34	36	769
18	136	34	36	849
20	148	34	36	929
22	160	34	36	1018
24	172	34	36	1098

COMPONENT PIPING & LINE SIZING

RACK PIPING OVERVIEW

This section provides information for installing the refrigeration lines for a rack. The components are piped as completely as practical at the factory. Field piping requires only interconnection of the major components and the coolers, freezers and display cases. Piping must also be supported to minimize vibration. Pulsation of the refrigerant and compressor vibration can cause piping to vibrate. This vibration can cause line breakage and damage to components.

Use only clean, dehydrated, sealed refrigeration grade copper tubing. Use dry nitrogen at low pressure in the tubing during brazing to prevent the formation of copper oxide. All joints should be made with a 15 percent silver alloy brazing material. Use a 45 percent silver solder for dissimilar metals.



WARNING

Always use a pressure regulator when operating nitrogen tanks.

REFRIGERATION LINE RUNS

Liquid Lines and suction lines must be free to expand and contract independently of each other. Do not clamp or solder them together. Supports must allow tubing to expand and contract freely. Do not exceed 100 feet without a change of direction or/and offset. Plan proper pitching, expansion allowance, and waterseal at the base of all suction risers. Use long radius elbows to reduce line resistance and breakage. Avoid the use of 45 degree elbows. Install service valves at several locations for ease of maintenance and reduction of service costs. These valves must be UL approved for the minimum design working pressure of the system.



Ceiling Run with Supports

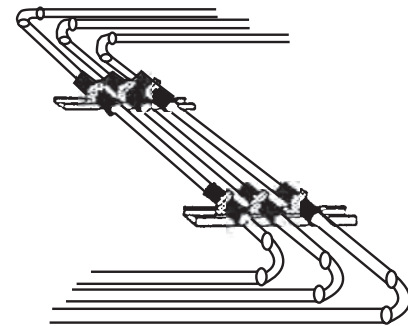

Floor Piping Run

Through Walls or Floors

Refrigeration lines that are run through walls or floors must have a waterseal installed, and the lines must be properly insulated. Avoid running lines through the refrigeration cases. When this is done the lines must be adequately insulated using a closed-cell elastomeric foam insulation.

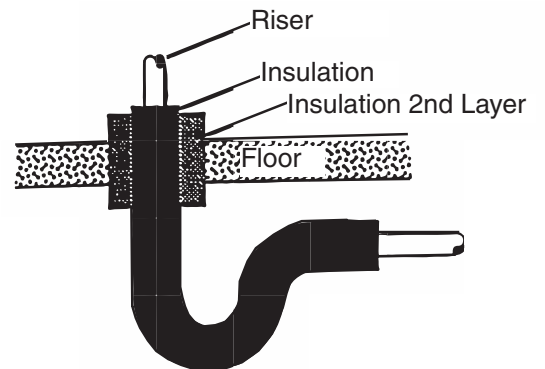

Insulating a Riser

From Machinery to Solid Object

When mounting lines from machinery to a solid object allow line freedom for vibration to prevent metal fatigue.

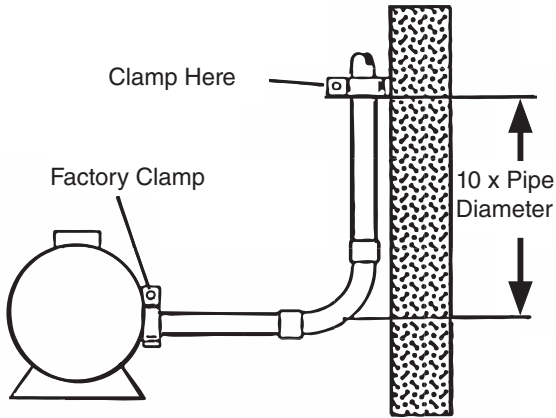

Don't over support piping that is in contact with the compressor racks. The machinery must not be tightly stressed from piping that does not allow for some vibration. If piping is too tight metal fatigue will occur.

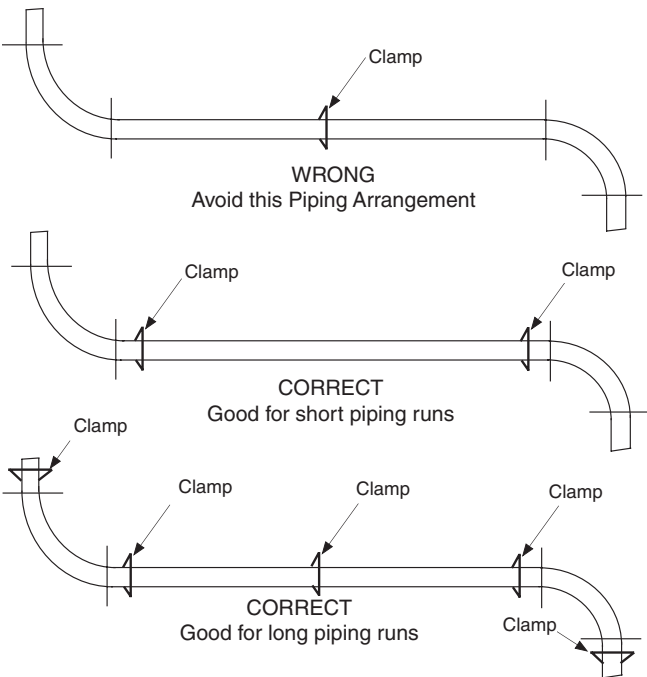

Waterseal Construction

Waterseals must be installed at the bottom of all suction risers to return oil to the compressors to avoid trapping oil.

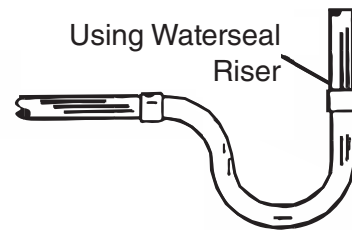
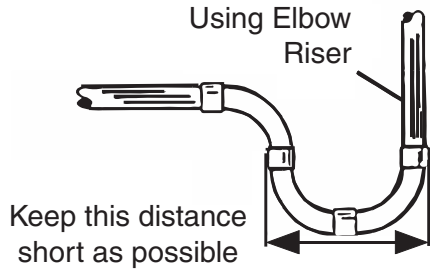

Waterseal Construction

Reduced Riser

When a reduced riser is necessary, place the reduction coupling downstream of the waterseal.

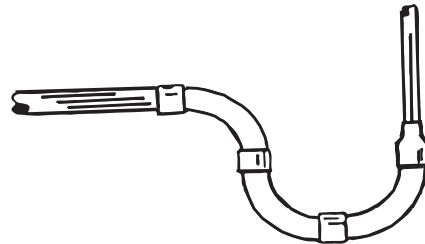

Reduces Riser

Protecting Valves and Clamps

When brazing near factory installed clamps or valves be sure to protect them with a wet rag to avoid overheating. Insulate all reduced risers.

All clamps must be properly anchored. Rubber gromets must be installed to prevent chafing of the lines.

Elbows

Only use long radius elbows. Long elbows have been shown to have less pressure drop and greater strength. It is especially important to use long radius elbows to hot gas discharge lines.

Factory Supplied Stubs

Stub sizes provided from the manifolds do not automatically correspond to the line sizes necessary. It is the installer’s responsibility to supply reduction couplings.

INSULATION

All suction lines and subcooled liquid lines must be insulated. Subcooled liquid in the liquid line will warm if the lines are left unprotected, resulting in energy loss. Overtime this can lead to the liquid changing into a gas before it ever reaches the expansion valves. This is known as flashing. Flashing causes irregular flow through valves. If this occurs significant refrigerant loss and poor energy performance will occur. Compressor motors will fail if the suction line gas is too warm as it enters the compressors. For gas defrost applications, insulated suction lines help maintain temperature during defrost. Insulated lines also prevent sweating of the lines, thus eliminating drops of water on the floor below the line runs.

SPECIAL PIPING FOR OPEN ROOMS

An open food preparation room allows heat infiltration from the rest of the store at a rate which may jeopardize total refrigeration performance. To protect the rest of the refrigeration system, open preparation evaporators must be piped with a crankcase pressure regulating valve (CPR). The CPR is field installed in the suction line(s) from the

evaporator(s). And the installer is responsible for proper adjustment of the valve. (See CPR Valve Section for adjustment procedures.)

CONNECTING PARALLEL 3-WAY VALVES

Due to the size limitations of 3-way valves, some of the larger Koolgas systems will require parallel connection to 2 suction stubs at the header using an offset tee construction. Do not use a bull head tee.

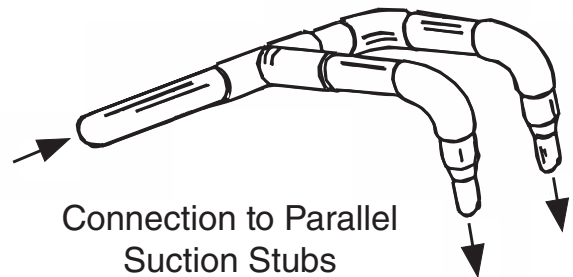

RUN LENGTHS AND EQUIVALENT FEET

When figuring run lengths, angle valves and 90 degree elbows are figured as additional straight pipe. The chart below gives equivalent lengths for these.

Equivalent Feet for Angle Valve and 90° Elbow		
Tubing Size	Angle Valve	Long Radius Elbow 90°
1/2	6	0.9
5/8	7	1.0
7/8	9	1.4
1 1/8	12	1.7
1 3/8	15	2.3
1 5/8	18	2.6
2 1/8	24	3.3
2 5/8	29	4.1
3 1/8	35	5.0
3 5/8	41	5.9
4 1/8	47	6.7

RACK TO CONDENSER PIPING

Discharge line will be routed directly to the condenser inlet stub with a purge valve at the highest point. Liquid return line will be pitched downstream, and purge valve location will provide trapless drainage to the rack.

PURGE VALVE LOCATION

The purge valve will be installed at the highest point of an inverted waterseal, with at least a 6 in. rise. (Use with approved recovery vessel.)

RECEIVER SAFETY RELIEF VALVE

The receiver safety relief valve must be properly vented in accordance with local codes.

NOTE:

Liquid return lines must be free draining with no traps. Install solenoid valves inside equipment room. All interconnecting valving to be field supplied and installed.

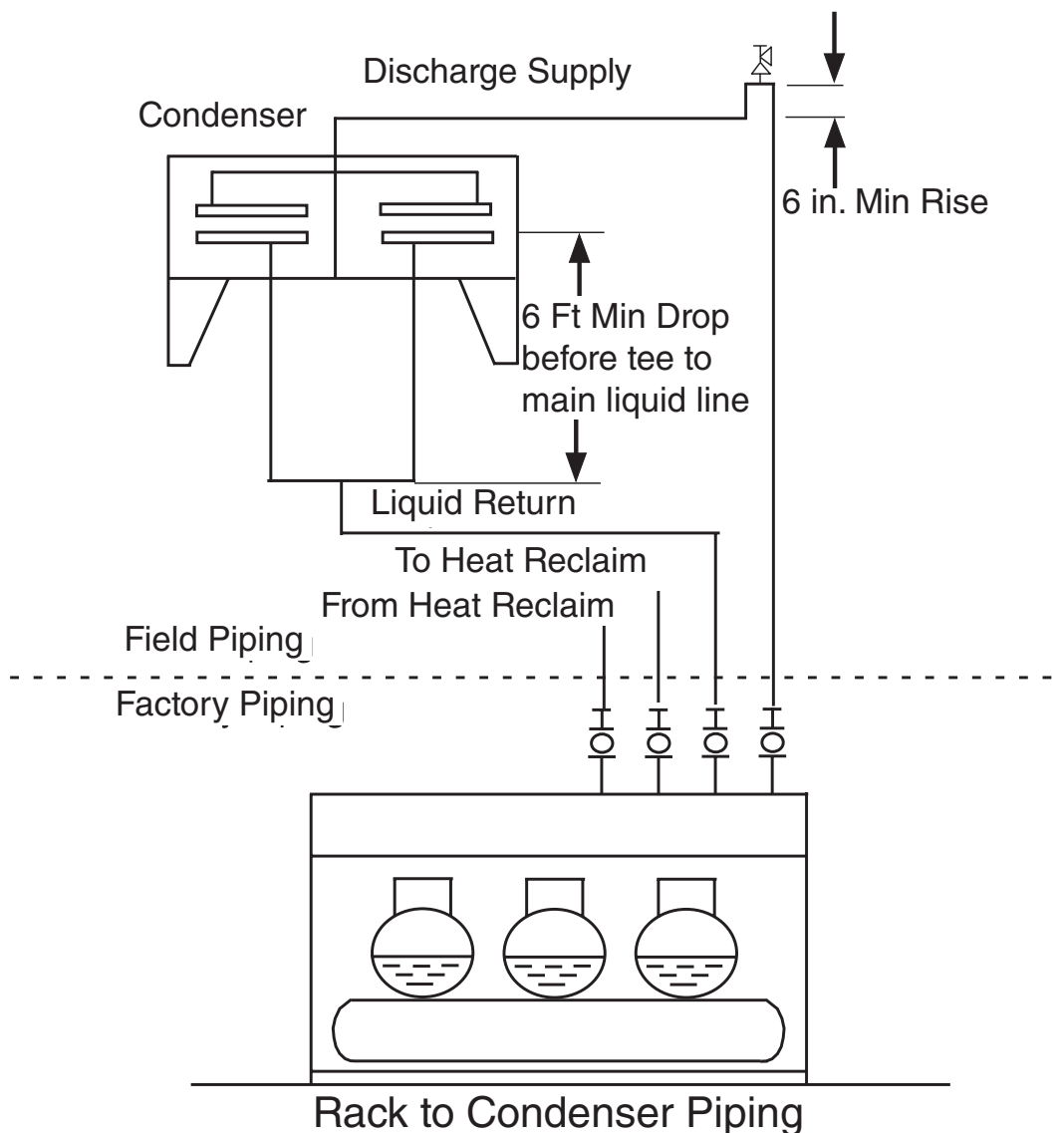

CONNECTING TO TWO MANIFOLDS

The discharge line will be “tee’d” upstream of the manifolds into expansion offsets with at least a one foot drop to the manifolds. Provide a purge valve at the highest point. The liquid return lines will be “tee’d” into the main liquid return line after six feet of vertical drop from the outlet stubs. The liquid return line will be pitched downstream, and provide trapless drainage to the rack.







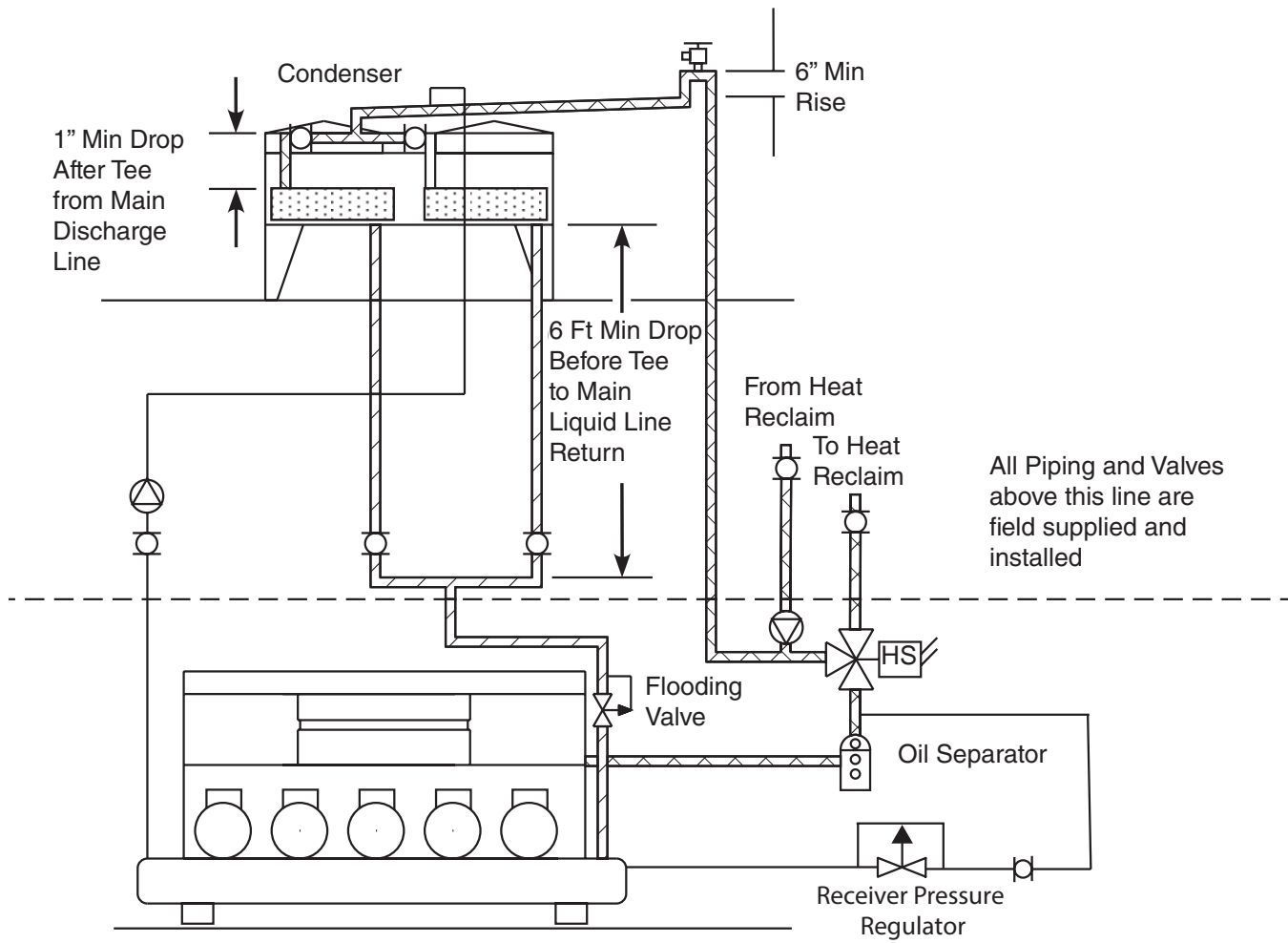

EQUALIZING LINE

An equalizer line is piped between the parallel rack and the condenser. A check valve allowing flow only to the condenser and a shut off valve downstream of the check valve will be field supplied and installed.

Condenser Piping w/ Heat Reclaim



All Piping and Valves above this line are field supplied and installed

- | | | |
|---|---|---|
|  Discharge Lines |  Ball Valve |  Condenser Manifold |
|  Liquid Return Lines |  Check Valve |  Valve Solenoid |
|  Equalizing Line |  Service Valve | HS = Heat Reclaim |
| |  Purge Valve | |

Note:

- Liquid Return Lines must be free draining with no Traps
- Install Ball valves to isolate Condenser (Field Supplied and Installed)
- All Interconnecting Valving to be Field Supplied and Installed

Split Condenser Piping 2 Solenoid Valve Method w/Heat Reclaim

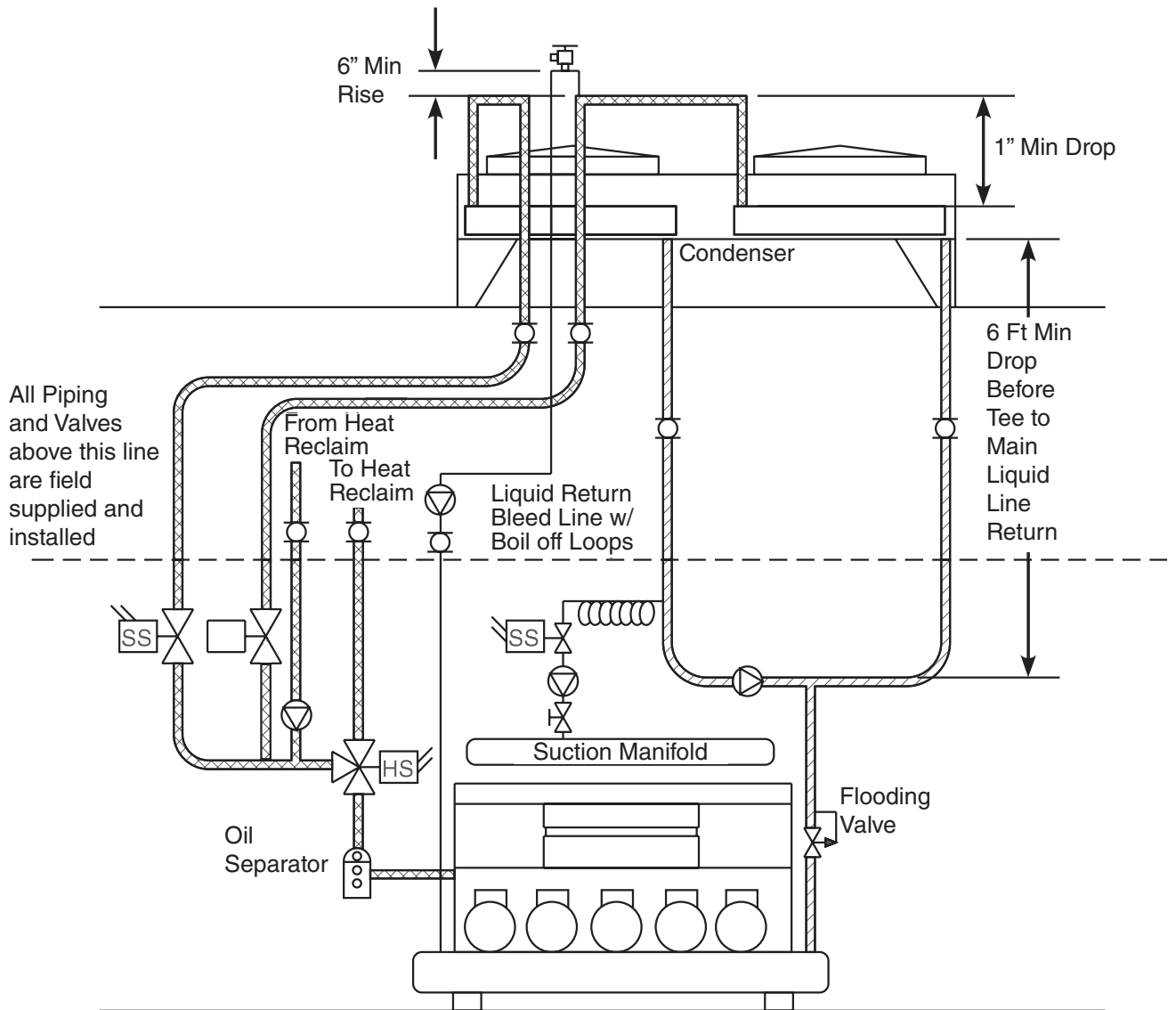

Discharge Lines	Ball Valve	Condenser Manifold
Liquid Return Lines	Check Valve	Valve Solenoid
Equalizing Line	Service Valve	HS = Heat Reclaim
1/4" Tubing	Purge Valve	PD = Pump Down
		SS = Split Condenser

Note:

- Liquid Return Lines must be free draining with out Traps
- Install Solenoid valves to isolate Equipment Room
- Pump down Line should not enter the Suction Manifold over a Compressor Inlet
- Install Ball Valves to isolate condenser
- All Interconnecting Valving to be Field Supplied and Installed

COMPONENT PIPING & LINE SIZING

Split Condenser Piping
3-Way Valve Method
w/Heat Reclaim

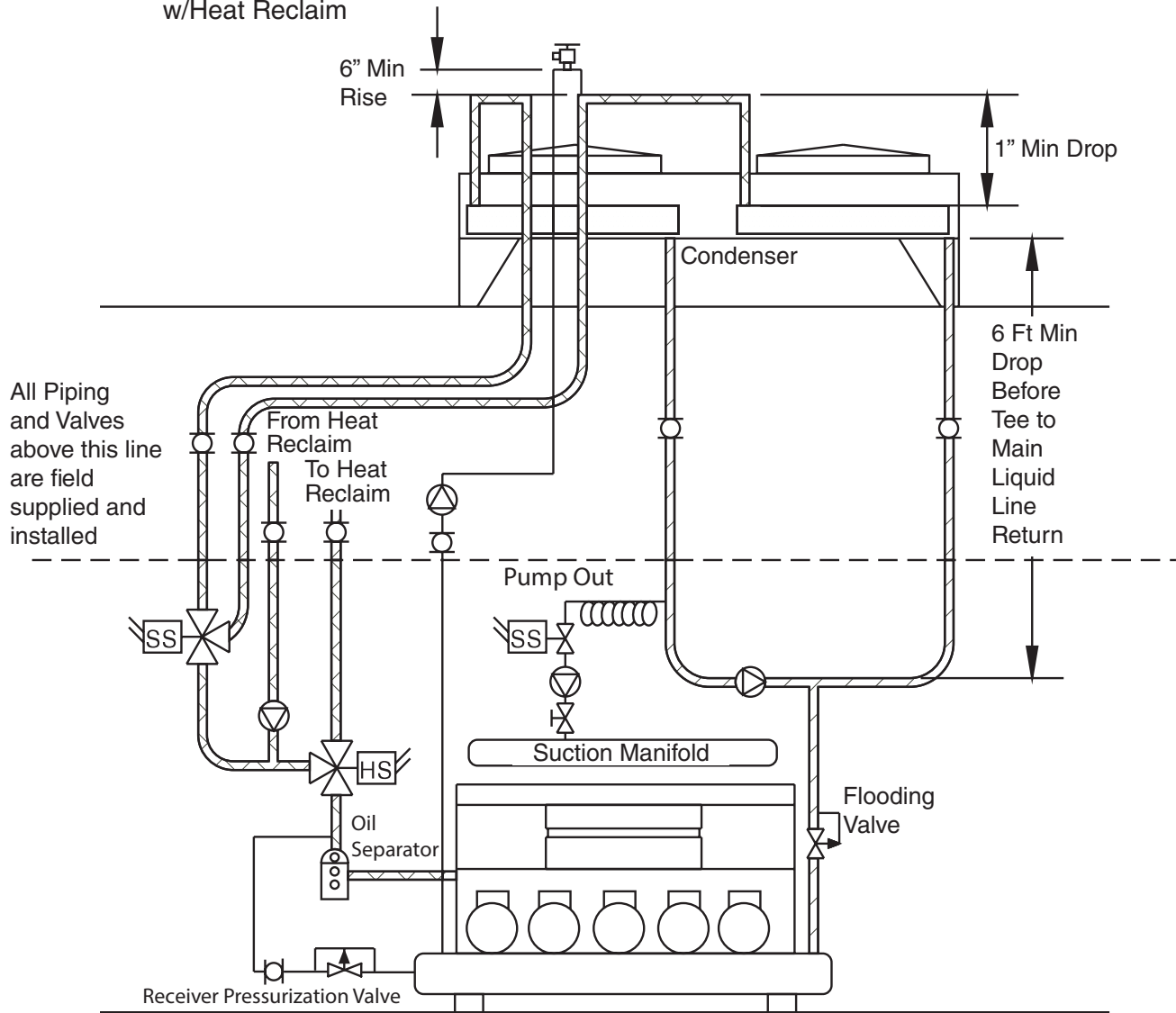

- | | | | | | |
|--|---------------------|--|---------------|----------------------|--------------------|
| | Discharge Lines | | Ball Valve | | Condenser Manifold |
| | Liquid Return Lines | | Check Valve | | Valve Solenoid |
| | Equalizing Line | | Service Valve | HS = Heat Reclaim | |
| | 1/4" Tubing | | Purge Valve | PD = Pump Down | |
| | | | | SS = Split Condenser | |

Note:

- Liquid Return Lines must be free draining with no Traps
- Install Solenoid valves to isolate Equipment Room
- Pump down Line should not enter the Suction Manifold over a Compressor Inlet
- Install Ball Valves to isolate condenser
- All Interconnecting Valving to be Field Supplied and Installed

RACK TO HEAT RECLAIM

Because of the variety of heat reclaim systems, refer to the instructions accompanying the system to be installed at the site.

RACK TO REMOTE HEADER

Separates compressors from defrost and temperature controls. The rack suction stub is connected as directly as possible to the suction header. The rack liquid line stub is connected as directly as possible to the liquid header. If equipped with Koolgas defrost the rack Koolgas stub is connected as directly as possible to the Koolgas header manifold. Note: The remote header may use a double suction riser to aid in oil return.

RACK TO REMOTE SATELLITE

The compressor discharge line may be piped through a vibration absorber to its stub on the discharge header. The compressor suction line will be piped one of two ways depending on whether a low-end or high-end satellite is used. A low-end satellite suction line is piped to its check valve on the suction header, and from there to the evaporator. (If Koolgas defrost is used pipe through the proper Koolgas valve.) A high-end satellite is piped directly to the evaporator.

Discharge Lines for Two Satellites

Installations having two Satellites are “tee’d” together upstream of the discharge manifold. Use an offset tee construction. Do not use a bullhead tee.

Oil Lines for Remote Satellites

All oil lines are run in 3/8 copper. Lines will be installed securely and run under tapered cover plates when crossing walkways.

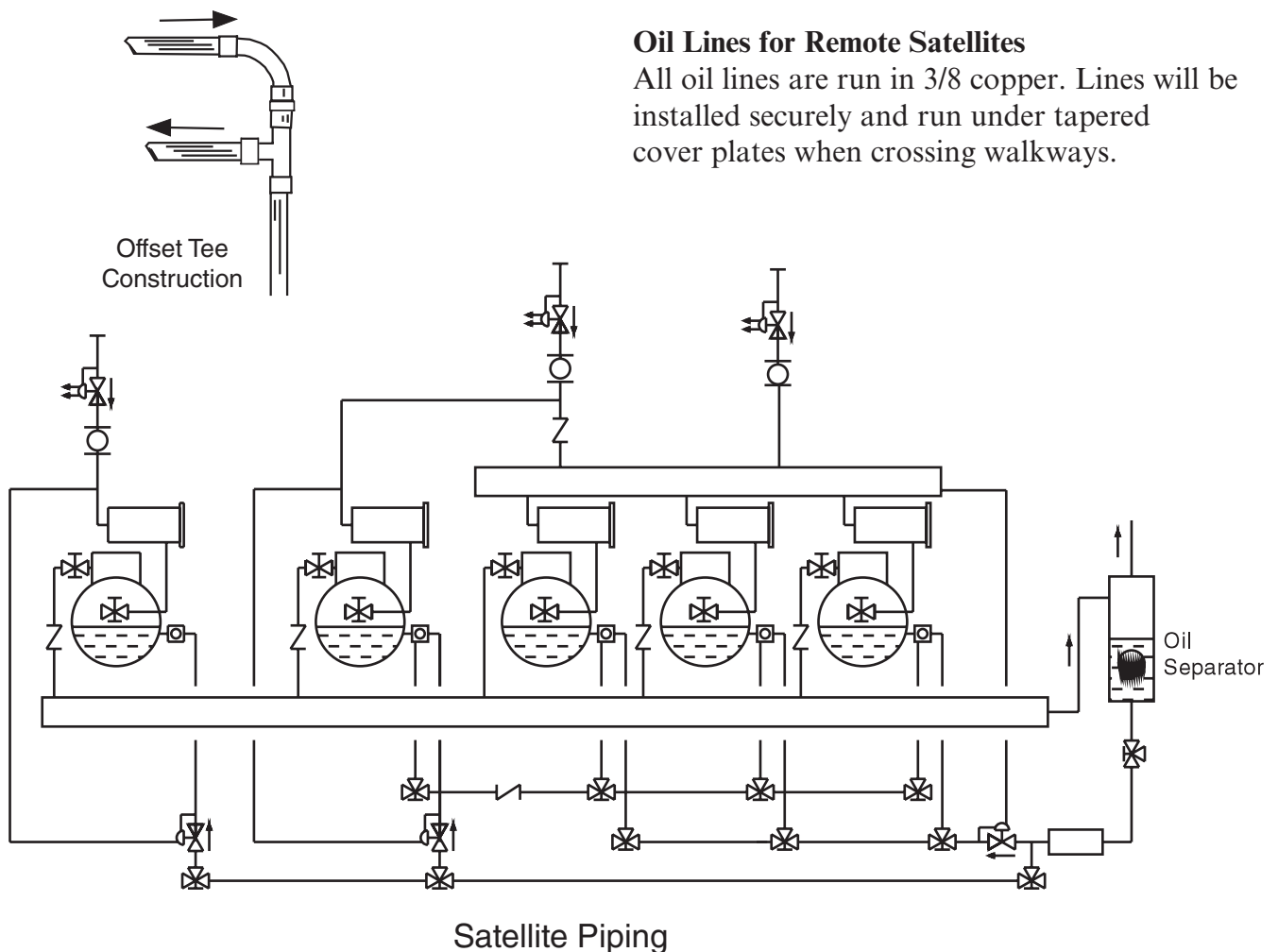

2-10 COMPONENT PIPING & LINE SIZING

OFFSET AND EXPANSION LOOP CONSTRUCTION

For low temperature applications multiply the length of the run in feet by 0.0169.

For medium temperature application multiply the length of the run in feet by 0.0112. The product will be inches of linear expansion for the length of run.

Examples: Low temperature application, a run of 84 ft of 1 3/8 in. OD.

$$84 \text{ ft} \times .0169 = 1.4196 \text{ inches expansion.}$$

Select the smallest “Inches Expansion” figure equal to or greater than the product in step one from the table below. Follow that column down until it intersects the OD line size of the run. The number listed at the intersection is the “L” value for figuring offset an expansion loop sizes.

Equivalent Feet for Angle Valve and 90° Elbow				
Inches Expansion				OD Line Size
0.5	1.0	1.5	2.0	
10	15	19	22	7/8
11	16	20	24	1 1/8
11	17	21	26	1 3/8
12	18	23	28	1 5/8
14	20	25	31	2 1/8
16	22	27	32	2 5/8
18	24	30	34	3 1/8
20	28	34	39	4 1/8

Example:

The smallest “Inches Expansion” equal to or greater than 1.4196 is 1.5. The 1.5 column intersects with the 1 3/8 line at 21. Use “L” value 21. For an offset multiply the “L” value by 3 to determine the length of the offset.

Example: An “L” value of 21 would mean $3L = 3 \times 21$ or $3L = 63$.

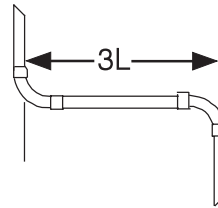

Offset Construction

The offset distance required for low temperature application for an 84 ft run of 1 3/8 line is 63 inches. For an expansion loop multiply the “L” value by 2 if hard copper and long radius elbows are used. If the expansion loop is formed in soft copper the loop diameter equals “L.”

Example: For the same 84 ft run, a hard copper loop is 42 by 42 inches. A soft copper loop is 21 by 21 inches.

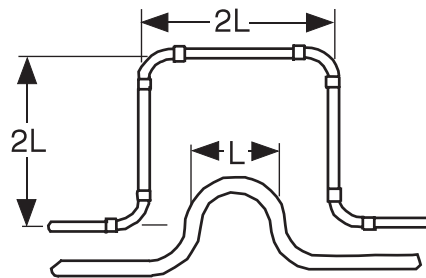

Expansion Loop Piping

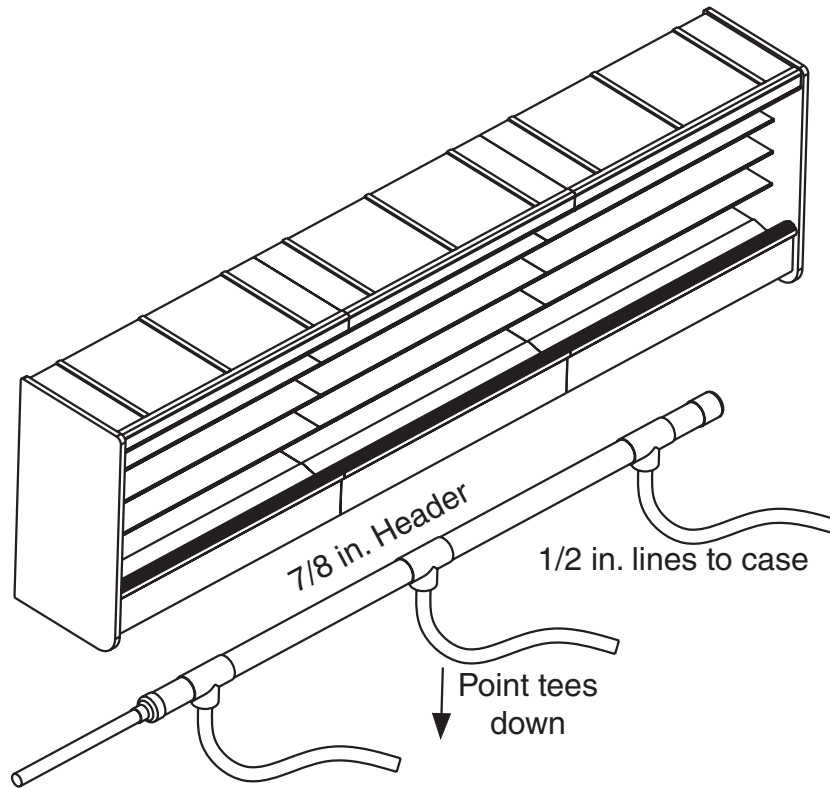

Application

Do not exceed a straight run for 100 feet without constructing an offset or expansion loop. Place the offset or loop in the middle of the run to minimize pipe shift and joint stress.

NOTE:

Sizing of all refrigerant lines is the responsibility of the installing contractor. Contact Hussmann, Application Engineering if assistance is needed.

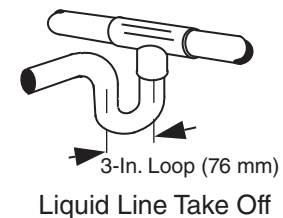
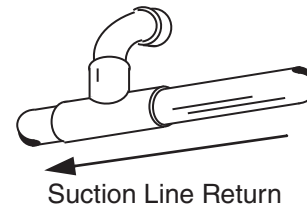

BRANCH LINE PIPING

Suction line

Pitch in the direction of flow. Line size may be reduced by one size at one third of case run load and again after the second third. Do not reduce below evaporator connection size. Suction returns from evaporators enter at the top of the branch line.

Liquid Line - Off-time and Electric Defrost

May be reduced by one size after one half other case load run. Do not reduce below evaporator connection size. Take-offs to evaporators exit the bottom of the liquid line. Provide an expansion loop for each evaporator take-off. (Minimum 3-inch diameter.)

KOOLGAS DEFROST

Maximum of 24 ft of case per branch system, except for island / coffin cases — never more than 24 ft. Increase the liquid line size inside the case by two sizes over the branch size.

Take-offs to evaporators exit the bottom of the liquid line. Provide an expansion loop for each evaporator take-off. (Minimum 3 in.)

Branch Size	In Case Size
1/2	7/8
5/8	1 1/8
7/8	1 3/8
1 1/8	1 5/8
1 3/8	2 1/8

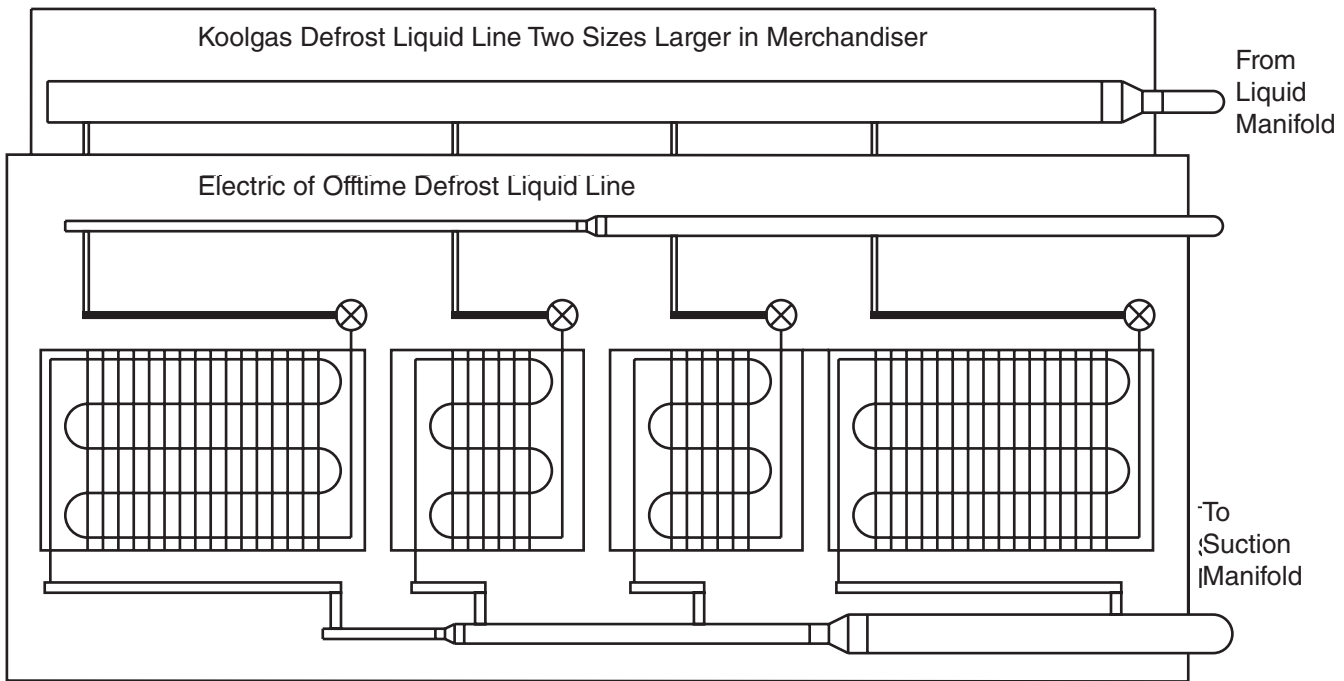

Refrigeration Line Stub Outs

Stub sizes do not match line sizes. Reduction fittings are field-supplied and installed. These are general guidelines. The installer is responsible to account for any factors which may affect the system.

*NOTE: This formula applies only to remote condenser lines, and only to longer runs of these lines. A 25 ft run does not necessarily have double the capacity of a 100 ft run.

Gas Defrost Systems

Do not use liquid lines smaller than 1/2 inch OD on any type of Gas Defrost system.

Condenser Line Sizing

A Condenser Line Sizing chart is established for an equivalent pipe run of 100 feet. For longer runs, use the following formula:

$$\begin{aligned}
 & \text{*Table Capacity} \times \sqrt{\frac{100}{\text{Longer Length}}} \\
 & = \text{Longer Line Capacity}
 \end{aligned}$$

REFRIGERATION

OVERVIEW

This section details the refrigeration process by tracking the refrigerant flow through the rack components. Oil separation and return is explained as well.

The rack is designed with an adequately-sized receiver for proper refrigerant management. The compact design reduces height and width requirements as well as providing convenient access to components for easy maintenance and service. In the diagrams refrigerant flow direction is generally clockwise and indicated by directional arrows. Electrical solenoid valves carry the same initial abbreviations as in the electrical schematics.

Refrigeration lines not actually in the cycle being discussed are shown closed or removed. Pressure oil lines will retain a fixed pattern.

BASIC REFRIGERATION CYCLE

Beginning with the parallel compressors, refrigerant vapor is compressed and flows to the oil separator and returned to the compressors. A 3-way valve directs the superheated discharge gas to either the condenser or a heat reclaim device when energized. When the reclaim solenoid is de-energized the valve directs the refrigerant to the condenser. The condenser rejects the heat that must be removed from the refrigerant to cause it to condense.



Oil Separator

The flooding valve maintains head pressure in low ambient conditions by restricting liquid refrigerant flow from the condenser.

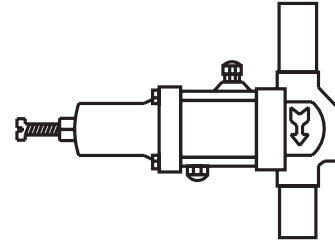

Flooding Valve

This causes liquid refrigerant flow to be backed up in the condenser, thus reducing available heat transfer surface and causing the discharge pressure to rise. The receiver is a holding vessel for liquid refrigerant. The receiver compensates for fluctuations in liquid requirements during changing loads, defrosts and weather.

The main liquid pressure differential valve functions during gas defrost to reduce pressure to the liquid header. The reduced pressure allows reverse flow of refrigerant gas through the evaporator necessary for an effective defrost.

The liquid header distributes liquid refrigerant to all branch liquid lines. The branch liquid line solenoid valve closes off refrigerant supply to the evaporator. The valve also allows back flow of refrigerant into the liquid header.



... ATTENTION
INSTALLER

**It is the installing contractor's
responsibility to consult local agencies
for local code requirements.**

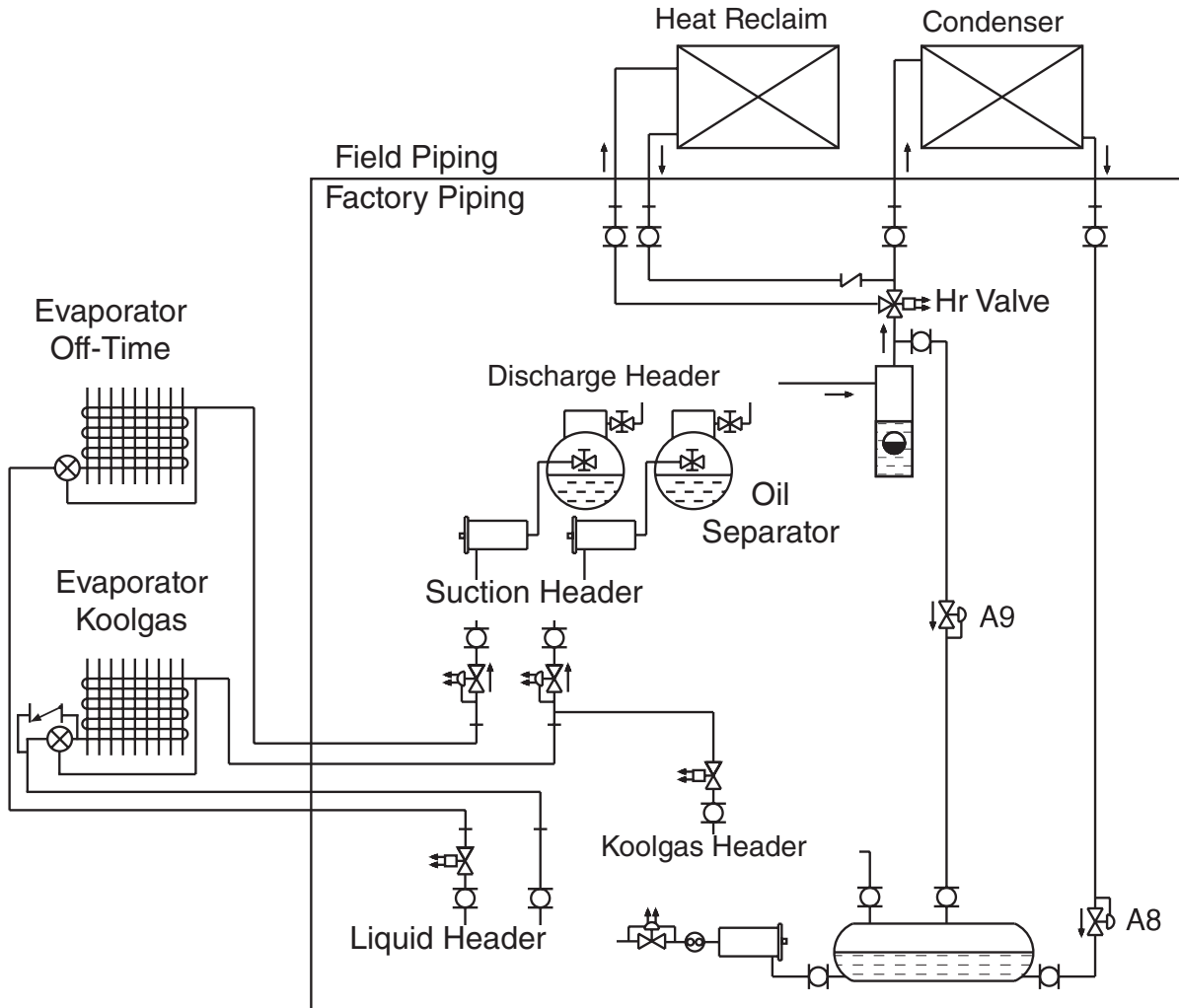

Custom System Refrigeration

THERMOSTATIC EXPANSION VALVE (TEV)

The Thermostatic Expansion Valve (TEV) regulates refrigerant flow into the evaporator by responding to the temperature of superheated vapor at the outlet of the evaporator, and in some cases where a TEV is used with an external equalizer. The TEV also responds to the pressure at the outlet of the evaporator.

The TEV, located in the merchandiser, meters liquid refrigerant through its orifice to the low pressure side of the system where it absorbs heat from the coil causing the liquid to evaporate.

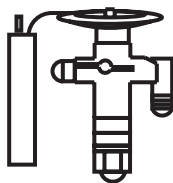

Thermostatic Expansion Valve

An evaporator pressure regulator (EPR) may be used to control the evaporator temperature by preventing the evaporator pressure from dropping below a preset pressure.

At critical locations along the refrigerant path, service valves or ball valves allow isolation of components.

Primary Method for Setting Expansion Valve Superheat:

- Measure the temperature of the suction line at the point the bulb is clamped.
- Obtain the suction pressure that exists in the suction line at the bulb location or by either of the following methods:
 - (1) If the valve is externally equalized, a gauge in the external equalizer line will indicate the desired pressure directly and accurately.

OR

(2) Read the gauge pressure at the suction valve of the compressor.

- Add the estimated pressure drop through the suction line between bulb location and compressor suction valve. The sum of the gauge reading and the estimated pressure drop will equal the approximate suction line pressure at the bulb.
- Convert the pressure obtained in (1) or (2) above to saturated evaporator temperature by using a temperature-pressure chart.
- Subtract the two temperatures obtained from these — the difference is superheat.

Secondary Method for Setting Expansion Valve Superheat:

- Before attempting to set a TEV be sure the merchandiser is within 10°F of its normal operating range.
- Attach temperature probes at both the TEV bulb location (under the clamps) and between the TEV and the evaporator inlet.
- While the valve is hunting the temperature difference between the two probes should not exceed 3-5°F. The differential may fall to zero. To reduce differential, turn the adjusting stem counter clockwise and wait at least 15 minutes before checking results.

HEAT RECLAIM CYCLE

The heat reclaim system returns heat to the store that has been removed from the refrigeration units. This heat, which would otherwise be wasted, is returned in useable form through a heat reclaim coil.

The heat reclaim 3-way valve energizes during reclaim mode diverting discharge gas to a remote mounted air reclaim coil or water heating coil or other heat exchanger. After the discharge gas passes through the reclaim coil, it returns to the system through a check valve and then to the condenser. The check valve assures no back flow and flooding when heat reclaim cycle is off. During heat reclaim, the heat reclaim coil rejects superheat from the refrigerant vapor and the condenser coil rejects latent heat and produces quality liquid for the refrigeration process. The heat reclaim coil should not be oversized.

HEAT RECLAIM VALVE

A 3-Way Heat Reclaim Valve directs the refrigerant to either the Condenser or a Heat Reclaim Coil. When the solenoid is de-energized the valve directs the refrigerant to the condenser.

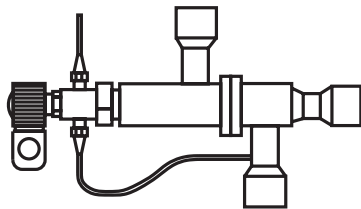

Heat Reclaim Valve

When the solenoid is de-energized the high pressure inlet is stopped and the passage between suction and valve chamber is open. When the solenoid is energized the suction outlet is stopped and the passage between high pressure and the valve chamber is open. Some manufacturers of the valve has a bleed port through the drive piston to the suction manifold. The bleed port provides a vent for fluids trapped in the heat reclaim circuits during normal operation.

There are three types of heat reclaim water, air, glycol. Water uses a special water tank that pre-heats water to 140°F. This helps reduce electric output of gas fired hot water heater. Air heat reclaim allows the waste heat to be used to either heat the store ambient air or to preheat air prior to air-conditioning. Glycol heat reclaim allows glycol to heat a cold aisle or a side walk-in or fryer, etc.

FLOODING VALVE AND RECEIVER PRESSURE REGULATING VALVE

The Flooding Valve and the Receiver Pressure Regulating Valve work together, the operation of one effects the operation of the other. The flooding valve responds to upstream pressure from the condenser. The receiver pressure regulating valve responds to downstream pressure in the receiver.

The Pressure Regulator Valve responds to receiver pressure. If the receiver pressure drops below its set point, the valve opens, directing hot high pressure vapor to the receiver.

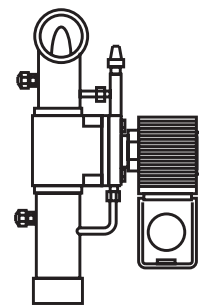

Pressure Regulator Valve

The Flooding Valve maintains head pressure in low ambient conditions by reducing the available condensing area. Restricting liquid refrigerant flow from the condenser, the flooding valve prevents the liquid refrigerant from leaving the condenser as fast as it is forming, so the condenser floods with its own condensate.

KOOLGAS DEFROST CYCLE

Beginning with the receiver the Koolgas cycle splits in two directions – receiver vapor and receiver liquid. The high pressure liquid flowing from the receiver is throttled by the main liquid line solenoid valve causing a pressure reduction in the liquid header.

If a branch liquid line solenoid valve is used on a Koolgas circuit, the liquid circuit is designed to allow backflow into the reduced pressure liquid header by an external parallel check valve or by a special solenoid valve designed to allow reverse flow. When a branch of refrigeration cases enters the defrost cycle its branch valve allows refrigerant to flow into the liquid header.

The receiver vapor flows directly into the Koolgas header. This Koolgas Vapor maintains the same high pressure as the receiver. A 3-way valve closes the suction line to the suction header and opens the Koolgas line to the evaporator. Koolgas vapor flows backward through the evaporator, giving up heat to the evaporator for defrost.

The Koolgas vapor condenses and flows into the reduced pressure liquid line through a Bypass check valve around the TEV. From there it is returned to the liquid line header. If a suction stop or EPR with suction stop is used to control evaporator temperature, the 3-way valve is not used.

When defrost is called for, the suction line control valve closes and a two-way Koolgas valves opens the line from the Koolgas header to the evaporator.

OIL SYSTEM

Discharge refrigerant carries droplets of oil from the compressors' lubrication system. The Turba-shed or other oil separator returns the oil from its reservoir along a high pressure line to the oil pressure differential regulator valve. This valve reduces the oil pressure to between 20 and 25 psig above the crankcase pressure of the compressor, providing even flow of oil to the oil level regulators or floats.

To balance oil level among the compressors an equalizing line returns any excess oil in one oil level regulator to the rest of the system. A check valve is placed in the equalizing line between the low end satellite and the rest of the system. The check valve is necessary to keep the low end satellite from filling up with oil. With a high end satellite, note that the satellite has no equalizing line.

Regulation Valve

The special oil pressure differential valve is used to reduce the high pressure in the combination oil separator and reservoir to a pressure slightly above the suction pressure to prevent overfeeding of the compressor float. The valve has an adjustment range of 3 to 30 psi differential pressure. Typically, this pressure should be approximately 20 to 25 psig above the suction pressure.

NOTE: Every suction group or satellite compressor should have its own pressure differential valve.

Adjustments are made at the bottom of the valve. To adjust, remove the valve cap and turn the stem with a valve wrench. To increase the differential, screw the stem in; to decrease the differential, screw the stem out. One turn gives 4 psi of adjustment.

NOTE: An increase in differential means higher oil pressure into the floats.

Oil Level Regulators

For any brand of oil level regulator to work accurately the unit and each compressor must be level. Both Sporlan and AC & R regulators may be damaged by over adjusting. Do not exceed 175 psig when testing to prevent damage to the floats. A sightglass filled with oil may indicate a damaged regulator. Before beginning adjusting, isolate the compressor by turning off its control circuit.

Sporlan Oil Level Control OL-1 Series

The Sporlan Oil Level Regulator comes preset to maintain oil level at the center line of the sightglass. If there is any question as to the actual set point of the regulator, turn the adjustment stem counterclockwise until the top stop is reached. Then adjust the oil level down to the desired height by turning the stem clockwise. Each full turn will represent about .05 inches change in oil level. Do not exceed nine turns from the top, or the control may be damaged.

Y825 VALVE ADJUSTMENT

- 1) Close all the oil float service valves. This is done by turning the valve stem in the clock wise direction until they bottom out.
- 2) Connect a low pressure gauge to the suction header.
- 3) Connect the low side gauge hose of a gauge manifold set to the schrader connection at the end of the supply oil manifold.
- 4) Connect the center hose of the gauge manifold set to the suction header.
- 5) Open the hand wheel on the gauge manifold set for a few seconds then close it off again.
- 6) Subtract the suction header pressure from the oil header pressure.
- 7) If adjustment is necessary, turn Y825 valve adjustment stem in the clock wise direction to increase pressure and turn it counter clockwise to reduce pressure. Always open the hand wheel on the gauge manifold for a few seconds and recalculate oil pressure after every adjustment.
- 8) Remove all gauges from the system.
- 9) Open all the oil float service valves.

AMBIENT SUBCOOLING

The surge valve directs flow of refrigerant from the condenser through the receiver (flow through), or around the receiver (surge) in response to ambient subcooling obtained in the condenser. During low ambient conditions the receiver pressure regulator will aid in maintaining pressure in the liquid header. The surge valve reacts to liquid temperature from the condenser.

When the liquid temperature is below 75°F, the surge valve will open allowing subcooled liquid to bypass the receiver into the liquid header. When the liquid temperature is above 75°F, the surge valve will close forcing liquid into the receiver and then into the liquid header.

The Surge Valve is controlled by a t'stat that closes on drop of liquid drain temperature. The correct setting may have to be adjusted due to lower flooding valve settings.

MECHANICAL SUBCOOLING

By lowering the temperature of the liquid supplied to the TEV, the efficiency of the evaporator is increased. The lower temperature liquid refrigerant produces less flash gas exiting the TEV. Since mechanical subcooling uses a direct expansion device, it is not limited by ambient temperature. A Liquid Line Solenoid Valve and a TEV control refrigerant to the subcooler. An EPR prevents the subcooler temperature from dropping below desired liquid temperature. Electrically, a thermostat responding to main liquid line temperature controls a solenoid valve on the liquid supply line.

TWO STAGE MECHANICAL SUBCOOLING

Due to wide ranges of load requirements, a two stage subcooling control will be used. In two stage subcooling, there are two expansion valves piped in parallel; one valve approximately one-half the size of the other.

The largest valve will be in operation during full load conditions. When the load requirements are reduced, the smaller valve will be turned on. At this time, the larger valve will be shut off. When the liquid drop leg reaches the subcooled liquid design point, both valves will be shut off.

Two-Stage Mechanical Subcooler Control

Electrically, a thermostat responding to liquid drop leg temperature will turn on the subcooler. The setpoint of this control will be the subcooling temperature design point.

The setpoint of the control for the one-half or full expansion valve is the liquid drop leg as well. This setpoint is determined by the expansion valve selection and will vary from store to store.

LIQUID INJECTION

The Liquid Injection System is designed to inject saturated refrigerant into the suction cavity when the compressor internal head temperature reaches the cut-in point. Injection continues until the temperature reaches the cut-out point. If the temperature remains above 310°F for one minute the control shuts down the compressor. After correcting the cause of shutdown, manual reset is required.

The System Parts:

Temperature Sensor Control Module Injection Valve.

The Temperature Sensor employs a Negative Temperature Coefficient (NTC) Thermistor to provide signals to the Control Module. The NTC resistance drops on temperature rise.

°F	Reading
77	90,000
282	2,420
292	2,110
310	1,660

Control Module responds to the Temperature Sensor input by energizing the Injection Valve Solenoid when the cut-in temperature is reached. Too high or too low a resistance from the thermistor circuit will cause the Module to shutdown the compressor after one minute.

Injection Valve meters saturated refrigerant into the suction cavity of the compressor. The valve orifice is carefully sized to meet the requirements of a specific compressor. Valve sizes correspond to the four compressor bodies – 2D, 3D, 4D and 6D by Copeland Compressor. Newer compressors equipped with “Core Sense” will not heed this option.

Component Testing

Remove power to the system. Unplug the Temperature Sensor from the Module. The Sensor should ohm out between 1,600 ohms and 100,000 ohms.

Leave the Sensor unplugged and restart the system. There should be no voltage between terminals “S” and “L2” on the Module. The inlet and outlet sides of the injection valve should feel the same temperature. After one minute, the alarm relay should trip. Remove power to the system. Press the manual reset on the Module.

Using a small piece of wire jump the Sensor circuit at the female plug in the module. Restart the system. There should be voltage between terminals “S” and “L2” on the module. The outlet side of the Injection Valve should feel colder than the inlet side. After one minute the alarm relay should trip.

Remove power to the system. Press the manual reset on the Module. Remove the jumper wire and plug in the Temperature Sensor. Restart the System.

Alarm Circuit

The Alarm Circuit has three terminals in the Control Module: “L” – Common; “M” – Normally Closed; and “A” – Normally Open. “L” and “M” are wired into the compressor control circuit so an alarm condition removes the compressor from the line and power to the Module. A manual reset is required to call attention the alarm condition.

Alarm Relay

The Alarm Relay is activated after a one minute delay under the following three conditions:

Compressor discharge temperature exceeds 310°F. A shorted circuit or very low Thermistor resistance. An open circuit or very high thermistor resistance. Operational notes liquid injection does NOT replace head cooling fans which are still required on low temperature applications. Temperature Sensor cable must not touch any hot surfaces or the cable will be damaged.

Liquid Injection Test

- 1) Turn off the compressor whose demand cooling module you want to test.
- 2) Unplug sensor from liquid injection module then turn compressor back on.
- 3) Once the compressor starts it should run for about one minute before locking out on liquid injection.
- 4) Turn off the compressor again, this time jump the temperature sensor at the demand cooling module.
- 5) Push the reset on the liquid injection module. When the compressor starts the liquid injection solenoid should be energized. The compressor should run for about one minute then lock out on demand cooling.

6) Turn off the compressor again, remove jumper and push reset button on the liquid injection module.

7) Plug the sensor back into the demand cooling module then turn compressor back on.

EPR VALVE

Evaporator pressure regulator valves respond to upstream pressure and are used to maintain a minimum evaporator temperature.

Two key points when working with rack mounted EPRs:

- Pressure drop from the merchandiser to the machine room. The final test for setting an EPR should always be evaporator discharge air temperature or product temperature.
- The second is that low pressure drop EPR valves, like those used on the rack, require an external high pressure supply to power the main piston chamber. This high pressure supply must maintain a positive

differential of at least 50 psig above the down stream side of the valves. Lower pressure differentials may cause valve malfunction.

Basically all EPR and ORI valves open on upstream suction pressure rise. Achieve the desired suction pressure by balancing Adjustment Spring (#1) against Upstream Suction Pressure (#2) and Fixed Pressure Counter Spring (#3). As upstream pressure rises it closes the high pressure inlet to the Main Valve Chamber (#4). The downstream bleed off reduces the Main Chamber pressure to the point that piston spring (#5) and Upstream Pressure (#6) open the main valve.

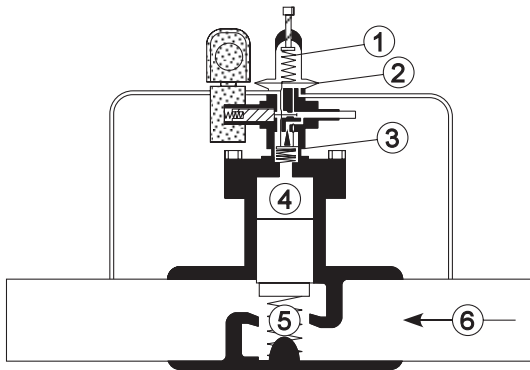

Figure 6-1 EPR Valve with Suction Stop Solenoid

Note:

EPR Valves equipped with a Suction Stop Solenoid are used with Koolgas Defrost. When de-energized, this solenoid causes the Main Valve to close.

CPR VALVE

The Crankcase Pressure Regulator protects the rest of the system from the large loads caused by open prep rooms. Installed in the suction line, this valve prevents down stream pressure from rising above a given point.

To set the CPR Valve:

- Attach compound gauges up and down stream of the valve and as closely as possible to the valve.
- Set the prep room temperature control low enough to be calling for cooling. Manually turn off one or more compressors on the rack to cause a suction pressure rise.
- Set the CPR to throttle at 35 psig, maintaining that pressure down stream. The up stream pressure will increase above 35 psig. Set the temperature control to 45°F discharge air temperature, or local codes.

NOTE:

If a CPR Valve does not operate or leaks around the adjustment screw, it generally must be replaced.

MAIN LIQUID LINE SOLENOID VALVES

The Sporlan Main Liquid Line Solenoid Valve goes into differential mode when the coil is de-energized or fails. When the Pilot Port (1) opens, upstream pressure (2) fills the Main Valve Chamber (3) and forces the Main Valve towards a closed position. The downstream pressure (4) falls to the point that the Pilot Valve Spring (5) can not keep the downstream outlet closed. The Main Valve Chamber starts to empty and upstream pressure forces the main valve towards open.

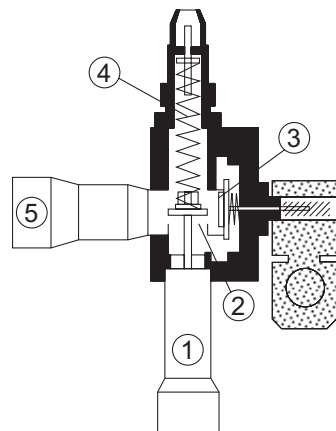

Differential Mode - Coil De-energized

Downstream pressure
+ pilot spring pressure
= upstream pressure

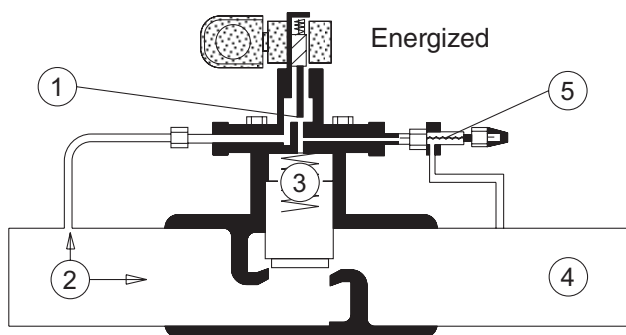

Figure 6-6 Sporlan main Liquid Line Solenoid

Differential Mode Quick Test

- Connect pressure gauges up- and downstream of the valve.
- All branches on the rack must be in refrigeration mode.
- Disconnect power to Solenoid.
- Check gauges for differential.

NOTE: Low refrigerant demand may prevent the differential from building up to the valve's real setting — upstream pressure.

BRANCH LIQUID LINE SOLENOID VALVES

The Branch Liquid Line Solenoid Valve closes off refrigerant supply to the evaporator, yet allows back flow of refrigerant into the Liquid Manifold for Koolgas Defrost.

When the Solenoid is de-energized the Valve Port (1) is held closed. Higher Pressure (5) upstream fills the Valve Chamber (3) through the Equalizing Port (4), keeping the Valve closed.

In refrigeration the Valve Port (1) opens, emptying Valve Chamber (3) through the Check Valve (2) faster than the Equalizing Port (4) can fill it. Higher Pressure (5) upstream forces the Valve open.

During Defrost, Valve Port (1) opens, removing kick spring force from the valve. Higher Pressure (5) downstream back flows, closing the Check Valve (2) and forcing the Valve up. Equalizing Port (4) allows Valve Chamber (3) pressure to escape upstream.

NOTE:

The Solenoid of the branch valve is energized during refrigeration and from back flow during defrost.

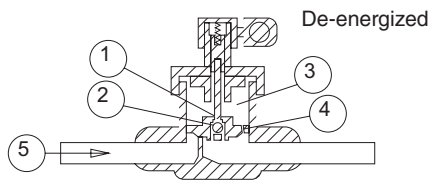
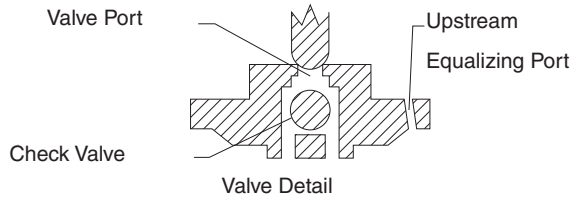

Branch Liquid Line Solenoid Valve

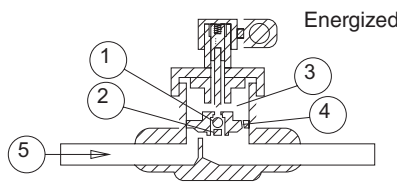

Refrigeration - Forward Flow

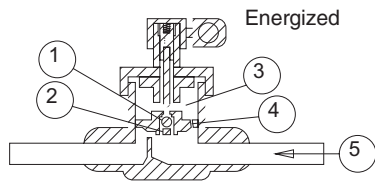

Defrost - Back Flow

3-WAY SPLIT CONDENSING VALVES

A 3-Way Split Condenser Valve directs the refrigerant to either both coils of a split condenser or one coil of a split condenser. When the solenoid is de-energized, the seat disc is in the position that evenly splits the flow between both coils of the condenser. When the solenoid is energized, the seat disc moves to close the upper port.

The refrigerant flow is then directed to the condenser coil that is set to operate all year. The “B” version of this valve has a small bleed port that pumps out the condenser coil that is not operating when the valve is energized.

Hussmann’s racks will have a split condenser pump-out on the liquid drop leg that consists of a solenoid valve in series with a small orifice expansion valve. When the split condenser valve is also energized, this solenoid valve is energized allowing for a quick pump-out through the expansion valve and through the bleed port of the 3-way valve.

SURGE RECEIVER VALVES

When the refrigerant temperature returning from the condenser drops below its set point, the surge valve directs the flow of refrigerant around energized (open) directing refrigerant flow around the Receiver (Surge) in response to ambient subcooling obtained in the condenser.

SUBCOOLING WITH PLATE HEAT EXCHANGER

The TEV should be set with the highest possible superheat that will still maintain the desired liquid temperature. EPR setting is listed on the store legend.

Electrically, a thermostat responding to main liquid line temperature immediately down stream of the plate subcooler controls a solenoid valve on the liquid supply line from the liquid manifold. This circuit is supplied with power through parallel auxiliary contactors on the compressor motor contactors.

A liquid line solenoid valve and a TEV control refrigerant flow to the plate heat exchanger.

An EPR on the return suction line prevents the subcooler temperature from dropping below desired liquid temperature.

Thermostat setting is 50°F with minimum differential, or customer specifications.

LIQUID LINE DIFFERENTIAL VALVE ADJUSTMENT

- 1) Shut off the Kool/Hot gas ball valve on the first gas defrost circuit and put that circuit in defrost. Make sure that no other circuits that are gas defrost, are in, or will go in defrost while adjustments are being made.
- 2) Connect two high side gauges, one on each side of the liquid line differential valve.
- 3) Subtract the outlet pressure from the inlet pressure, this is your differential pressure.
- 4) If adjustment is necessary, turn valve adjustment stem in the clock wise direction to increase the deferential pressure and turn it counter clock wise to reduce the deferential pressure.
- 5) Remove the high side gauges.
- 6) Take the first gas defrost circuit out of defrost and open the Kool/Hot gas ball valve for that circuit.

SORIT EVAPORATOR PRESSURE REGULATOR ADJUSTMENT

- 1) Connect a low pressure gauge to the suction manifold.
- 2) Connect a low pressure gauge to the evaporator side of the SORIT valve in need of adjustment.
- 3) Make sure the suction header pressure is 5 to 10 psig lower than the desired set point.
- 4) Turning the SORIT valve adjustment stem in the clock wise direction will cause the evaporator pressure to go up. Turning the stem in the counter clock wise direction will cause the evaporator pressure to go down.
- 5) Wait a few minutes to allow system pressures to stabilize then recheck the SORIT valve set point.
- 6) Remove the low side gauges.

LOW PRESSURE CONTROLS

- 1) Turn off the control circuit for the compressor that needs it's low pressure control set.
- 2) Bypass any time delays, electronic rack control relay, electronic overload module with built in time delay and switch back relay if used.
- 3) Connect a low pressure gauge to the suction header.
- 4) Front seat oil supply and oil equalizer line service valves on the compressor whose low pressure control is being adjusted.

- 5) Make sure rack suction pressure is above the desired cut in point of the low pressure control. You may have to turn off the other compressors to raise the suction pressure.
- 6) Connect a low pressure gauge to the compressor suction service valve on the compressor whose low pressure control is being adjusted.
- 7) Front seat the suction service valve.
- 8) Jump out the low pressure control and turn on the compressor. Look at the gauge connected to the suction service valve, when the pressure reaches 0 psig turn off the compressor.
- 9) Adjust the cut in point of the low pressure control 20 to 25 psig above the desired cut in point by looking at the scale on low pressure control.
- 10) Slowly open the suction service valve and watch the low pressure gauge. When the pressure reaches the desired cut in close off the suction service valve.
- 11) Remove the jumper on the low pressure control. Turn the compressor control circuit on. Slowly turn the cut in adjustment toward the desired cut in point. When the compressor turns on you have reached your desired cut in point.
- 12) Slowly open the suction service valve and watch the gauge connected to the suction service valve. Make sure the compressor cuts in at the proper pressure. If fine tuning of the low pressure control is needed, front seat the suction service valve again then adjust the cut in on the low pressure control.
- 13) Slowly open the suction service valve while watching the gauge connected to the suction service valve. Repeat until the desired cut in point is reached. When you are finished adjusting the cut in of the low pressure control open the suction service valve fully.
- 14) Turn the differential adjustment on the low pressure control to a value greater than your desired cut out point.
- 15) Slowly front seat the suction service valve while watching the gauge connected to the suction service valve. When the desired cut point is reached stop turning the suction service valve.
- 16) Slowly turn the differential adjustment on the low pressure control towards the desired cut out point. When the compressor turns off you have reached your desired cut out point.
- 17) Open the suction service valve fully then begin to front seat it while watching the gauge connected to the suction service valve. Make sure the compressor cuts out at the proper pressure. If fine tuning of the low pressure control is needed, adjust the cut out on the low pressure control. Repeat this step until the desired cut out point is reached. When you are finished adjusting the cut out of the low pressure control open the suction service valve fully.

CONTROL SETTINGS GENERAL DESCRIPTION

- 18) Disconnect the low pressure gauges from the system.
- 19) Open oil supply and oil equalizer line service valves that were closed during Step 4.
- 20) Turn off the control circuit on the compressor whose low pressure control you set.
- 21) Remove any jumpers you installed during Step 2.
- 22) Turn the compressor control circuit back on.

There are ten potential control settings required to be set up prior to startup. They are as follows:

- Low Pressure Controls
- Satellite Pressure Controls
- Compressor Oil Failure Controls
- Heat Reclaim Lockout
- Split Condenser Control Settings
- Condenser Settings
- Winter Condensing Pressure Controls
- EPR Pressure Settings
- Defrost Timer Settings
- Inverter Settings

High Pressure Control Adjustment

- 1) Set the cut out of the high pressure control to the desired set point. Use the scale on the high pressure control to set cut out point.
- 2) Set the cut in of the high pressure control to the desired set point. Use the scale on the high pressure control to set cut in point.

3-16 REFRIGERATION

NOTES:

ELECTRICAL

ELECTRICAL OVERVIEW

Custom wiring schematics are located on the doors of each rack. Racks are wired for 208-230/3/60 or 460/3/60. Other voltages are available upon request. The control circuit is typically 208VAC but racks can be ordered with a single point connection (optional). Refer to the serial plate located on the control panel to determine MCA MOPD.

Refer to merchandiser Data Sheets for electrical supply requirements for cases.

FIELD WIRING

Rack components are wired as completely as possible at the factory with all work completed in accordance with the National Electrical Code (NEC). All deviations required by governing electric codes will be the responsibility of the installer.

The lugs on the circuit breaker package in the compressor control panel are sized for copper wire only. All wiring must be in compliance with governing electrical codes.

For Remote Header Defrost Assembly:

To the defrost control panel, provide one 208V, 1PH and 15A branch circuit, or one 120V, 1PH and 15A branch circuit for control power only. One 208V 3PH branch circuit for electric defrost power, one communications circuit for electronic controller output/input boards. The 120V and 208V circuits may originate at the parallel rack or from a separate source.

Consult the store legend or electrical plans for each installation.

For 208-230/3/60 Compressor Units:

To each parallel rack compressor, provide one 208-230/3/60 branch circuit, one 120V or one 208V, 1PH and 15A circuit. Omit when single point connection kit is used.

Provide one 208-230/3/60 branch circuit to each remote air-cooled condenser. Dry contacts are made available upon request at the rack control panel. Contacts will close in alarm state. Contact rating is 10A at 208V. Alarm status may be configured through an electronic controller.

REQUIRED FIELD WIRE SIZE

Based on the full load amps of the system, select the largest connectable wire size from the table. (Based on no more than three wires in the wireway and 30°C environment per NEC.) Total Connected FLA Largest Connectable Wire:

140A (max)	00 per
248A (max)	350 mcm
408A (max)	2x (250 mcm) per
608A (max)	2x (500 mcm) per

Include control circuit amps if single point connection transformer option is used. 12A for 208V systems 6A for 460V systems (Refer to NEC for temperature duration factors.)

MERCHANDISER ELECTRICAL DATA

Technical data sheets are included with this manual. The data sheets provide merchandiser electrical data, electrical schematics, parts lists and performance data. Refer to the technical data sheets and merchandiser serial plate for electrical information.

MERCHANDISER FIELD WIRING

Field wiring must be sized for component amperes stamped on the serial plate. Actual ampere draw may be less than specified. Field wiring from the refrigeration control panel to the merchandisers is required for defrost termination thermostats and for optional refrigeration thermostats. When multiple merchandisers are on the same defrost circuit, the defrost termination thermostats are wired in series.

ELECTRICAL CONNECTIONS

All wiring must be in compliance with NEC and local codes. All electrical connections are to be made in the electrical wireway or *Handy Box*.

IDENTIFICATION OF WIRING

Leads for all electrical circuits are identified by colored plastic bands. These bands correspond to the *color code sticker* (shown below) located inside the merchandiser’s wireway cover.

The defrost heaters, defrost termination thermostats and refrigeration thermostats on the wide island models are tagged with identification as being either front or rear merchandiser display section defrost and refrigeration controls.

ALWAYS CHECK THE SERIAL PLATE FOR COMPONENT AMPERES.

WIRING COLOR CODE

Leads for all electrical circuits are identified by a colored plastic band: neutral wire for each circuit has either White insulation or a White plastic sleeve in addition to the color band.

<p>PINK REFRIG. THERMOSTAT LOW TEMP.</p> <p>LIGHT BLUE. REFRIG. THERMOSTAT NORM TEMP.</p> <p>DARK BLUE. DEFROST TERM. THERMOSTAT</p> <p>PURPLE CONDENSATE HEATERS</p> <p>BROWN FAN MOTORS</p> <p>GREEN* GROUND</p>	<p>ORANGE OR</p> <p>TAN LIGHTS</p> <p>MAROON RECEPTACLES</p> <p>YELLOW DEFROST HEATERS 120V</p> <p>RED DEFROST HEATERS 208V</p> <p style="text-align: center;">*EITHER COLORED SLEEVE OR COLORED INSULATION</p>
--	--

ELECTRICIAN NOTE: Use copper conductor wire only.

CASE MUST BE GROUNDED

ELECTRICAL DIAGRAMS

All electrical schematics reflect the standard ladder diagram. Electrical schematics are included with each rack. Please keep in mind all diagrams in this manual are only examples! Wiring may vary, refer to the diagram included with each rack. To focus on circuit logic the diagram may separate a relay coil and it's contacts. Electrical terminal connections are clearly numbered and aid in trouble shooting should a problem arise.

Unit Cooler Fan Wiring

See manufacturer's literature for wiring requirements. Evaporator mounted liquid line solenoid power for a liquid line solenoid can be picked up at the rack on terminals C and R for each respective circuit.

Cooler Door Switch Wiring

Check the store legend for door switch requirements. The switch must be mounted to the cooler door frame, and must be wired to control the field installed liquid line solenoid and the fan circuit. For Koolgas applications, install a check valve to bypass the liquid line solenoid valve.

COMPONENT WIRING GUIDELINES

Check the store legend for components requiring electrical circuits to either the panel, which may include:

- Remote alarm
- Electronic temperature probe
- Defrost termination thermostat
- Thermostat controlling a liquid line solenoid
- Satellite control
- Heat reclaim contact or 24V supply

All thermostat wires should be sized for rack control circuit breaker. Temperature sensor

wiring should refer to the controller manufacturer's literature. Check field wiring requirements for appropriate quantity of wires.

Sizing Wire and Overcurrent Protectors

Check the serial plate for minimum circuit ampacity (MCA) and maximum overcurrent protective devices (MOPD). Follow NEC guidelines.

Other Controls

Refer to the wiring schematics included with the rack, when other controls are used.

COMPRESSOR CONTROL

Each control panel is wired with independent compressor control circuits so any compressor can be electrically isolated without causing the other compressors to be shut down. A typical compressor control will consist of the following:

- Electrical control
- Switchback relay contacts (optional)
- Switchback time delay (optional)
- Low pressure switch
- High pressure switch
- Oil pressure switch
- Overload contact (if used)
- Contactor coil
- Demand cooling control (if used)
- Crankcase heater (optional)
- Lighted toggle switch

Terminal pins will be used between control points for easy testing and troubleshooting.

ELECTRONIC CONTROLLER

The electronic controller uses a suction transducer to “read” the suction manifold pressure. From this, sequence compressors on or off through a relay board to achieve the target suction pressure.

TIME DELAY

Automatic time delays are built into most electronic controllers. This helps avoid short cycling. A solid state time delay will be used for backup in the unlikely event of a electronic controller failure. The time delay will only be in the circuit during switch back, if the system uses switch back control.

If the system does not have optional switch back control then it will be wired in series with the operating controls. Awareness of time delays will reduce frustration and confusion when starting or troubleshooting the system.

PRESSURE SWITCHES

There are basically three pressure switches in the compressor control circuit. A low pressure switch is used to close the control circuit during high suction and open the circuit during low suction pressure. A high pressure switch is used to open the control circuit during a critical high discharge pressure state. The high pressure switch is available in automatic or manual reset. An oil pressure switch senses the supply oil pressure when the compressor is running.

If the oil pressure falls below the preset setting, the control circuit will open. Oil pressure switches are preset for 6.5 psig differential (Carlyle) and 9 psig differential (Copeland). The oil failure time delays are preset for 45 seconds (Carlyle) and 120 seconds (Copeland).

*For proper setting of switches see control settings section.

SWITCHBACK CONTROL (OPTIONAL)

During “normal” operation, the switchback relay will be de-energized allowing the electronic controller to be in full control. When the controller loses power or malfunctions, the switchback relay will energize which in turn will bypass the control power around the electronic controller and through the low pressure switch and time delay.

CRANKCASE HEATERS (OPTIONAL)

A crankcase heater is used to alleviate liquid migration to the compressor during off cycle periods. The crankcase heater is interlocked through the compressor contactor to be powered when the compressor is not running.

OIL FAILURE RELAY

This relay is used during an oil failure to jump the electronic controller relay. This will eliminate multiple alarms if the suction pressure drops and the compressor control point opens without the oil failure relay, the suction pressure would eventually rise causing another oil failure alarm.

CURRENT RELAY (OPTIONAL)

A current relay is wired in series with the oil failure control heater. This will prevent a false oil trip if the compressor circuit breaker should trip or if the compressor goes off on internal overload.

DEFROST CONTROLS

There are many types of defrost circuits and they are shown on the Defrost diagram in the rack. These circuits may be repeated in multiple and intermixed in any one store. Each control panel is wired with independent defrost control circuits so any circuit can be electrically isolated without causing the other circuits to be shut down.

A typical defrost circuit will consist of the following:

- Lighted toggle switch.
- Pins R and C for refrigeration power circuit.
- Pins D and C for defrost power circuit.
- N.C. contacts for refrigeration.
- N.O./N.C. contacts for defrost.
- Pins E and F for defrost termination. (Dry contact only)
- Pins T and B for temperature control thermostat (Dry contact only) or Temperature probes can be used for electronic controllers.

Refrigeration Mode:

During refrigeration, both the defrost point and refrigeration point are de-energized allowing L1 power to flow to the SV valve (Sorit or Liquid Solenoid). If case probes are used with the controller the refrigeration point will open when a system reaches proper operation temperature. Thus closing the refrigeration valve.

Defrost Mode:

The defrost point will energize opening power to the SV valve, refrigeration point. and closing power to the Kool/Hot gas valve (HGV) or defrost contactor (DC).

TEMPERATURE CONTROLS

Refrigeration Thermostat (Alternate)

If it is desired to have the refrigeration thermostat operate the branch liquid line solenoid on the compressor unit, wire it to the control panel in the following manner. Determine the system number from the store legend. The system will be on the suffix of the appropriate "T" and "B" terminals.

- a. Remove the jumper from the T and B terminal.
- b. Connect one thermostat wire to the T terminal.
- c. Connect the other thermostat wire to the B terminal.

Case Probe (Alternate)

If it is desired to monitor case temperature and operate a branch liquid line circuit, wire a case probe from the case to an analog point on the electronic controller. Provisions for case probes may be made from the field or factory. Refer to the controller manual for setup.

Defrost Termination Thermostat

For each system using defrost termination thermostats, run a two-wire control circuit from all termination thermostats (in series, one per case) to the E_ and F_ terminals in the control panel with a suffix corresponding to the system number.

Note: The defrost termination thermostat must supply a dry contact closure. An isolation relay must be used for a "hot" termination thermostat.

Master Defrost Valve

The master defrost valve is used during a hot/kool gas defrost cycle to create a reverse flow through the evaporator.

ALARM CONTROL

Alarm System

The rack basic alarm package includes alarms for:

- Oil Failure (each compressor)
- Phase Loss
- Low Liquid Level*
- High Suction*
- High Discharge
- Compressor Failure

*Time Delayed

A dry set of contacts are supplied to control a remote bell or other alarm device. These contacts are rated at 10.0 amps, 120V. An indicator light signifies what alarm condition has been activated.

Note: If an electronic rack controller is utilized, then the above alarms will be performed by the rack controller.

Ladder diagrams emphasize the circuit continuity and logic. They aid troubleshooting and testing by identifying point-to-point connections, and color coding rather than just physical location. A ladder diagram normally moves from left to right so the user can “read” the series of switches, relays, terminals and components that make up a circuit.

Alarm Control (Electronic)

When an Electronic Rack Controller is utilized all alarm functions are performed by the rack controller. High suction and high discharge pressures are “read” by transducers connected to the rack controller. The liquid level can either be a digital input (standard) or an analog type input.

The controller can display actual refrigerant level with the analog type (optional). Phase loss, oil failure, and the compressor failure alarms are connected to the rack controller through a digital input. An optional modem can be installed to allow the rack controller to call out any refrigeration alarms.

Alarm Systems

The following alarms are available for use with the parallel rack system:

1. Refrigerant Loss Alarm/Indicator:
An alarm trips if the refrigerant level in the receiver drops below a set level. This alarm automatically compensates for changes in liquid level occurring during heat reclaim.
2. Single Phase Protection: This shuts down the control circuit during single phasing of the power circuit; automatically resets when three phase power is restored.
3. Remote Alarm: In event of a power outage or any alarm condition, an alarm will sound at another location, such as a burglar alarm monitoring station or answering service.

INVERTER CONTROL

An inverter is used to vary the speed of a compressor which in turn varies the capacity of that compressor. With the ability to vary the capacity of a compressor, refrigeration requirements can be better matched to the load.

Unit Cooler Fan Wiring

Provide a 120/1/60 fused power supply for each cooler. (Check the store legend to see if 208-230/1/60 is required at this location.)

Evaporator Mounted Liquid Line Solenoid

Power for a liquid line solenoid in the merchandiser can be picked up from the fan circuit. (Check fan motor and solenoid voltages first.)

Cooler Door Switch Wiring

Check the store legend or electrical plans, for door switch kits. The switch must be mounted to the cooler door frame, and must be wired to control the field-installed liquid line solenoid and evaporator fans. Door switches are wired in series. For Koolgas applications, kit M116 includes a check valve to bypass the liquid line solenoid valve.

Sizing Wire and Overcurrent Protectors

Check the serial plate for Minimum Circuit Ampacity (MCA) and Maximum Overcurrent Protective Devices (MOPD). Follow NEC guidelines.

4-8 ELECTRICAL

NOTES:

START-UP

LEAK TESTING

NOTE:

Leaks harm the ozone layer and can be very expensive. It is very important to follow EPA Greenchill Installation Leak Tightness Guidelines as well as Greenchill Leak Prevention and Repair Guidelines.

CAUTION

Know whether a circuit is open at the power supply or not. Remove all power before opening control panels. Note: Some equipment has more than one power supply.

Check that the compressor's primary ON-OFF switch are all in the OFF position.

NOTE:

Do not start any compressors without ensuring there is oil in them. Serious damage to the compressors may result from not having oil in them. Parallel racks are shipped with the oil loose.

Always use a pressure regulator with a nitrogen tank. Do not exceed two pounds of pressure and vent lines when brazing. Do not exceed 350 pounds of pressure for leak testing high side. Do not exceed 150 pounds of pressure for leak testing low side.

To check for system leaks do the following:

- Leave all valves closed to allow pressure into the rack. Close the suction, liquid or hot gas manifolds. Each rack system is shipped with dry Nitrogen. Build the pressure in the rack unit until it reaches 150 psi. Each individual circuit should be checked.
- Each circuit can be leak checked as the pressure increase to 150 psi. Ensure that

the pressure is the same throughout the assembly. Check connections and accessories for any leaks. Use an electronic leak detector. Inspect all joints. If the pressure drops sharply, this is an indication of a leak. Visually inspect all lines and joints for proper piping practices.

- Once the system has been thoroughly tested, evacuate the system to 1500 microns for the first evacuation.
- The evacuation is repeated. Install liquid and drier cores before the second evacuation. Suction filter cores are factory installed. After each evacuation, the system must be pressurized to 2 psig with dry nitrogen.
- Now evacuate the system to 500 microns for the second evacuation. Perform three evacuations in all.

PRE-CHARGE CHECK LIST

While the system is being evacuated preparation for charging can begin. During any of the pull downs check:

- Merchandiser's electrical requirements and power supply electrical connections are tight and clean
- Check for proper fan operation and thermostat setting.
- Walk-in coolers and freezers electrical requirements and power supply
- Damper operation, if equipped.
- Heat Reclaim and other systems

CHARGING

- Open compressors – backseat service valves on suction and discharge.
- Open oil supply line immediately downstream of the oil separator.
- Pressure transducers – open angle valves. connect defrost time clock and set proper time.
- Leave open ball valves – to branches, condenser, heat reclaim, receiver.
- Main liquid line solenoid valve – now under control of defrost clock.
- Branch liquid line solenoid valve – Back out manual open screws.
- Suction stop EPR – under control of defrost clock.
- Split condenser – operation under pressure controls.

Note:

Remember to reinstate control to unit components jumpered to make test.

Set all mechanical pressure controls. Compressors should still be isolated from the rest of the system. Set all electronic compressor controls into switchback so the mechanical controls are in command of all system functions.

During the last evacuation look up and make a list of the required control settings for the system. A copy of the equipment legend will be needed to determine the system's design operating points. High and low pressure, heat reclaim lockout, winter control settings, and other controls on the system should be noted.

Oil Levels

Check oil levels for each compressor and the Turba-shed or other oil separator:
Compressor sight glass $\frac{1}{8}$ to $\frac{1}{2}$ full, oil separator between two lower sight glasses. See legend for oil types used in parallel rack system.

If the oil is low, add the appropriate oil or lubricant to match the refrigerant used.

Additionally, check for the following during leak test:

Isolate compressors – front seat service valves on suction and discharge. close oil supply line immediately downstream of the oil separator.

Pressure transducers – close angle valves.

Open ball valves – to branches, condenser, heat reclaim, receiver.

Main liquid line solenoid valve - solenoid should be non regulating position.

Branch liquid line solenoid valve - solenoid should be energized or manual open used.

Suction stop EPR valves – suction stop EPR requires energized solenoid to be open.

Split condenser – both sides open.
De-energize valve solenoid.

Defrost time clock – disconnect power to the clock or set electronic controllers in manual. Be sure all branches are in refrigeration mode.

Verify refrigerant requirements for system, Compressors, and TEVs in merchandisers and coolers.

Electrical supply and component requirements.

Always recapture test charge in approved recovery vessel.

Evacuation

Nitrogen and moisture will remain in the system unless proper evacuation procedures are followed. Nitrogen left in the system may cause head pressure problems. Moisture causes TEV ice blockage, wax build up, acid oil and sludge formation.

- Do not simply purge the system. This procedure is expensive, harmful to the environment, and may leave moisture and nitrogen behind.
- Do not run the compressors to evacuate. This procedure introduces moisture into the compressor's crankcase oil and does not produce adequate vacuum to remove moisture from the rest of the system at normal temperatures.

CAUTION

Never trap liquid refrigerant between closed valves as this could cause a hydraulic explosion.

Final Checks

Once the rack is up and running, it is the responsibility of the installer to see that all the fine adjustments are made so the rack delivers maximum temperature performance and efficiency for the customer.

These adjustments include:

- Defrost scheduling and timing
- Condenser controls
- Winter controls
- Sub-cooling Compound System Operation EPR, and ORI settings
- TEV superheat adjustment
- CPR settings High and low pressure controls Main liquid line solenoid differential

Thermostat Settings

Adjustments to electronic controls:

Thoroughly inspect all field piping while the equipment is running and add supports where line vibration occurs. Be sure additional supports do not conflict with pipe expansion and contraction.

When merchandisers are completely stocked, check the operation of the system again. At 48 hours of operation replace the liquid drier and suction filter cores.

At 90 days recheck the entire system, including all field wiring. Change the oil filter. Future maintenance costs may be reduced if an oil acidity test is run at this time. Replace acidic oil.

LIQUID DRIER CORE REPLACEMENT

Replace liquid drier cores 24 hours after initial startup.

After 48 hours of operation, replace the drier cores again. Any time the system is opened after this point, the dryer cores shall be replaced.

SUCTION FILTER CORE REPLACEMENT

Replace suction filter cores 24 hours after initial startup.

After 48 hours of operation, inspect suction filter cores and replace and repeat if they are full of dirt and debris.

NOTES:

 **WARNING**

Intentionally venting or discharging CFC, HFC and HCFC refrigerant violates Federal Law. All CFC, HFC and HCFC refrigerants must be reclaimed and recycled in accordance with all state, federal and local laws.

MAINTENANCE

COMPRESSOR REPLACEMENT

Since each machine room tends to be unique, plan carefully as to how you will move the compressor without harming personnel, equipment or the building. Before beginning removal of an old compressor make replacement unit ready to install:

Verify Replacement compressor electrical requirements, refrigerant, application, capacity, piping hookup location and design suction and discharge gaskets.

Mounting requirements:
Have compressor in an easily accessible position, uncrated and unbolted from shipping pallets.

Disconnect electrical supply:
Turn off motor and control panel power supplies to the Rack. Turn off control circuit and open all compressor circuit breakers. Tag and remove electrical wires and conduit from the compressor.

Isolate compressor from rack:
Front seat suction and discharge service valves. Close oil supply and equalizing lines. Bleed compressor pressure through both discharge and suction access ports into an approved recovery vessel.

Remove oil supply and equalizing lines. Remove externally mounted components which will be re-used on the replacement compressor. Plug holes to compressor manufacturer's specifications.

Remove bolts from suction and discharge service valves.

Remove mounting bolts.
When moving the compressor, use a come-along, hoist or hydraulic lift to carry the weight.

Do not use the rack piping or panel to support a hoist or come-along.

Do not use ceiling trusses to support a hoist or come-along.

The rear support channel on the rack or a properly constructed ceiling rail may be used to support a hoist or come-along.

To make hookup and lifting easier, an eye bolt may be installed in the rear top of the compressor head.

If a compressor removal table is used, slide the compressor fully on to the table, then roll table to overhead hoist or hydraulic lift area.

When the old compressor has been removed, clean the suction and discharge service valve gasket surfaces to shiny metal. Clean the gasket surfaces on the new compressor to shiny metal. Be careful not to groove or round the surfaces. Gasket surfaces must be clean to prevent leaking.

Install the new compressor in reverse order of removal. Do not open the new compressor to the system until after it has been leak tested and triple evacuated.

Note: Oil level regulator sight glasses are designed to provide a hermetic seal when internally pressurized. Some leaking may occur when a deep vacuum is pulled.

Cleaning the Turba-Shed (Oil Separator)

Should the oil separator require cleaning, first shut down the system. Isolate the oil separator and bleed off pressure into an approved recovery vessel. Remove the top and bottom sight glasses and the oil supply line. With a clean, dry, regulated pressure source like nitrogen, blow out any sludge or dirt. Install the sightglasses using new o-rings.

Parker Number 2-23,
Compound 557 Precision Rubber, number 023,
Compound 2337

Leak test, evacuate, and charge with fresh oil refer to legend for oil type. Open valves closed to isolate the oil system and bring the rack back on line.

Replacing Drier and Filter Cores:

Shut down the system. Isolate the core to be replaced and bleed off pressure into an approved recovery vessel. Open housing, replace core and close up. Pressurize, leak test and bring back into line.

WINTER CONDENSING PRESSURE CONTROLS

Five methods are used to control condensing pressure during cold weather operation.

- 1) Flooding valves must be applied to the compressor unit when winter temperatures are expected.
- 2) Temperature Control: Fans are thermostatically controlled and cycled accordingly to outside temperature. Can be applied to single circuited condensers.
- 3) Thermal Fantrol: Used with multi-circuited condensers. Fans are cycled according to outside temperatures.
- 4) Split Condensers (factory or field installed): Used on dual circuit condenser with or without heat reclaim, where a four-way solenoid valve (controlled by ambient sensing temperature control or pressure control) activates to cut off one half of the condensers. Field-installed situations will require double discharge and double condenser leg return piping.

GENERAL MAINTENANCE

Regular inspection and upkeep is critical to operation of the rack. Because of the numerous options and accessories that are unique to each store, it is impossible to list all of the maintenance guidance for individual systems.

Maintenance must be performed by a well qualified technician to diagnose and prevent problems before they may occur. The information below is a general guideline.

Recommended service intervals in your area may vary depending on the operating environment and equipment used. Contact your Hussmann representative for further information.

Generally, the following items should be checked on a weekly basis:

- System Pressures
- Main Power Voltage
- Oil Levels
- Refrigerant Charge

Generally, the following items should be checked on a monthly basis:

- System pressures
- System leak tests
- All filters and drier cores
- Insulation, conduit, electrical boxes and control panels
- Secondary systems, and accessories
- Fan motors, contactors and electrical connections
- Check for tightness of fittings, fan blades and motor mounts

Generally, the following items should be checked on a quarterly basis:

Investigate operating conditions for the following:

- Suction, liquid, and discharge pressures and temperatures
- Sub-cooling, superheat and ambient temperatures
- Safety controls, operating controls and alarms
- Amperage coming from Compressors

Each year, check the following:

- Clean the condenser coil
- Straighten or replace all fan blades
- Change the filter drier and suction cores
- Get an oil sample and determine the quality and change if required

DRIER AND FILTER CORES REPLACEMENT

Replacing Drier and Filter Cores Shut down the system. Isolate the core to be replaced and bleed off pressure into an approved recovery vessel. Open housing, replace core and close up. Pressurize, leak test and bring back into line.

6-4 MAINTENANCE

NOTES:

SERVICE

TROUBLE SHOOTING INFORMATION

SPORLAN

<http://www.sporlanonline.com>

EMERSON

Fault Finder app

<http://www.emersonclimate.com/en-us/>
[Resources/Mobile Apps/Pages/mobileapps.aspx](http://www.emersonclimate.com/en-us/)

SQUARE D HOTLINE

888-SQUARED (888-778-2733)

Tech Support Line. Level One provides product initial Tech Support and can connect the Caller to Level 2, if required.

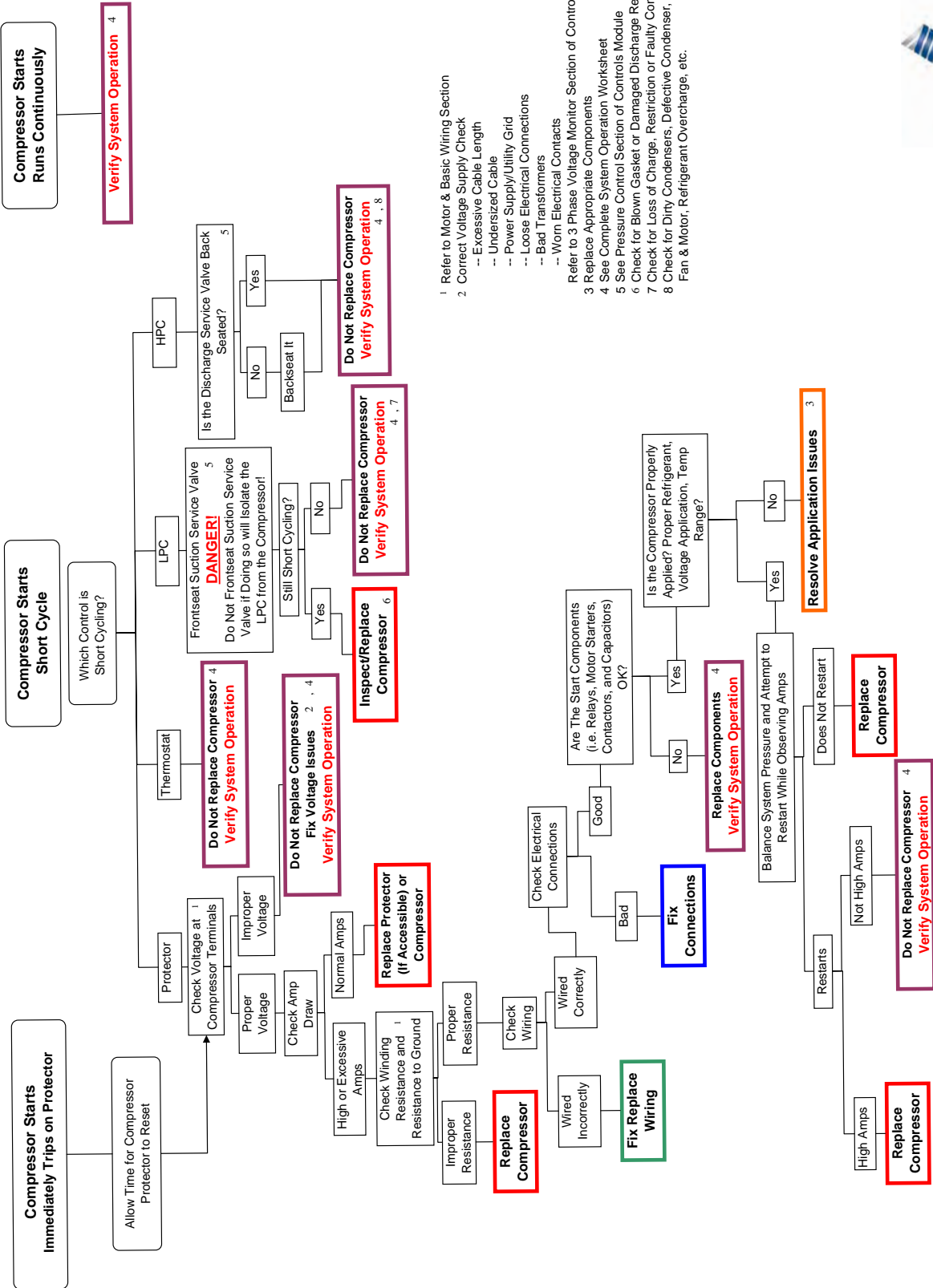

- 1 Refer to Motor & Basic Wiring Section
- 2 Correct Voltage Supply Check
 - Excessive Cable Length
 - Undersized Cable
 - Power Supply/Utility Grid
 - Loose Electrical Connections
 - Bad Transformers
 - Worn Electrical Contacts
- 3 Refer to 3 Phase Voltage Monitor Section of Controls Module
- 4 Replace Appropriate Components
- 5 See Complete System Operation Worksheet
- 6 Check for Blown Gasket or Damaged Discharge Needs
- 7 Check for Loss of Charge, Restriction or Faulty Control
- 8 Check for Dirty Condensers, Defective Condenser, Fan & Motor, Refrigerant Overcharge, etc.





Trouble Shooting Guide

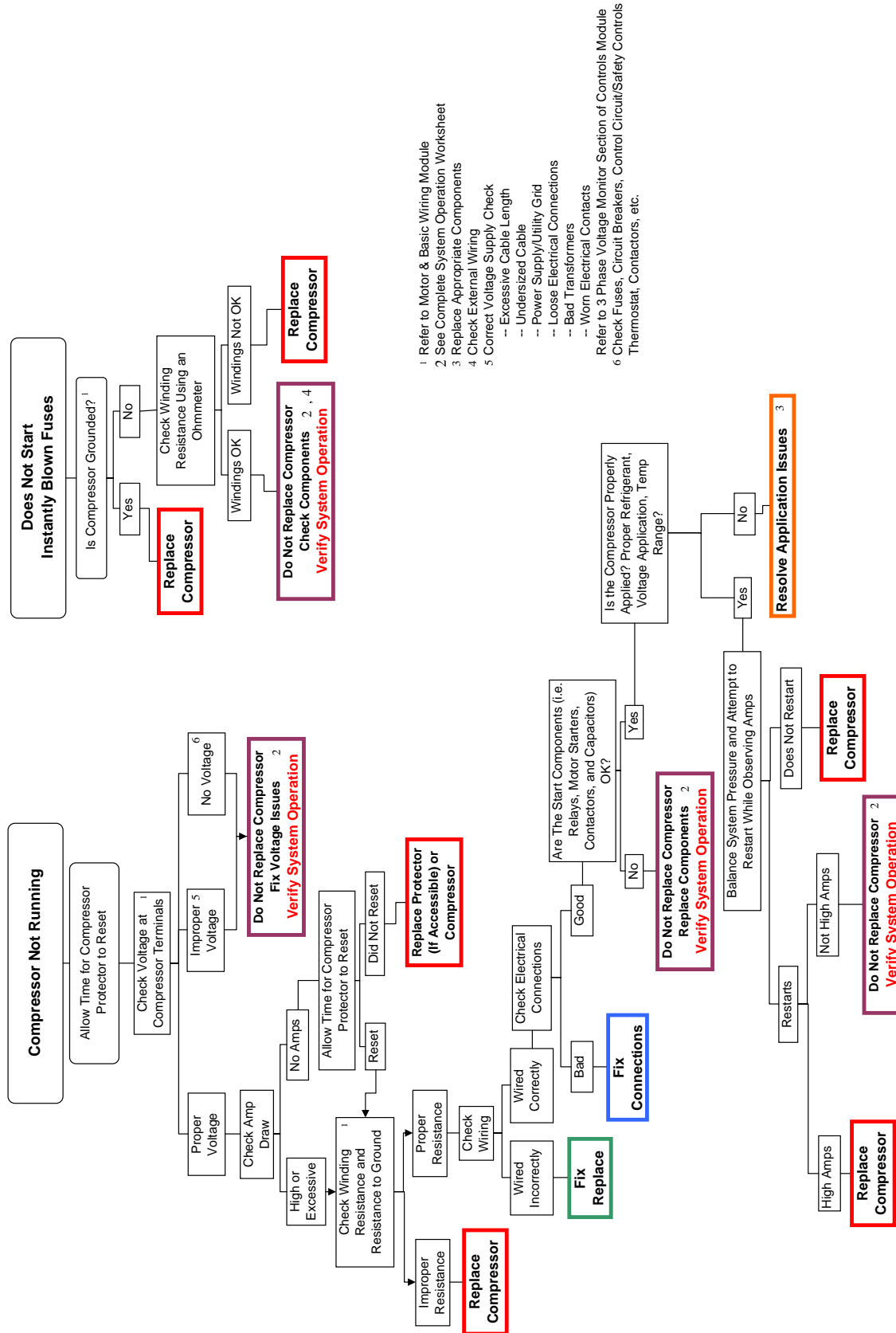

Form No. 2004CC-126
© 2004 Copeland Corporation



SUPERMARKET EQUIPMENT
PRODUCT INFORMATION

 THERMOSTATIC EXPANSION VALVES

 REFRIGERANT DISTRIBUTORS

 SOLENOID VALVES XSP SERIES

 GLYCOL SOLENOID VALVES

 SOLENOID VALVES

 CATCH-ALL FILTER-DRIERS

 HEAD PRESSURE CONTROL VALVES

 EVAPORATOR PRESSURE REGULATING VALVES

 DEFROST DIFFERENTIAL VALVE

 ELECTRIC VALVES SER SERIES

 ELECTRIC VALVES CDS SERIES

 PRESSURE TRANSDUCERS & TEMPERATURE SENSORS

 KELVIN II SERIES

 PSK CONTROLLERS MODEL 214

Form 5-422



Additional Sporlan Resources
SPORLAN APPS
SPORLAN SELECTION PROGRAM

www.sporlanonline.com





HUSSMANN[®]

**To obtain warranty information
or other support, contact your
Hussmann representative.
Please include the model and
serial number of the product.**

Hussmann Corporation, Corporate Headquarters: Bridgeton, Missouri, U.S.A. 63044-2483 01 October 2012