

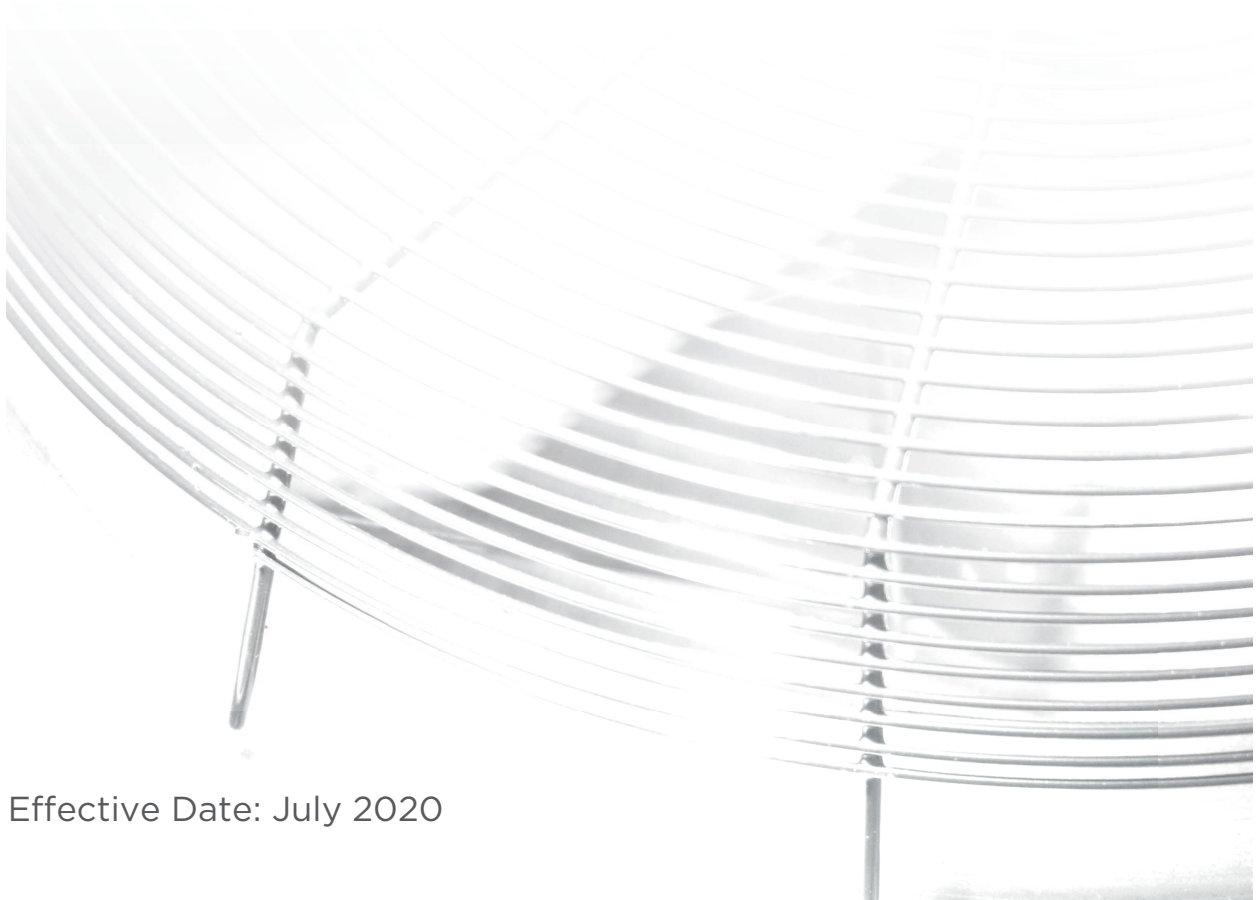

Commercial Refrigeration Price List

KPL6_010_070220



Effective Date: July 2020

Krack Commercial Refrigeration Price Lists are updated quarterly;
January, April, July and October; and posted on our website at www.krack.com.

Products that provide lasting solutions.

CHANGES SINCE THE LAST PRICE LIST:

- Formatting and notes updated on all evaporators.
- Added new evaporator control options for 24V relay and stand alone variable speed control.

Krack, a Hussmann Corporation brand
1049 Lily Cache Lane, Suite A
Bolingbrook, Illinois 60440
Phone: 630.629.7500

Website: www.krack.com

*Krack Price Lists are updated periodically with updates posted on our website at www.krack.com.
Please contact Erik Haffner (erik.haffner@hussmann.com) with questions or comments.*

LH PRODUCT DESCRIPTION - LOW HEIGHT CENTER MOUNT EVAPORATORS

Version: **July 2020**

LH MODEL KEY

LH	D	2	6	E	-	129	T	D	A	A								
Unit Type LH - Low Height								Heater Voltage A - 208-230/1/60										
DOE Application D - DOE and NRCan A - Non-Regulated								Motor Voltage A - 208-230/1/60 B - 115/1/60										
Number of Fans		2 6						Motor Type D - Two Speed EC V - Variable Speed EC B - PSC Motors**										
Fin Spacing 4, 6 FPI								Refrigerant										
Type of Defrost A - Air Defrost E - Electric Defrost with Electric Pan Heat								<table border="0"> <tr> <td>N - Non-Glide</td> <td>G - Glide Refrigerants</td> </tr> <tr> <td>S - R-404A</td> <td>Q - R-407A T - R-448A</td> </tr> <tr> <td>P - R-507A</td> <td>F - R-407F R - R-449A</td> </tr> <tr> <td colspan="2">B - Glycol</td> </tr> </table>			N - Non-Glide	G - Glide Refrigerants	S - R-404A	Q - R-407A T - R-448A	P - R-507A	F - R-407F R - R-449A	B - Glycol	
N - Non-Glide	G - Glide Refrigerants																	
S - R-404A	Q - R-407A T - R-448A																	
P - R-507A	F - R-407F R - R-449A																	
B - Glycol																		
BTU/h in Hundreds (00)																		

** PSC motors are not allowed for DOE/NRCan regulated applications.

DOE/NRCan applications will require two speed or variable speed fans.



Prices, product availability, and specifications are subject to change without notice.



LH PRODUCT DESCRIPTION - LOW HEIGHT CENTER MOUNT EVAPORATORS

Version: **July 2020**

AIR DEFROST - MEDIUM TEMPERATURE - LOW HEIGHT

MODEL	LIST PRICE	CAPACITY (BTUH) @ 10° F TD	AIR FLOW (CFM)	DIMENSIONS (IN)			SHIP WGT (LBS)
				L	W	H	
LHD16A-047[]D	\$1,740	4,700	650	32.875	26.063	9.25	42
LHD26A-094[]D	\$2,720	9,400	1,300	54.875	26.063	9.25	70
LHD36A-140[]D	\$3,760	14,000	1,950	76.875	26.063	9.25	123
LHD46A-187[]D	\$4,720	18,700	2,600	98.875	26.063	9.25	164
LHD14A-036[]D	\$1,670	3,600	683	32.875	26.063	9.25	38
LHD24A-073[]D	\$2,510	7,300	1,365	54.875	26.063	9.25	64
LHD34A-109[]D	\$3,230	10,900	2,048	76.875	26.063	9.25	105
LHD44A-145[]D	\$4,410	14,500	2,730	98.875	26.063	9.25	146

* See technical bulletin for use of D for DOE/NRCan compliant model or A for non-regulated.
Two speed EC motors are standard; deduct for PSC "B" or add for Variable Speed EC "V" motors.
[] Refrigerant letter. Include price adder for circuiting with B - glycol and C - CO₂.

ELECTRIC DEFROST- LOW / MEDIUM TEMPERATURE- LOW HEIGHT

MODEL	LIST PRICE	CAPACITY (BTUH) @ 10° TD		AIR FLOW (CFM)	DIMENSIONS (IN)			SHIP WGT (LBS)
		-20° F Evap	+20° F Evap		L	W	H	
LHD16E-043[]D	\$2,260	4,300	4,700	650	32.875	26.063	9.25	44
LHD26E-086[]D	\$3,340	8,600	9,400	1,300	54.875	26.063	9.25	73
LHD36E-129[]D	\$4,250	12,900	14,000	1,950	76.875	26.063	9.25	127
LHD46E-171[]D	\$5,280	17,100	18,700	2,600	98.875	26.063	9.25	169
LHD14E-033[]D	\$2,110	3,300	3,600	683	32.875	26.063	9.25	40
LHD24E-067[]D	\$3,120	6,700	7,300	1,365	54.875	26.063	9.25	67
LHD34E-100[]D	\$4,140	10,000	10,900	2,048	76.875	26.063	9.25	109
LHD44E-132[]D	\$4,750	13,200	14,500	2,730	98.875	26.063	9.25	150

* See technical bulletin for use of D for DOE/NRCan compliant model or A for non-regulated.
Two speed EC motors are standard; deduct for PSC "B" or add for Variable Speed EC "V" motors.
[] Refrigerant letter. Include price adder for circuiting with B - glycol and C - CO₂.

LH MODEL OPTIONS

No. of Fans	Variable Speed EC Motor Adder*	PSC Motor Deduct*	Painted Housing white/ black	SS Housing & Non Insulated Drain Pan	SS Non Insulated Drain Pan (only)	Electro Fin (Air Defrost only)	Copper Fin	Circuiting CO ₂
1	\$20	(\$10)	\$510	\$1,120	\$350	\$1,460	\$370	\$280
2	\$40	(\$20)	\$510	\$1,570	\$430	\$1,460	\$740	\$280
3	\$60	(\$30)	\$620	\$2,090	\$560	\$1,460	\$1,110	\$280
4	\$80	(\$40)	\$690	\$2,530	\$620	\$1,460	\$1,480	\$280

Insulated or stainless steel drain pan are NOT available on LH due to drain fitting and forming requirements.

- DOE/NRCan models are shown and can be applied for non-regulated applications without controls.
- Confirm AWEF for refrigerant being applied and select variable speed motor if required.
- Controls for two speed or variable speed are not included in unit pricing shown.
- Select from controls options on Unit Cooler Accessories.
- Capacities shown reflect midpoint evaporating temperature.

Prices, product availability, and specifications are subject to change without notice.



**GH / GL PRODUCT DESCRIPTION -
LOW VELOCITY CENTER MOUNT MODELS**

Version: **July 2020**

GH / GL MODEL KEY

GL	D	3	6	D	-	135	T	D	A	K	
Unit Type GH & GL: Gentle Air				Heater Type A - 208-230/1/60 B - 115/1/60* K - 208-230/3/60				Motor Voltage A - 208-230/1/60 B - 115/1/60			
DOE Application D - DOE and NRCan A - Non-Regulated				Motor Voltage D - Two Speed EC V - Variable Speed EC B - PSC Motors**				Refrigerant			
Number of Fans				BTU/h in Hundreds (00)				N - Non-Glide S - R-404A P - R-507A		G - Glide Refrigerants Q - R-407A T - R-448A F - R-407F R - R-449A	
Fin Spacing 4, 6 FPI											
Type of Defrost A - Air Defrost D - Electric Defrost w/ No Pan Heat F - 3 Pipe Hot Gas w/ No Pan Heat H - 3 Pipe Hot Gas w/ Electric Pan Heat M - 2 Pipe Kool Gas w/ No Pan Heat P - 2 Pipe Kool Gas w/ Electric Pan Heat											

* Available on pan heaters for H and P defrost options only.

** PSC motors are not allowed for DOE/NRCan regulated applications.



DOE/NRCan applications will require two speed or variable speed fans.

Prices, product availability, and specifications are subject to change without notice.



GH / GL PRODUCT DESCRIPTION - LOW VELOCITY CENTER MOUNT MODELS

Version: July 2020

AIR DEFROST - MEDIUM TEMPERATURE - LOW VELOCITY

GENTLE AIR - 18" LOW SILHOUETTE

MODEL	LIST PRICE	CAPACITY (BTUH) @ 10° F TD	AIR FLOW (CFM)	DIMENSIONS (IN)			SHIP WGT (LBS)
				L	W	H	
GH*16A-060[]D	\$2,710	6,000	900	31.75	28.75	18.25	130
GH*26A-130[]D	\$4,250	13,000	1,800	49.75	28.75	18.25	180
GH*36A-198[]D	\$6,040	19,800	2,700	67.75	28.75	18.25	240
GH*46A-270[]D	\$7,320	27,000	3,600	85.75	28.75	18.25	320
GH*56A-340[]D	\$8,670	34,000	4,500	103.75	28.75	18.25	370
GH*66A-410[]D	\$10,030	41,000	5,400	121.75	28.75	18.25	420
GH*14A-050[]D	\$2,550	5,000	940	31.75	28.75	18.25	120
GH*24A-100[]D	\$4,180	10,000	1,880	49.75	28.75	18.25	170
GH*34A-150[]D	\$5,930	15,000	2,820	67.75	28.75	18.25	230
GH*44A-200[]D	\$7,200	20,000	3,760	85.75	28.75	18.25	310
GH*54A-250[]D	\$8,590	25,000	4,700	103.75	28.75	18.25	360
GH*64A-300[]D	\$9,930	30,000	5,640	121.75	28.75	18.25	410

GENTLE AIR - 12" LOW SILHOUETTE

MODEL	LIST PRICE	CAPACITY (BTUH) @ 10° F TD	AIR FLOW (CFM)	DIMENSIONS (IN)			SHIP WGT (LBS)
				L	W	H	
GL*16A-045[]D	\$2,330	4,500	600	31.75	28.75	12.25	100
GL*26A-090[]D	\$3,660	9,000	1,200	49.75	28.75	12.25	140
GL*36A-135[]D	\$4,940	13,500	1,800	67.75	28.75	12.25	190
GL*46A-180[]D	\$6,380	18,000	2,400	85.75	28.75	12.25	250
GL*56A-225[]D	\$7,390	22,500	3,000	103.75	28.75	12.25	290
GL*66A-268[]D	\$8,170	26,800	3,600	121.75	28.75	12.25	340
GL*14A-035[]D	\$2,320	3,500	630	31.75	28.75	12.25	90
GL*24A-070[]D	\$3,620	7,000	1,260	49.75	28.75	12.25	130
GL*34A-105[]D	\$4,890	10,500	1,890	67.75	28.75	12.25	180
GL*44A-140[]D	\$6,320	14,000	2,520	85.75	28.75	12.25	240
GL*54A-175[]D	\$7,310	17,500	3,150	103.75	28.75	12.25	280
GL*64A-210[]D	\$7,950	21,000	3,780	121.75	28.75	12.25	330

* See technical bulletin for use of D for DOE/NRCan compliant model or A for non-regulated.

Two speed EC motors are standard; deduct for PSC "B" or add for Variable Speed EC "V" motors.

[] Refrigerant letter. Include price adder for circuiting with B - glycol and C - CO₂.

GH / GL MODEL OPTIONS

No. of Fans	Variable Speed EC Motor Adder*	PSC Motor Deduct*	Reverse Air Flow Direction	Copper Fin	Electro Fin (Air or Gas Defrost only)	Circuiting- Glycol or CO ₂
1	\$20	(\$10)	\$90	\$510	\$2,430	\$280
2	\$40	(\$20)	\$180	\$1,020	\$2,430	\$280
3	\$60	(\$30)	\$270	\$1,530	\$2,430	\$280
4	\$80	(\$40)	\$360	\$2,040	\$2,430	\$280
5	\$100	(\$50)	\$450	\$2,550	\$2,430	\$280
6	\$120	(\$60)	\$540	\$3,060	\$2,570	\$280

No. of Fans	Insulated Aluminum Drain Pan	SS Housing & AL Ins Pan	SS Housing & SS Non Ins Drain Pan	SS Drain Pan**	Painted Housing White/Black	Air Filters, Wire Fan Guard
1	\$470	\$2,580	\$1,560	\$560	\$510	\$70
2	\$530	\$3,230	\$2,040	\$680	\$510	\$140
3	\$610	\$3,780	\$2,560	\$840	\$620	\$210
4	\$710	\$4,610	\$3,080	\$990	\$690	\$280
5	\$900	\$6,050	\$3,910	\$1,420	\$820	\$350
6	\$1,300	\$6,720	\$4,390	\$1,570	\$1,000	\$420

** SS Drain Pan is not available insulated due to difficulty forming stainless steel.

- DOE/NRCan models are shown and can be applied for non-regulated applications without controls.
- Confirm AWEF for refrigerant being applied and select variable speed motor if required.
- Controls for two speed or variable speed are not included in unit pricing shown.
- Select from controls options on Unit Cooler Accessories.
- Capacities shown reflect midpoint evaporating temperature.



**GH / GL PRODUCT DESCRIPTION -
LOW VELOCITY CENTER MOUNT MODELS**

Version: **July 2020**

ELECTRIC DEFROST - MEDIUM TEMPERATURE - LOW VELOCITY

GENTLE AIR - 18" LOW SILHOUETTE

MODEL	LIST PRICE	CAPACITY (BTUH) @ 10° F TD	AIR FLOW (CFM)	DIMENSIONS (IN)			SHIP WGT (LBS)
				L	W	H	
GH*16D-060[]D	\$2,970	6,000	900	31.75	28.75	18.25	130
GH*26D-130[]D	\$4,870	13,000	1,800	49.75	28.75	18.25	180
GH*36D-198[]D	\$6,830	19,800	2,700	67.75	28.75	18.25	240
GH*46D-270[]D	\$8,140	27,000	3,600	85.75	28.75	18.25	320
GH*56D-340[]D	\$9,650	34,000	4,500	103.75	28.75	18.25	370
GH*66D-410[]D	\$11,140	41,000	5,400	121.75	28.75	18.25	420
GH*14D-050[]D	\$2,860	5,000	940	31.75	28.75	18.25	120
GH*24D-100[]D	\$4,740	10,000	1,880	49.75	28.75	18.25	170
GH*34D-150[]D	\$6,640	15,000	2,820	67.75	28.75	18.25	230
GH*44D-200[]D	\$8,020	20,000	3,760	85.75	28.75	18.25	310
GH*54D-250[]D	\$9,530	25,000	4,700	103.75	28.75	18.25	360
GH*64D-300[]D	\$11,020	30,000	5,640	121.75	28.75	18.25	410

GENTLE AIR - 12" LOW SILHOUETTE

MODEL	LIST PRICE	CAPACITY (BTUH) @ 10° F TD	AIR FLOW (CFM)	DIMENSIONS (IN)			SHIP WGT (LBS)
				L	W	H	
GL*16D-045[]D	\$2,580	4,500	600	31.75	28.75	12.25	100
GL*26D-090[]D	\$4,070	9,000	1,200	49.75	28.75	12.25	140
GL*36D-135[]D	\$5,470	13,500	1,800	67.75	28.75	12.25	190
GL*46D-180[]D	\$7,080	18,000	2,400	85.75	28.75	12.25	250
GL*56D-225[]D	\$8,200	22,500	3,000	103.75	28.75	12.25	290
GL*66D-268[]D	\$9,320	26,800	3,600	121.75	28.75	12.25	340
GL*14D-035[]D	\$2,430	3,500	630	31.75	28.75	12.25	90
GL*24D-070[]D	\$3,880	7,000	1,260	49.75	28.75	12.25	130
GL*34D-105[]D	\$5,230	10,500	1,890	67.75	28.75	12.25	180
GL*44D-140[]D	\$6,770	14,000	2,520	85.75	28.75	12.25	240
GL*54D-175[]D	\$7,820	17,500	3,150	103.75	28.75	12.25	280
GL*64D-210[]D	\$8,910	21,000	3,780	121.75	28.75	12.25	330

* See technical bulletin for use of D for DOE/NRCan compliant model or A for non-regulated.

Two speed EC motors are standard; deduct for PSC "B" or add for Variable Speed EC "V" motors.

[] Refrigerant letter. Include price adder for circuiting with B - glycol and C - CO₂.

NOTE: Not For Use Below +20° F Room Temperature

- Models shown can be applied for non-regulated applications without controls.
- Confirm AWEF for refrigerant being applied and select variable speed motor if required.
- Controls for two speed or variable speed are not included in unit pricing shown.
- Select from controls options on Unit Cooler Accessories.
- Capacities shown reflect midpoint evaporating temperature.

Prices, product availability, and specifications are subject to change without notice.



**GH / GL PRODUCT DESCRIPTION -
LOW VELOCITY CENTER MOUNT MODELS**

Version: **July 2020**

GAS DEFROST - MEDIUM TEMPERATURE - LOW VELOCITY

GENTLE AIR - 18" HIGH SILHOUETTE

MODEL	LIST PRICE BY DEFROST TYPE				CAPACITY (BTUH) @ 10° F TD	AIR FLOW (CFM)	DIMENSIONS (IN)			SHIP WGT (LBS)
	(P)	(M)	(H)	(F)			L	W	H	
GH*16()-060[]D	\$3,190	\$2,890	\$2,950	\$2,720	6,000	900	31.75	28.75	18.25	130
GH*26()-130[]D	\$5,060	\$4,700	\$4,840	\$4,450	13,000	1,800	49.75	28.75	18.25	180
GH*36()-198[]D	\$6,960	\$6,440	\$6,700	\$6,200	19,800	2,700	67.75	28.75	18.25	240
GH*46()-270[]D	\$8,340	\$7,740	\$8,090	\$7,490	27,000	3,600	85.75	28.75	18.25	320
GH*56()-340[]D	\$9,830	\$9,130	\$9,570	\$8,880	34,000	4,500	103.75	28.75	18.25	370
GH*66()-410[]D	\$11,300	\$10,500	\$11,060	\$10,250	41,000	5,400	121.75	28.75	18.25	420
GH*14()-050[]D	\$3,090	\$2,870	\$2,850	\$2,630	5,000	940	31.75	28.75	18.25	120
GH*24()-100[]D	\$4,950	\$4,610	\$4,700	\$4,360	10,000	1,880	49.75	28.75	18.25	170
GH*34()-150[]D	\$6,820	\$6,350	\$6,570	\$6,090	15,000	2,820	67.75	28.75	18.25	230
GH*44()-200[]D	\$8,220	\$7,620	\$7,970	\$7,370	20,000	3,760	85.75	28.75	18.25	310
GH*54()-250[]D	\$9,570	\$9,020	\$9,460	\$8,760	25,500	4,700	103.75	28.75	18.25	360
GH*64()-300[]D	\$11,200	\$10,410	\$10,940	\$10,160	30,000	5,640	121.75	28.75	18.25	410

GENTLE AIR - 12" LOW SILHOUETTE

MODEL	LIST PRICE BY DEFROST TYPE				CAPACITY (BTUH) @ 10° F TD	AIR FLOW (CFM)	DIMENSIONS (IN)			SHIP WGT (LBS)
	(P)	(M)	(H)	(F)			L	W	H	
GL*16()-045[]D	\$2,760	\$2,570	\$2,520	\$2,330	4,500	600	31.75	28.75	12.25	100
GL*26()-090[]D	\$4,230	\$3,950	\$3,980	\$3,690	9,000	1,200	49.75	28.75	12.25	140
GL*36()-135[]D	\$5,610	\$5,220	\$5,360	\$4,970	13,500	1,800	67.75	28.75	12.25	190
GL*46()-180[]D	\$7,170	\$6,690	\$6,930	\$6,440	18,000	2,300	85.75	28.75	12.25	250
GL*56()-225[]D	\$8,260	\$7,690	\$8,010	\$7,440	22,500	3,000	103.75	28.75	12.25	290
GL*66()-268[]D	\$9,350	\$8,730	\$9,110	\$8,490	26,800	3,600	121.75	28.75	12.25	340
GL*14()-035[]D	\$2,710	\$2,510	\$2,460	\$2,270	3,500	630	31.75	28.75	12.25	90
GL*24()-070[]D	\$4,180	\$3,880	\$3,980	\$3,640	7,000	1,260	49.75	28.75	12.25	130
GL*34()-105[]D	\$5,540	\$5,170	\$5,360	\$4,920	10,500	1,890	67.75	28.75	12.25	180
GL*44()-140[]D	\$7,100	\$6,620	\$6,850	\$6,360	14,000	2,520	85.75	28.75	12.25	240
GL*54()-175[]D	\$8,180	\$7,630	\$7,920	\$7,380	17,500	3,150	103.75	28.75	12.25	280
GL*64()-210[]D	\$9,260	\$8,650	\$9,010	\$8,400	21,000	3,780	121.75	28.75	12.25	330

* See technical bulletin for use of D for DOE/NRC compliant model or A for non-regulated.

Two speed EC motors are standard; deduct for PSC "B" or add for Variable Speed EC "V" motors.

[] Refrigerant letter. Include price adder for circuiting with B - glycol and C - CO₂.

Available Defrost of Types

(H) = HGE 3 Pipe Hot Gas with Electric Pan Heat - No defrost termination or fan delay, +20° F or warmer room temperature.

(F) = HG 3 Pipe Hot Gas with No Pan Heat - No defrost termination or fan delay, +32° F or warmer room temperature.

(P) = KGE 2 Pipe Kool Gas with Electric Pan Heat, +20° F or warmer room temperature.

(M) = KG 2 Pipe Kool Gas with No Pan Heat, +32° F or warmer room temperature.

- Models shown can be applied for non-regulated applications without controls.
- Confirm AWEF for refrigerant being applied and select variable speed motor if required.
- Controls for two speed or variable speed are not included in unit pricing shown.
- Select from controls options on Unit Cooler Accessories.
- Capacities shown reflect midpoint evaporating temperature.

Prices, product availability, and specifications are subject to change without notice.



KR PRODUCT DESCRIPTION - COMPACT SERIES LOW PROFILE EVAPORATORS

Version: **July 2020**

KR MODEL KEY

KR	D	2	6	A	-	125	T	D	A	A
Unit Type KR - Compact Series										Heater Voltage A - 208-230/1/60 B - 115/1/60* K - 208-230/3/60
DOE Application D - DOE and NRCan A - Non-Regulated										Motor Voltage A - 208-230/1/60 B - 115/1/60
Number of Fans										Motor Type D - Two Speed EC V - Variable Speed EC B - PSC Motors**
Fin Spacing 4, 6 FPI										Refrigerant N - Non-Glide S - R-404A P - R-507A B - Glycol G - Glide Refrigerants Q - R-407A T - R-448A F - R-407F R - R-449A
Type of Defrost A - Air Defrost E - Electric Defrost with Electric Pan Heat G - 3 Pipe Hot Gas with Gas Pan Heat H - 3 Pipe Hot Gas with Electric Pan Heat K - 2 Pipe Kool Gas with Gas Pan Heat P - 2 Pipe Kool Gas with Electric Pan Heat R - Heat Reclaim										BTU/h in Hundreds (00)

* Available on pan heaters for H and P defrost options only.

** PSC motors are not allowed for DOE/NRCan regulated applications.



DOE/NRCan applications will require two speed or variable speed fans.

Prices, product availability, and specifications are subject to change without notice.



KR PRODUCT DESCRIPTION - COMPACT SERIES LOW PROFILE EVAPORATORS

Version: **July 2020**

AIR DEFROST - MEDIUM TEMPERATURE

MODEL	LIST PRICE	CAPACITY (BTUH) @ 10°F TD	AIR FLOW (CFM)	DIMENSIONS (IN)			SHIP WGT (LBS)
		+25 Evap		L	W	H	
KR*16A-040[]D	\$1,250	4,000	845	29.13	15.32	15.9	55
KR*16A-060[]D	\$1,410	6,000	845	29.13	15.32	15.9	60
KR*26A-089[]D	\$2,160	8,900	1,690	47.13	15.32	15.9	100
KR*26A-125[]D	\$2,510	12,500	1,690	47.13	15.32	15.9	100
KR*36A-134[]D	\$2,970	13,400	2,535	65.13	15.32	15.9	120
KR*36A-170[]D	\$3,530	17,000	2,535	65.13	15.32	15.9	140
KR*46A-216[]D	\$4,420	21,600	3,380	83.13	15.32	15.9	180
KR*56A-242[]D	\$5,100	24,200	4,225	101.13	15.32	15.9	220
KR*66A-340[]D	\$6,510	34,000	5,070	119.13	15.32	15.9	265
KR*14A-058[]D	\$1,290	5,800	855	29.13	15.32	15.9	60
KR*24A-096[]D	\$2,300	9,600	1,750	47.13	15.32	15.9	90
KR*24A-117[]D	\$2,430	11,700	1,710	47.13	15.32	15.9	100
KR*34A-143[]D	\$2,950	14,300	2,625	65.13	15.32	15.9	125
KR*34A-173[]D	\$3,450	17,300	2,565	65.13	15.32	15.9	140
KR*44A-191[]D	\$4,170	19,100	3,500	83.13	15.32	15.9	165
KR*44A-232[]D	\$4,440	23,200	3,420	83.13	15.32	15.9	180
KR*54A-290[]D	\$5,450	29,000	4,275	101.13	15.32	15.9	225
KR*64A-348[]D	\$6,460	34,800	5,130	119.13	15.32	15.9	265

* See technical bulletin for use of D for DOE/NRCan compliant model or A for non-regulated.

Two speed EC motors are standard; deduct for PSC "B" or add for Variable Speed EC "V" motors.

[] Refrigerant letter. Include price adder for circuiting with B - glycol and C - CO₂.

KR MODEL OPTIONS

No. of Fans	Variable Speed EC Motor Adder*	PSC Motor Deduct*	Reverse Air Flow Direction	Electro Fin (Air or Gas Defrost only)	Copper Fins	Painted Housing White/Black	Circuiting-Glycol or CO ₂
1	\$20	(\$10)	\$90	\$1,480	\$370	\$310	\$280
2	\$40	(\$20)	\$180	\$1,480	\$740	\$310	\$280
3	\$60	(\$30)	\$270	\$1,480	\$1,110	\$440	\$280
4	\$80	(\$40)	\$360	\$1,480	\$1,480	\$440	\$280
5	\$100	(\$50)	\$450	\$1,480	\$1,850	\$440	\$280
6	\$120	(\$60)	\$540	\$1,760	\$2,220	\$510	\$280

No. of Fans	Long Throw Adapters	Insulated Aluminum Drain Pan	SS Long Throw Adapters	SS Drain Pan (only)	SS Housing & SS Drain Pan**		
1	\$80	\$470	\$370	\$330	\$870		
2	\$160	\$590	\$740	\$510	\$1,210		
3	\$240	\$720	\$1,110	\$580	\$1,360		
4	\$320	\$860	\$1,480	\$690	\$1,650		
5	\$400	\$1,000	\$1,850	\$740	\$1,980		
6	\$480	\$1,140	\$2,220	\$760	\$2,260		

** Standard drain pan in stainless steel. Insulated drain pan is aluminum only.

- DOE/NRCan models are shown and can be applied for non-regulated applications without controls.
- Confirm AWEF for refrigerant being applied and select variable speed motor if required.
- Controls for two speed or variable speed are not included in unit pricing shown.
- Select from controls options on Unit Cooler Accessories.
- Capacities shown reflect midpoint evaporating temperature.



**KR PRODUCT DESCRIPTION -
COMPACT SERIES LOW PROFILE EVAPORATORS**

Version: **July 2020**

ELECTRIC DEFROST - LOW / MEDIUM TEMPERATURE

MODEL	LIST PRICE	CAPACITY (BTUH) @ 10°F TD		AIR FLOW (CFM)	DIMENSIONS (IN)			SHIP WGT (LBS)
		-20° F	+20° F		L	W	H	
KR*14E-037[]D	\$1,580	3,700	5,000	875	29.13	15.32	15.9	55
KR*24E-074[]D	\$2,930	7,400	9,990	1,750	47.13	15.32	15.9	90
KR*34E-111[]D	\$4,080	11,100	14,990	2,625	65.13	15.32	15.9	125
KR*44E-148[]D	\$5,400	14,800	19,850	3,500	83.13	15.32	15.9	165
KR*54E-185[]D	\$6,800	18,500	24,980	4,375	101.13	15.32	15.9	200
KR*64E-220[]D	\$7,770	22,000	29,700	5,250	119.13	15.32	15.9	240
KR*16E-035[]D	\$1,790	3,500	4,730	845	29.13	15.32	15.9	55
KR*16E-045[]D	\$1,980	4,500	6,080	845	29.13	15.32	15.9	60
KR*26E-090[]D	\$2,960	9,000	12,150	1,690	47.13	15.32	15.9	100
KR*36E-135[]D	\$4,220	13,500	18,230	2,535	65.13	15.32	15.9	140
KR*46E-180[]D	\$5,650	18,000	24,300	3,380	83.13	15.32	15.9	180
KR*56E-192[]D	\$6,310	19,200	25,920	4,225	101.13	15.32	15.9	220
KR*66E-270[]D	\$8,070	27,000	36,450	5,070	119.13	15.32	15.9	265

* See technical bulletin for use of D for DOE/NRCan compliant model or A for non-regulated.

Two speed EC motors are standard; deduct for PSC "B" or add for Variable Speed EC "V" motors.

[] Refrigerant letter. Include price adder for circuiting with B - glycol and C - CO₂.

- DOE/NRCan models are shown and can be applied for non-regulated applications without controls.
- Confirm AWEF for refrigerant being applied and select variable speed motor if required.
- Controls for two speed or variable speed are not included in unit pricing shown.
- Select from controls options on Unit Cooler Accessories.
- Capacities shown reflect midpoint evaporating temperature.

Prices, product availability, and specifications are subject to change without notice.



KR PRODUCT DESCRIPTION - COMPACT SERIES LOW PROFILE EVAPORATORS

Version: July 2020

GAS DEFROST - LOW / MEDIUM TEMPERATURE

MODEL	LIST PRICE BY DEFROST TYPE				CAPACITY (BTUH) @ 10°F TD		AIR FLOW (CFM)	DIMENSIONS (IN)			SHIP WGT (LBS)
	(P)	(K)	(H)	(G)	-20° F	+20° F		L	W	H	
KR*14()-037[]D	\$1,710	\$2,190	\$1,590	\$1,990	3,700	5,000	875	29.13	15.32	15.9	55
KR*24()-074[]D	\$3,060	\$3,920	\$2,860	\$3,580	7,400	9,990	1,750	47.13	15.32	15.9	90
KR*34()-111[]D	\$3,460	\$4,360	\$3,260	\$3,990	11,100	14,990	2,625	65.13	15.32	15.9	125
KR*44()-148[]D	\$4,510	\$5,680	\$4,250	\$5,210	14,800	19,850	3,500	83.13	15.32	15.9	165
KR*54()-185[]D	\$5,580	\$7,020	\$5,260	\$6,450	18,500	24,980	4,375	101.13	15.32	15.9	200
KR*64()-220[]D	\$6,540	\$8,220	\$6,170	\$7,550	22,000	29,700	5,250	119.13	15.32	15.9	240
KR*16()-035[]D	\$1,790	\$2,300	\$1,660	\$2,090	3,500	4,730	845	29.13	15.32	15.9	55
KR*16()-045[]D	\$2,080	\$2,700	\$1,930	\$2,450	4,500	6,080	845	29.13	15.32	15.9	60
KR*26()-090[]D	\$3,190	\$4,100	\$3,000	\$3,740	9,000	12,150	1,690	47.13	15.32	15.9	100
KR*36()-135[]D	\$3,700	\$4,680	\$3,470	\$4,270	13,500	18,230	2,535	65.13	15.32	15.9	140
KR*46()-180[]D	\$4,770	\$6,020	\$4,480	\$5,510	18,000	24,300	3,380	83.13	15.32	15.9	180
KR*56()-192[]D	\$5,500	\$6,750	\$5,220	\$6,240	19,200	25,920	4,225	101.13	15.32	15.9	220
KR*66()-270[]D	\$6,680	\$8,390	\$6,280	\$7,700	27,000	36,450	5,070	119.13	15.32	15.9	265

* See technical bulletin for use of D for DOE/NRCan compliant model or A for non-regulated.

Two speed EC motors are standard; deduct for PSC "B" or add for variable speed EC "V" motors.

[] Refrigerant letter. Include price adder for circuiting with B - glycol and C - CO₂.

Available Types of Defrost

(H) = HGE 3 Pipe Hot Gas with Electric Pan Heat - No defrost termination or fan delay

(G) = HGG 3 Pipe Hot Gas with Gas Pan Heat - No defrost termination or fan delay

(P) = KGE 2 Pipe Kool Gas with Electric Pan Heat

(K) = KGG 2 Pipe Kool Gas with Gas Pan Heat

- DOE/NRCan models are shown and can be applied for non-regulated applications without controls.
- Confirm AWEF for refrigerant being applied and select variable speed motor if required.
- Controls for two speed or variable speed are not included in unit pricing shown.
- Select from controls options on Unit Cooler Accessories.
- Capacities shown reflect midpoint evaporating temperature.



MK / MV PRODUCT DESCRIPTION - MEDIUM PROFILE EVAPORATORS

Version: **July 2020**

MK / MV MODEL KEY

	MK	D	2	6	E	-	152	T	V	A	A	
Unit Type	MK - Medium Profile MV - High Velocity											
DOE Application	D - DOE and NRCan A - Non-Regulated											
Number of Fans												
Fin Spacing												
Type of Defrost	A - Air Defrost E - Electric Defrost w/Electric Pan Heat G - 3 Pipe Hot Gas w/Gas Pan Heat H - 3 Pipe Hot Gas w/Electric Pan Heat K - 2 Pipe Kool Gas w/Gas Pan Heat P - 2 Pipe Kool Gas w/Electric Pan Heat R - Heat Reclaim											
											Heater Voltage A - 208-230/1/60 B - 115/1/60* K - 208-230/3/60 M - 460/3/60	
											Motor Voltage A - 208-230/1/60 B - 115/1/60 K - 208-230/3/60 (1) H - 460/1/60 (2) M - 460/3/60 (1) (2)	
											Motor Type (3) V - Variable Speed EC D - Variable Speed EC, 2 Speed Control B - PSC Motors	
											Refrigerant N - Non-Glide S - R-404A P - R-507A B - Glycol G - Glide Refrigerants Q - R-407A F - R-407F T - R-448A R - R-449A	
											BTU/h in Hundreds (00)	

* Available on pan heaters for H and P defrost options only.



- (1) Single phase motors wired for three phase operation. Not available on single fan units.
- (2) 460 V motors are Motor Type PSC only and not available for DOE or NRCan regulated applications.
- (3) EC motor required for DOE with variable speed or two speed control option are A, B or K motor voltage only.

Prices, product availability, and specifications are subject to change without notice.



MK / MV PRODUCT DESCRIPTION - MEDIUM PROFILE EVAPORATORS

Version: **July 2020**

AIR DEFROST - MEDIUM TEMPERATURE

MODEL	LIST PRICE	CAPACITY (BTUH) @ 10° F TD	AIR FLOW (CFM)	DIMENSIONS (IN)			SHIP WGT. (LBS)
		+20 Evap		L	W	H	
MK*18A-133[]V	\$2,940	13,300	2,710	38	19	26.75	125
MK*18A-160[]V	\$3,030	16,000	2,625	38	19	26.75	130
MK*28A-266[]V	\$5,150	26,600	5,420	63	19	26.75	225
MK*28A-320[]V	\$6,120	32,000	5,250	63	19	26.75	240
MK*38A-393[]V	\$8,660	39,300	8,130	92	19	26.75	330
MK*38A-480[]V	\$9,420	48,000	7,875	92	19	26.75	350
MK*48A-640[]V	\$11,260	64,000	10,500	119	19	26.75	470
MK*16A-118[]V	\$2,710	11,800	2,815	38	19	26.75	125
MK*16A-145[]V	\$2,970	14,500	2,725	38	19	26.75	130
MK*26A-236[]V	\$4,940	23,600	5,630	63	19	26.75	225
MK*26A-290[]V	\$5,840	29,000	5,450	63	19	26.75	240
MK*36A-354[]V	\$7,420	35,400	8,445	92	19	26.75	330
MK*36A-435[]V	\$9,050	43,500	8,175	92	19	26.75	350
MK*46A-580[]V	\$10,910	58,000	10,900	119	19	26.75	470
MK*14A-094[]V	\$2,200	9,400	3,060	38	19	26.75	125
MK*14A-121[]V	\$2,890	12,100	2,960	38	19	26.75	130
MK*24A-188[]V	\$4,270	18,800	6,120	63	19	26.75	225
MK*24A-242[]V	\$5,020	24,200	5,920	63	19	26.75	240
MK*34A-363[]V	\$7,780	36,300	8,880	92	19	26.75	350
MK*44A-484[]V	\$10,370	48,400	11,840	119	19	26.75	470

* See technical bulletin for use of D for DOE/NRCan compliant model or A for non-regulated.

Variable Speed EC motors are standard; deduct for PSC "B" or specify two speed control "D".

Variable Speed EC motors are 115 V or 208-230 V power only and use 0-10 V DC control signal.

Two speed control will need 10 V DC signal to operate at minimum speed.

[] Refrigerant letter. Include price adder for circuiting with B - glycol and C - CO₂.

MK / MV MODEL OPTIONS

No. of Fans	Two Speed EC Motor Adder*	PSC Motor Deduct*	Electro Fin (Air or Gas Defrost only)	Copper Fin	Painted Cabinet White/Black	Long Throw Adapters	Heat Reclaim, Glycol or CO ₂ Circuiting
1	\$0	(\$400)	\$1,480	\$810	\$690	\$230	\$280
2	\$0	(\$800)	\$1,710	\$1,620	\$690	\$460	\$280
3	\$0	(\$1,200)	\$2,430	\$2,430	\$820	\$690	\$280
4	\$0	(\$1,600)	\$3,160	\$3,240	\$870	\$920	\$280

No. of Fans	Insulated Aluminum Drain Pan	SS Long Throw Adapters	SS Non Ins Drain Pan (only)	SS Insulated Drain Pan (only)	SS Housing & SS Non Ins Drain Pan	SS Housing & SS Insulated Drain Pan
1	\$430	\$560	\$670	\$1,320	\$1,500	\$2,230
2	\$540	\$1,120	\$840	\$1,630	\$1,870	\$2,780
3	\$710	\$1,680	\$1,100	\$1,970	\$2,550	\$3,580
4	\$1,140	\$2,240	\$1,770	\$3,000	\$3,710	\$5,140

- DOE/NRCan models are shown and can be applied for non-regulated applications without controls.
- Confirm AWEF for refrigerant being applied and select variable or two speed motor as required.
- Controls for two speed or variable speed are not included in unit pricing shown.
- Select from controls options on Unit Cooler Accessories.
- Capacities shown reflect midpoint evaporating temperature.



MK / MV PRODUCT DESCRIPTION - MEDIUM PROFILE EVAPORATORS

Version: July 2020

ELECTRIC DEFROST - LOW / MEDIUM TEMPERATURE

MODEL	LIST PRICE	CAPACITY (BTUH) @ 10° F TD		AIR FLOW (CFM)	DIMENSIONS (IN)			SHIP WGT (LBS)
		-20 Evap	+20 Evap		L	W	H	
MK*16E-103[]V	\$3,440	10,300	11,800	2,815	38	19	26.75	125
MK*16E-127[]V	\$3,630	12,700	14,500	2,725	38	19	26.75	130
MK*26E-206[]V	\$5,940	20,600	23,600	5,630	63	19	26.75	225
MK*26E-254[]V	\$7,220	25,400	29,000	5,450	63	19	26.75	240
MK*36E-309[]V	\$8,670	30,900	35,400	8,445	92	19	26.75	330
MK*36E-381[]V	\$9,830	38,100	43,500	8,175	92	19	26.75	350
MK*46E-508[]V	\$11,630	50,800	58,000	10,900	119	19	26.75	470
MK*14E-082[]V	\$3,400	8,200	9,400	3,060	38	19	26.75	125
MK*14E-105[]V	\$3,570	10,500	12,100	2,960	38	19	26.75	130
MK*24E-164[]V	\$5,810	16,400	18,800	6,120	63	19	26.75	225
MK*24E-210[]V	\$7,100	21,000	24,200	5,920	63	19	26.75	240
MK*34E-246[]V	\$8,530	24,600	28,200	9,180	92	19	26.75	330
MK*34E-315[]V	\$9,640	31,500	36,300	8,880	92	19	26.75	350
MK*44E-420[]V	\$11,410	42,000	48,400	11,840	119	19	26.75	470

* See technical bulletin for use of D for DOE/NRCan compliant model or A for non-regulated.

LOW TEMPERATURE - BELOW +30° F EXTRA HIGH VELOCITY

MODEL	LIST PRICE	CAPACITY (BTUH) @ 10° F TD		AIR FLOW (CFM)	DIMENSIONS (IN)			SHIP WGT (LBS)
		-20 Evap	+20 Evap		L	W	H	
MVA16E-126[]V	\$4,240	12,600	N/A	3,955	38	19	26.75	125
MVA16E-155[]V	\$4,940	15,500	N/A	3,800	38	19	26.75	130
MVA26E-252[]V	\$7,090	25,200	N/A	7,910	63	19	26.75	225
MVA26E-310[]V	\$8,470	31,000	N/A	7,600	63	19	26.75	240
MVA36E-378[]V	\$10,110	37,800	N/A	11,865	92	19	26.75	330
MVA36E-465[]V	\$11,480	46,500	N/A	11,400	92	19	26.75	350
MVA46E-620[]V	\$13,520	62,000	N/A	15,200	119	19	26.75	470
MVA14E-100[]V	\$4,020	10,000	N/A	4,300	38	19	26.75	125
MVA14E-128[]V	\$4,600	12,800	N/A	4,130	38	19	26.75	130
MVA24E-200[]V	\$7,010	20,000	N/A	8,600	63	19	26.75	225
MVA24E-256[]V	\$8,280	25,600	N/A	8,260	63	19	26.75	240
MVA34E-300[]V	\$9,920	30,000	N/A	12,900	92	19	26.75	330
MVA34E-384[]V	\$11,260	38,400	N/A	12,390	92	19	26.75	350
MVA44E-512[]V	\$13,260	51,200	N/A	16,520	119	19	26.75	470

* MV models are A for non-regulated applications only.

Variable Speed EC motors are standard; deduct for PSC "B" or specify two speed control "D".

Variable Speed EC motors are 115 V or 208-230 V power only and use 0-10 V DC control signal.

Two speed control will need 10V DC signal to operate at minimum speed.

[] Refrigerant letter. Include price adder for circuiting with B - glycol and C - CO₂.

- DOE/NRCan models are shown for MK and can be applied for non-regulated applications without controls.
- MV models are for non-regulated options and operates as single speed without controls.
- Confirm AWEF for refrigerant being applied and select variable or two speed motor as required.
- Controls for two speed or variable speed are not included in unit pricing shown.
- Select from controls options on Unit Cooler Accessories.
- Capacities shown reflect midpoint evaporating temperature.



MK / MV PRODUCT DESCRIPTION - MEDIUM PROFILE EVAPORATORS

Version: **July 2020**

HOT GAS DEFROST - LOW / MEDIUM TEMPERATURE

MODEL	LIST PRICE BY DEFROST TYPE				CAPACITY (BTUH) @ 10° F		AIR FLOW (CFM)	DIMENSIONS (IN)			SHIP WGT (LBS)
	(P)	(K)	(H)	(G)	-20 Evap	+20 Evap		L	W	H	
	MK*16()-103[]V	\$3,370	\$3,800	\$3,120	\$3,570	10,300	11,800	2,815	38	19	26.75
MK*16()-127[]V	\$3,550	\$4,000	\$3,310	\$3,750	12,700	14,500	2,725	38	19	26.75	130
MK*26()-206[]V	\$5,790	\$6,510	\$5,540	\$6,250	20,600	23,600	5,630	63	19	26.75	225
MK*26()-254[]V	\$7,030	\$7,960	\$6,790	\$7,710	25,400	29,000	5,450	63	19	26.75	240
MK*36()-309[]V	\$8,330	\$9,530	\$8,070	\$9,280	30,900	35,400	8,445	92	19	26.75	330
MK*36()-381[]V	\$9,430	\$10,820	\$9,180	\$10,560	38,100	43,500	8,175	92	19	26.75	350
MK*46()-508[]V	\$11,150	\$12,750	\$10,900	\$12,510	50,800	58,000	10,900	119	19	26.75	470
MK*14()-082[]V	\$3,240	\$3,660	\$3,000	\$3,410	8,200	9,400	3,060	38	19	26.75	125
MK*14()-105[]V	\$3,390	\$3,830	\$3,140	\$3,590	10,500	12,100	2,960	38	19	26.75	130
MK*24()-164[]V	\$5,550	\$6,230	\$5,300	\$5,980	16,400	18,800	6,120	63	19	26.75	225
MK*24()-210[]V	\$6,770	\$7,630	\$6,530	\$7,390	21,000	24,200	5,920	63	19	26.75	240
MK*34()-246[]V	\$8,000	\$9,130	\$7,750	\$8,880	24,600	28,200	9,180	92	19	26.75	330
MK*34()-315[]V	\$9,030	\$10,360	\$8,800	\$10,110	31,500	36,300	8,880	92	19	26.75	350
MK*44()-420[]V	\$10,700	\$12,220	\$10,450	\$11,980	42,000	48,400	11,840	119	19	26.75	470

* See technical bulletin for use of D for DOE/NRCan compliant model or A for non-regulated.

Variable Speed EC motors are standard; deduct for PSC "B" or specify two speed control "D".

Variable Speed EC motors are 115 V or 208-230 V power only and use 0-10 V DC control signal.

Two speed control will need 10 V DC signal to operate at minimum speed.

[] Refrigerant letter. Include price adder for circuiting with B - glycol and C - CO₂.

Available Types of Defrost

(H) = HGE 3 Pipe Hot Gas with Electric Pan Heat - No defrost termination or fan delay

(G) = HGG 3 Pipe Hot Gas with Gas Pan Heat - No defrost termination or fan delay

(P) = KGE 2 Pipe Kool gas with Electric Pan Heat

(K) = KGG 2 Pipe Kool Gas with Gas Pan Heat

- DOE/NRCan models are shown and can be applied for non-regulated applications without controls.
- Confirm AWEF for refrigerant being applied and select variable or two speed motor as required.
- Controls for two speed or variable speed are not included in unit pricing shown.
- Select from controls options on Unit Cooler Accessories.
- Capacities shown reflect midpoint evaporating temperature.

Prices, product availability, and specifications
are subject to change without notice.



MS PRODUCT DESCRIPTION - MEDIUM PROFILE EVAPORATORS

Version: **July 2020**

MS MODEL KEY

	MS	A	2	6	E	-	0390	T	C	K	K	
Unit Type												Heater Voltage
MS - Super Cooler												A - 208-230/1/60
DOE Application												K - 208-230/3/60
D - DOE and NRCan												L - 380/3/60 (1)
A - Non-Regulated												M - 460/3/60
Number of Fans												P - 575/3/60
Fin Spacing												Motor Voltage
4, 5, 6, 7 FPI												A - 208-230/1/60
Type of Defrost												M - 460/3/60
A - Air Defrost												B - 115/1/60
E - Electric Defrost w/Electric Pan Heat												P - 575/3/60
G - 3 Pipe Hot Gas w/Gas Pan Heat												K - 208-230/3/60
H - 3 Pipe Hot Gas w/Electric Pan Heat												U - 380/3/50
K - 2 Pipe Kool Gas w/Gas Pan Heat												L - 380/3/60 (1)
P - 2 Pipe Kool Gas w/Electric Pan Heat												Motor Type (3)
R - Heat Reclaim												C - 3 Phase Motors (2)
												V - Variable Speed EC (3)
												D - Variable Speed EC, 2 Speed Control
												Refrigerant
												N - Non-Glide
												S - R-404A
												P - R-507A
												B - Glycol
												G - Glide Refrigerants
												Q - R-407A
												T - R-448A
												F - R-407F
												R - R-449A
												BTU/h in Hundreds (00)

(1) Contact application engineering for quoting.

(2) Invertor suitable motor for K, M, P, and U voltages.

(3) Single phase motor available in motor voltage 115/1/60, 208-230/1/60 and 208-230/3/60 (with 2 or more fans).



DOE or NRC applications use variable speed motors with two speed or variable speed control.

Prices, product availability, and specifications are subject to change without notice.



**MS PRODUCT DESCRIPTION -
MEDIUM PROFILE EVAPORATORS**

Version: **July 2020**

AIR DEFROST - MEDIUM TEMPERATURE

MODEL	LIST PRICE	CAPACITY (BTUH) @ 10° F TD	AIR FLOW (CFM)	DIMENSIONS (IN)			SHIP WGT (LBS)
		+25 Evap		L	W	H	
MS*14A-0150[]C	\$3,440	15,020	4200	57.00	26.625	26.25	142
MS*14A-0190[]C	\$4,210	19,030	4120	57.00	26.625	26.25	153
MS*14A-0225[]C	\$4,770	22,470	4000	57.00	26.625	26.25	171
MS*14A-0249[]C	\$5,290	24,910	3920	57.00	26.625	26.25	184
MS*16A-0184[]C	\$3,570	18,360	4120	57.00	26.625	26.25	151
MS*16A-0229[]C	\$4,330	22,940	4040	57.00	26.625	26.25	164
MS*16A-0260[]C	\$4,930	26,010	3940	57.00	26.625	26.25	182
MS*16A-0281[]C	\$5,470	28,100	3850	57.00	26.625	26.25	197
MS*17A-0199[]C	\$3,620	19,880	4080	57.00	26.625	26.25	161
MS*17A-0246[]C	\$4,420	24,590	4000	57.00	26.625	26.25	174
MS*17A-0275[]C	\$5,020	27,500	3900	57.00	26.625	26.25	194
MS*17A-0295[]C	\$5,570	29,540	3800	57.00	26.625	26.25	209
MS*24A-0300[]C	\$5,760	30,040	8400	102.00	26.625	26.25	247
MS*24A-0381[]C	\$7,320	38,050	8240	102.00	26.625	26.25	272
MS*24A-0450[]C	\$8,260	44,950	8000	102.00	26.625	26.25	301
MS*24A-0498[]C	\$8,920	49,820	7840	102.00	26.625	26.25	326
MS*26A-0367[]C	\$5,930	36,710	8240	102.00	26.625	26.25	269
MS*26A-0459[]C	\$7,550	45,880	8080	102.00	26.625	26.25	297
MS*26A-0520[]C	\$8,510	52,030	7880	102.00	26.625	26.25	328
MS*26A-0562[]C	\$9,190	56,190	7700	102.00	26.625	26.25	355
MS*27A-0398[]C	\$6,060	39,760	8160	102.00	26.625	26.25	309
MS*27A-0492[]C	\$7,700	49,180	8000	102.00	26.625	26.25	342
MS*27A-0550[]C	\$8,670	55,000	7800	102.00	26.625	26.25	370
MS*27A-0591[]C	\$9,370	59,080	7600	102.00	26.625	26.25	419
MS*34A-0524[]C	\$9,930	52,400	12135	129.00	26.625	26.25	369
MS*34A-0623[]C	\$11,270	62,250	11505	129.00	26.625	26.25	402
MS*34A-0708[]C	\$12,010	70,820	11325	129.00	26.625	26.25	433
MS*36A-0626[]C	\$10,240	62,610	11895	129.00	26.625	26.25	402
MS*36A-0712[]C	\$11,620	71,180	11040	129.00	26.625	26.25	438
MS*36A-0806[]C	\$12,390	80,620	10995	129.00	26.625	26.25	472
MS*37A-0663[]C	\$10,470	66,340	11700	129.00	26.625	26.25	419
MS*37A-0755[]C	\$12,340	75,540	10995	129.00	26.625	26.25	456
MS*37A-0849[]C	\$12,640	84,870	10905	129.00	26.625	26.25	492
MS*44A-0699[]C	\$12,960	69,870	16180	168.00	26.625	26.25	493
MS*44A-0830[]C	\$14,040	83,000	15340	168.00	26.625	26.25	528
MS*44A-0944[]C	\$15,430	94,430	15100	168.00	26.625	26.25	578
MS*46A-0835[]C	\$13,360	83,480	15860	168.00	26.625	26.25	538
MS*46A-0949[]C	\$14,470	94,900	14720	168.00	26.625	26.25	576
MS*46A-1075[]C	\$15,930	107,490	14660	168.00	26.625	26.25	630
MS*47A-0885[]C	\$13,640	88,450	15600	168.00	26.625	26.25	560
MS*47A-1007[]C	\$14,800	100,720	14660	168.00	26.625	26.25	600
MS*47A-1132[]C	\$16,300	113,170	14540	168.00	26.625	26.25	656

* See technical bulletin for use of D for DOE/NRCan compliant model or A for non-regulated.

3 phase motors for use in non-regulated applications are standard.

Variable Speed EC motors are 115 V or 208-230 V power only and use 0-10 V DC control signal.

Two speed control will need 10 V DC signal to operate at minimum speed.

[] Refrigerant letter. Include price adder for circuiting with B - glycol.

- Non-regulated models are shown with single speed 3 phase motors.
- Confirm AWEF for refrigerant being applied and select variable or two speed motor as required.
- Controls for two speed or variable speed are not included in unit pricing shown.
- Select from controls options on Unit Cooler Accessories.
- Capacities shown reflect midpoint evaporating temperature.



**MS PRODUCT DESCRIPTION -
MEDIUM PROFILE EVAPORATORS**

Version: **July 2020**

ELECTRIC DEFROST - MEDIUM / LOW TEMPERATURE

MODEL	LIST PRICE	CAPACITY (BTUH) @ 10° F TD		AIR FLOW (CFM)	DIMENSIONS (IN)			SHIP WGT (LBS)
		-20 Evap	+20 Evap		L	W	H	
MS*14E-0162[]C	\$4,900	16,180	19,030	4,120	57	26.625	26.25	174
MS*14E-0212[]C	\$6,060	21,170	24,910	3,920	57	26.625	26.25	208
MS*15E-0178[]C	\$4,970	17,790	20,930	4,060	57	26.625	26.25	186
MS*15E-0223[]C	\$6,160	22,260	26,190	3,890	57	26.625	26.25	221
MS*16E-0195[]C	\$5,050	19,500	22,940	4,040	57	26.625	26.25	198
MS*16E-0239[]C	\$6,230	23,890	28,100	3,850	57	26.625	26.25	236
MS*24E-0323[]C	\$10,400	32,340	38,050	8,240	102	26.625	26.25	297
MS*24E-0424[]C	\$11,400	42,350	49,820	7,840	102	26.625	26.25	357
MS*25E-0356[]C	\$10,560	35,580	41,860	8,120	102	26.625	26.25	317
MS*25E-0444[]C	\$11,600	44,450	52,290	7,780	102	26.625	26.25	381
MS*26E-0390[]C	\$10,720	39,000	45,880	8,080	102	26.625	26.25	337
MS*26E-0478[]C	\$11,760	47,760	56,190	7,700	102	26.625	26.25	406
MS*34E-0445[]C	\$12,160	44,540	52,400	12,135	129	26.625	26.25	398
MS*34E-0602[]C	\$13,210	60,200	70,820	11,325	129	26.625	26.25	470
MS*35E-0502[]C	\$12,370	50,180	59,030	12,015	129	26.625	26.25	425
MS*35E-0643[]C	\$13,410	64,330	75,680	11,205	129	26.625	26.25	502
MS*36E-0532[]C	\$12,550	53,220	62,610	11,895	129	26.625	26.25	452
MS*36E-0685[]C	\$13,590	68,530	80,620	10,995	129	26.625	26.25	534
MS*44E-0594[]C	\$15,570	59,390	69,870	16,180	168	26.625	26.25	541
MS*44E-0803[]C	\$17,940	80,270	94,430	15,100	168	26.625	26.25	616
MS*45E-0669[]C	\$15,810	66,900	78,710	16,020	168	26.625	26.25	578
MS*45E-0858[]C	\$18,210	85,770	100,910	14,940	168	26.625	26.25	658
MS*46E-0710[]C	\$16,050	70,960	83,480	15,860	168	26.625	26.25	615
MS*46E-0914[]C	\$18,500	91,370	107,490	14,660	168	26.625	26.25	700

* See technical bulletin for use of D for DOE/NRCan compliant model or A for non-regulated.

3 phase motors for use in non-regulated applications are standard.

Variable Speed EC motors are 115 V or 208-230 V power only and use 0-10 V DC control signal.

Two speed control will need 10 V DC signal to operate at minimum speed.

[] Refrigerant letter. Include price adder for circuiting with B - glycol.

MS MODEL OPTIONS

No. of Fans	VS EC Motor*	Electrofin (Air or Gas Defrost only)	Copper Fin	Painted Housing White/ Black	Long Throw Adapters	Heat Reclaim or Glycol Circuiting
1	\$140	\$1,900	\$1,870	\$690	\$280	\$280
2	\$280	\$2,670	\$3,740	\$690	\$560	\$280
3	\$420	\$3,400	\$5,610	\$820	\$840	\$280
4	\$560	\$4,470	\$7,480	\$1,000	\$1,120	\$280

No. of Fans	SS Long Throw Adapter	Galvanized Insulated Drain Pan	SS Drain Pan	SS Insulated Drain Pan	SS Housing & SS Drain Pan	SS Housing & SS Ins Drain Pan
1	\$840	\$490	\$640	\$1,290	\$2,010	\$2,790
2	\$1,680	\$860	\$1,150	\$2,270	\$3,150	\$4,470
3	\$2,520	\$1,050	\$2,220	\$3,310	\$5,060	\$6,430
4	\$3,360	\$1,390	\$2,560	\$4,100	\$5,980	\$7,870

- Non-regulated models are shown with single speed 3 phase motors.
- Confirm AWEF for refrigerant being applied and select variable or two speed motor as required.
- Controls for two speed or variable speed are not included in unit pricing shown.
- Select from controls options on Unit Cooler Accessories.
- Capacities shown reflect midpoint evaporating temperature.



**MS PRODUCT DESCRIPTION -
MEDIUM PROFILE EVAPORATORS**

Version: **July 2020**

GAS DEFROST - MEDIUM / LOW TEMPERATURE

MODEL	LIST PRICE BY DEFROST TYPE				CAPACITY (BTUH) @ 10° F TD		AIR FLOW (CFM)	DIMENSIONS (IN)			SHIP WGT (LBS)
	(P)	(K)	(H)	(G)	-20 Evap	+20 Evap		L	W	H	
	MS*14()-0162[]C	\$4,770	\$6,040	\$4,560	\$5,980	16,180	19,030	4,120	57	26.63	26.25
MS*14()-0212[]C	\$5,910	\$7,300	\$5,640	\$7,240	21,170	24,910	3,920	57	26.63	26.25	208
MS*15()-0178[]C	\$4,860	\$6,120	\$4,630	\$6,090	17,790	20,930	4,060	57	26.63	26.25	186
MS*15()-0223[]C	\$5,990	\$7,390	\$5,730	\$7,370	22,260	26,190	3,890	57	26.63	26.25	221
MS*16()-0195[]C	\$4,930	\$6,190	\$4,700	\$6,180	19,500	22,940	4,040	57	26.63	26.25	198
MS*16()-0239[]C	\$6,090	\$7,500	\$5,800	\$7,500	23,890	28,100	3,850	57	26.63	26.25	236
MS*24()-0323[]C	\$10,130	\$12,360	\$9,670	\$12,250	32,340	38,050	8,240	102	26.63	26.25	297
MS*24()-0424[]C	\$11,120	\$13,450	\$10,620	\$13,330	42,350	49,820	7,840	102	26.63	26.25	357
MS*25()-0356[]C	\$10,300	\$12,530	\$9,830	\$12,490	35,580	41,860	8,120	102	26.63	26.25	317
MS*25()-0444[]C	\$11,290	\$13,640	\$10,760	\$13,580	44,450	52,290	7,780	102	26.63	26.25	381
MS*26()-0390[]C	\$10,460	\$12,700	\$9,960	\$12,690	39,000	45,880	8,080	102	26.63	26.25	337
MS*26()-0478[]C	\$11,470	\$13,830	\$10,950	\$13,800	47,760	56,190	7,700	102	26.63	26.25	406
MS*34()-0445[]C	\$11,870	\$14,510	\$11,320	\$14,390	44,540	52,400	12,135	129	26.63	26.25	398
MS*34()-0602[]C	\$12,880	\$15,660	\$12,290	\$15,510	60,200	70,820	11,325	129	26.63	26.25	470
MS*35()-0502[]C	\$12,050	\$14,730	\$11,500	\$14,600	50,180	59,030	12,015	129	26.63	26.25	425
MS*35()-0643[]C	\$13,050	\$15,870	\$12,470	\$15,760	64,330	75,680	11,205	129	26.63	26.25	502
MS*36()-0532[]C	\$12,240	\$14,930	\$11,680	\$14,850	53,220	62,610	11,895	129	26.63	26.25	452
MS*36()-0685[]C	\$13,260	\$16,080	\$12,650	\$16,050	68,530	80,620	10,995	129	26.63	26.25	534
MS*44()-0594[]C	\$15,180	\$18,550	\$14,470	\$18,400	59,390	69,870	16,180	168	26.63	26.25	541
MS*44()-0803[]C	\$17,500	\$21,150	\$16,690	\$20,970	80,270	94,430	15,100	168	26.63	26.25	616
MS*45()-0669[]C	\$15,410	\$18,800	\$14,700	\$18,710	66,900	78,710	16,020	168	26.63	26.25	578
MS*45()-0858[]C	\$17,760	\$21,440	\$16,940	\$21,320	85,770	100,910	14,940	168	26.63	26.25	658
MS*46()-0710[]C	\$15,640	\$19,070	\$14,920	\$19,020	70,960	83,480	15,860	168	26.63	26.25	615
MS*46()-0914[]C	\$18,030	\$21,760	\$17,200	\$21,730	91,370	107,490	14,660	168	26.63	26.25	700

* See technical bulletin for use of D for DOE/NRC compliant model or A for non-regulated.

3 phase motors for use in non-regulated applications are standard.

Variable Speed EC motors are 115 V or 208-230 V power only and use 0-10 V DC control signal.

Two speed control will need 10 V DC signal to operate at minimum speed.

[] Refrigerant letter. Include price adder for circuiting with B - glycol.

Available Types of Defrost

(H) = HGE 3 Pipe Gas Defrost with Electric Pan heat

(G) = HGG 3 Pipe Gas Defrost with Gas Pan Heat

(P) = KGE 2 Pipe Kool Gas Defrost with Electric Pan Heat

(K) = KGG 2 Pipe Kool Gas Defrost with Gas Pan Heat

- Non-regulated models are shown with single speed 3 phase motors.
- Confirm AWEF for refrigerant being applied and select variable or two speed motor as required.
- Controls for two speed or variable speed are not included in unit pricing shown.
- Select from controls options on Unit Cooler Accessories.
- Capacities shown reflect midpoint evaporating temperature.

Prices, product availability, and specifications are subject to change without notice.



SM / SV PRODUCT DESCRIPTION - HIGH PROFILE EVAPORATORS

Version: **July 2020**

SM / SV MODEL KEY

	SM	A	2	5	E	-	0842	T	C	K	K	
Unit Type	SM - Space Master SV - High Velocity											Heater Voltage
DOE Application	D - DOE and NRCan A - Non-Regulated											K - 208-230/3/60 M - 460/3/60 P - 575/3/60 U - 380/3/50 L - 380/3/60 (1)
Number of Fans												Motor Voltage
Fin Spacing	4, 5, 6, 7 FPI											K - 208-230/3/60 M - 460/3/60 P - 575/3/60 U - 380/3/50 L - 380/3/60 (1)
Type of Defrost	A - Air Defrost E - Electric Defrost w/Electric Pan Heat G - 3 Pipe Hot Gas w/Gas Pan Heat H - 3 Pipe Hot Gas w/Electric Pan Heat K - 2 Pipe Kool Gas w/Gas Pan Heat P - 2 Pipe Kool Gas w/Electric Pan Heat R - Heat Reclaim											Motor Type (3)
												C - 3 Phase Motors (2) V - Variable Speed EC, 3 Phase D - Variable Speed EC, 2 Speed Control
												Refrigerant
												N - Non-Glide S - R-404A P - R-507A B - Glycol
												G - Glide Refrigerants Q - R-407A T - R-448A F - R-407F R - R-449A
												BTU/h in Hundreds (00)

- (1) Contact application engineering for quoting
- (2) Invertor suitable motor for K, M, P, and U voltages with 3 phase motors.
- (3) Available in K, M, U and L motor voltages.



DOE and NRCan applications with two speed or variable speed control.

Prices, product availability, and specifications are subject to change without notice.



**SM / SV PRODUCT DESCRIPTION -
HIGH PROFILE EVAPORATORS**

Version: **July 2020**

AIR DEFROST - MEDIUM TEMPERATURE

MODEL	LIST PRICE	CAPACITY (BTUH) 10° F TD	AIR FLOW (CFM)	DIMENSIONS (IN)			SHIP WGT (LBS)
				L	W	H	
SM*14A-0314[]C	\$6,500	31,400	9,860	77.0	38.5	40.5	410
SM*16A-0378[]C	\$6,820	37,800	8,980	77.0	38.5	40.5	445
SM*17A-0410[]C	\$6,980	41,000	8,550	77.0	38.5	40.5	465
SM*14A-0403[]C	\$7,350	40,300	9,690	77.0	38.5	40.5	430
SM*16A-0463[]C	\$7,580	46,300	8,810	77.0	38.5	40.5	470
SM*17A-0503[]C	\$7,890	50,300	8,390	77.0	38.5	40.5	490
SM*14A-0469[]C	\$8,020	46,900	9,510	77.0	38.5	40.5	450
SM*16A-0538[]C	\$8,260	53,800	8,480	77.0	38.5	40.5	495
SM*17A-0585[]C	\$8,850	58,500	8,100	77.0	38.5	40.5	515
SM*14A-0526[]C	\$8,870	52,600	9,330	77.0	38.5	40.5	484
SM*16A-0604[]C	\$8,990	60,400	8,400	77.0	38.5	40.5	530
SM*17A-0657[]C	\$9,090	65,700	8,000	77.0	38.5	40.5	550
SM*24A-0619[]C	\$10,380	61,900	19,700	134.25	38.5	40.5	830
SM*26A-0746[]C	\$10,630	74,600	17,900	134.25	38.5	40.5	885
SM*27A-0811[]C	\$10,990	81,100	17,100	134.25	38.5	40.5	940
SM*24A-0797[]C	\$11,910	79,700	19,380	134.25	38.5	40.5	836
SM*26A-0915[]C	\$12,370	91,500	17,600	134.25	38.5	40.5	895
SM*27A-0995[]C	\$14,060	99,500	16,800	134.25	38.5	40.5	950
SM*24A-0882[]C	\$14,990	88,200	18,890	134.25	38.5	40.5	845
SM*26A-1063[]C	\$15,760	106,300	16,900	134.25	38.5	40.5	905
SM*27A-1155[]C	\$17,120	115,500	16,100	134.25	38.5	40.5	960
SM*24A-1038[]C	\$17,900	103,800	18,400	134.25	38.5	40.5	858
SM*26A-1192[]C	\$18,550	119,200	16,800	134.25	38.5	40.5	915
SM*27A-1296[]C	\$18,640	129,600	15,900	134.25	38.5	40.5	975
SM*34A-1123[]C	\$18,800	112,300	28,600	134.25	38.5	51.0	960
SM*36A-1289[]C	\$19,190	128,900	24,900	134.25	38.5	51.0	1,070
SM*37A-1402[]C	\$19,620	140,200	24,700	134.25	38.5	51.0	1,090
SM*34A-1243[]C	\$20,220	124,300	28,000	134.25	38.5	51.0	1,034
SM*36A-1498[]C	\$20,620	149,800	24,600	134.25	38.5	51.0	1,156
SM*37A-1628[]C	\$21,700	162,800	23,700	134.25	38.5	51.0	1,175
SM*34A-1463[]C	\$22,380	146,300	27,400	134.25	38.5	51.0	1,100
SM*36A-1678[]C	\$22,710	167,800	24,400	134.25	38.5	51.0	1,235
SM*37A-1824[]C	\$24,640	182,400	23,500	134.25	38.5	51.0	1,255
SM*44A-1532[]C	\$25,410	153,200	33,900	173.0	38.5	52.5	1,280
SM*46A-1846[]C	\$25,800	184,600	33,200	173.0	38.5	52.5	1,430
SM*47A-1920[]C	\$26,220	192,000	32,930	173.0	38.5	52.5	1,455
SM*44A-1829[]C	\$28,780	182,900	33,400	173.0	38.5	52.5	1,380
SM*46A-2204[]C	\$29,280	220,400	32,800	173.0	38.5	52.5	1,540
SM*47A-2281[]C	\$29,400	228,100	31,600	173.0	38.5	52.5	1,565
SM*44A-2015[]C	\$30,800	201,500	33,000	173.0	38.5	52.5	1,470
SM*46A-2428[]C	\$31,040	242,800	32,530	173.0	38.5	52.5	1,645
SM*47A-2581[]C	\$31,610	258,100	31,330	173.0	38.5	52.5	1,670

* See technical bulletin for use of D for DOE/NRCan compliant model or A for non-regulated.

3 phase motors for use in non-regulated applications are standard.

Variable Speed EC motors are 208-230/3/60 or 460/3/60 power only.

Include price adder for variable speed motors and control for variable or two speed control.

[] Refrigerant letter. Include price adder for circuiting with B - glycol.

See SM/SV Options page for additional notes.



**SM / SV PRODUCT DESCRIPTION -
HIGH PROFILE EVAPORATORS**

Version: **July 2020**

ELECTRIC DEFROST - MEDIUM TEMPERATURE

MODEL	LIST PRICE	CAPACITY (BTUH) @ 10° F TD		AIR FLOW (CFM)	DIMENSIONS (IN)			SHIP WGT (LBS)
		-20° Evap	+20° Evap		L	W	H	
SM*14E-0384[]C	\$8,990	38,400	40,300	9,690	77.0	38.5	40.5	440
SM*15E-0426[]C	\$10,120	42,600	44,700	9,250	77.0	38.5	40.5	450
SM*16E-0440[]C	\$10,710	44,000	46,300	8,810	77.0	38.5	40.5	470
SM*14E-0501[]C	\$10,860	50,100	52,600	9,330	77.0	38.5	40.5	495
SM*15E-0556[]C	\$11,360	55,600	58,400	8,900	77.0	38.5	40.5	505
SM*16E-0574[]C	\$11,920	57,400	60,400	8,400	77.0	38.5	40.5	530
SM*24E-0759[]C	\$16,260	75,900	79,700	19,380	134.25	38.5	40.5	836
SM*25E-0842[]C	\$17,470	84,200	88,400	18,500	134.25	38.5	40.5	874
SM*26E-0869[]C	\$18,670	86,900	91,500	17,600	134.25	38.5	40.5	912
SM*24E-0989[]C	\$19,310	98,900	103,800	18,400	134.25	38.5	40.5	860
SM*25E-1097[]C	\$21,160	109,700	115,200	17,600	134.25	38.5	40.5	900
SM*26E-1132[]C	\$22,110	113,200	119,200	16,800	134.25	38.5	40.5	920
SM*34E-1070[]C	\$22,540	107,000	112,300	28,600	134.25	38.5	51.0	1,030
SM*35E-1186[]C	\$23,000	118,600	124,500	27,300	134.25	38.5	51.0	1,050
SM*36E-1225[]C	\$23,940	122,500	128,900	24,900	134.25	38.5	51.0	1,060
SM*34E-1393[]C	\$28,000	139,300	146,300	27,400	134.25	38.5	51.0	1,195
SM*35E-1544[]C	\$29,280	154,400	162,100	26,100	134.25	38.5	51.0	1,215
SM*36E-1594[]C	\$30,560	159,400	167,800	25,800	134.25	38.5	51.0	1,240
**SM*44E-1465[]C	\$31,340	146,500	167,000	38,130	173.0	38.5	52.5	1,370
**SM*45E-1523[]C	\$32,770	152,300	173,600	36,400	173.0	38.5	52.5	1,340
**SM*46E-1754[]C	\$34,040	175,400	184,600	33,200	173.0	38.5	52.5	1,400
**SM*44E-1769[]C	\$38,360	176,900	201,800	36,530	173.0	38.5	52.5	1,469
**SM*45E-1985[]C	\$40,160	198,500	226,300	34,800	173.0	38.5	52.5	1,540
**SM*46E-2307[]C	\$42,180	230,700	242,800	32,530	173.0	38.5	52.5	1,600

LOW TEMPERATURE ONLY - BELOW +30°F

MODEL	LIST PRICE	CAPACITY (BTUH) @ 10° F TD		AIR FLOW (CFM)	DIMENSIONS (IN)			SHIP WGT (LBS)
		-20° Evap	+20° Evap		L	W	H	
SVA14E-0422[]C	\$9,450	42,200	-	11250	77.0	38.5	40.5	440
SVA15E-0468[]C	\$10,580	46,800	-	11125	77.0	38.5	40.5	450
SVA16E-0664[]C	\$11,170	66,400	-	11000	77.0	38.5	40.5	530
SVA14E-0550[]C	\$11,340	55,000	-	11250	77.0	38.5	40.5	495
SVA15E-0611[]C	\$11,800	61,100	-	11125	77.0	38.5	40.5	505
SVA16E-0684[]C	\$12,380	68,400	-	11000	77.0	38.5	40.5	540
SVA24E-0834[]C	\$17,190	83,400	-	24225	134.25	38.5	40.5	836
SVA25E-0926[]C	\$18,390	92,600	-	23125	134.25	38.5	40.5	874
SVA26E-1005[]C	\$19,590	100,500	-	22800	134.25	38.5	40.5	912
SVA24E-1088[]C	\$20,180	108,800	-	23000	134.25	38.5	40.5	860
SVA25E-1206[]C	\$22,090	120,600	-	22000	134.25	38.5	40.5	900
SVA26E-1311[]C	\$23,660	131,100	-	21550	134.25	38.5	40.5	920
SVA34E-1177[]C	\$23,940	117,700	-	35750	134.25	38.5	51.0	1,030
SVA35E-1304[]C	\$24,390	130,400	-	34125	134.25	38.5	51.0	1,050
SVA36E-1418[]C	\$25,310	141,800	-	33400	134.25	38.5	51.0	1,060
SVA34E-1530[]C	\$29,400	153,000	-	34250	134.25	38.5	51.0	1,195
SVA35E-1698[]C	\$30,670	169,800	-	32625	134.25	38.5	51.0	1,215
SVA36E-1843[]C	\$31,950	184,300	-	32000	134.25	38.5	51.0	1,240
**SVA44E-1699[]C	\$33,200	169,900	-	47650	173.0	38.5	52.5	1,370
**SVA45E-1883[]C	\$34,630	188,300	-	45500	173.0	38.5	52.5	1,340
**SVA46E-2047[]C	\$35,900	204,700	-	44500	173.0	38.5	52.5	1,400
**SVA44E-2052[]C	\$40,220	205,200	-	45650	173.0	38.5	52.5	1,469
**SVA45E-2274[]C	\$42,020	227,400	-	43600	173.0	38.5	52.5	1,540
**SVA46E-2472[]C	\$44,020	247,200	-	42700	173.0	38.5	52.5	1,600

* See SM/SV Options page for additional notes.

Prices, product availability, and specifications
are subject to change without notice.



SM / SV PRODUCT DESCRIPTION - HIGH PROFILE EVAPORATORS

Version: **July 2020**

GAS DEFROST - MEDIUM TEMPERATURE

MODEL	LIST PRICE BY DEFROST TYPE				CAPACITY (BTUH) @ 10° F TD		AIR FLOW (CFM)	DIMENSIONS (IN)			SHIP WGT (LBS)
	(P)	(K)	(H)	(G)	-20° Evap	+20° Evap		L	W	H	
SM*14(-)-0384[]C	\$10,130	\$10,710	\$9,190	\$9,760	38,400	40,300	9,690	77.0	38.5	40.5	440
SM*15(-)-0426[]C	\$11,020	\$11,590	\$10,070	\$10,640	42,600	44,700	9,250	77.0	38.5	40.5	450
SM*16(-)-0440[]C	\$11,670	\$12,270	\$10,640	\$11,200	44,000	46,300	8,810	77.0	38.5	40.5	470
SM*14(-)-0501[]C	\$11,980	\$12,550	\$10,870	\$11,450	50,100	52,600	9,330	77.0	38.5	40.5	495
SM*15(-)-0556[]C	\$12,410	\$13,000	\$11,320	\$11,890	55,600	58,400	8,900	77.0	38.5	40.5	505
SM*16(-)-0574[]C	\$12,990	\$14,200	\$11,890	\$12,440	57,400	60,400	8,400	77.0	38.5	40.5	530
SM*24(-)-0759[]C	\$17,890	\$18,880	\$16,780	\$17,770	75,900	79,700	19,380	134.25	38.5	40.5	836
SM*25(-)-0842[]C	\$18,180	\$19,180	\$17,080	\$18,060	84,200	88,400	18,500	134.25	38.5	40.5	874
SM*26(-)-0869[]C	\$18,950	\$21,950	\$19,150	\$20,170	86,900	91,500	17,600	134.25	38.5	40.5	912
SM*24(-)-0989[]C	\$24,270	\$25,280	\$20,680	\$21,690	98,900	103,800	18,400	134.25	38.5	40.5	860
SM*25(-)-1097[]C	\$25,400	\$26,400	\$21,780	\$22,780	109,700	115,200	17,600	134.25	38.5	40.5	900
SM*26(-)-1132[]C	\$26,480	\$26,760	\$23,380	\$24,390	113,200	119,200	16,800	134.25	38.5	40.5	920
SM*34(-)-1070[]C	\$27,330	\$28,340	\$23,730	\$24,740	107,000	112,300	28,600	134.25	38.5	51.0	1,030
SM*35(-)-1186[]C	\$27,670	\$28,940	\$24,330	\$25,320	118,600	124,500	27,300	134.25	38.5	51.0	1,050
SM*36(-)-1225[]C	\$28,720	\$29,530	\$25,400	\$26,410	122,500	128,900	24,900	134.25	38.5	51.0	1,060
SM*34(-)-1393[]C	\$29,520	\$32,150	\$27,200	\$28,220	139,300	146,300	27,400	134.25	38.5	51.0	1,195
SM*35(-)-1544[]C	\$32,020	\$33,000	\$28,090	\$29,200	154,400	162,100	26,100	134.25	38.5	51.0	1,215
SM*36(-)-1594[]C	\$33,290	\$34,980	\$31,470	\$32,490	159,400	167,800	25,800	134.25	38.5	51.0	1,240
**SM*44(-)-1465[]C	\$39,230	\$41,930	\$33,440	\$35,020	146,500	167,000	38,130	173.0	38.5	52.5	1,370
**SM*45(-)-1523[]C	\$40,880	\$43,730	\$34,860	\$36,450	152,300	173,600	36,400	173.0	38.5	52.5	1,340
**SM*46(-)-1754[]C	\$42,370	\$45,330	\$36,130	\$37,720	175,400	184,600	33,200	173.0	38.5	52.5	1,400
**SM*44(-)-1769[]C	\$46,770	\$50,720	\$40,930	\$42,520	176,900	201,800	36,530	173.0	38.5	52.5	1,469
**SM*45(-)-1985[]C	\$49,600	\$53,110	\$42,720	\$44,320	198,500	226,300	34,800	173.0	38.5	52.5	1,540
**SM*46(-)-2307[]C	\$51,390	\$55,630	\$39,780	\$45,850	230,700	242,800	32,530	173.0	38.5	52.5	1,600

LOW TEMPERATURE ONLY - BELOW +30°F

MODEL	LIST PRICE BY DEFROST TYPE				CAPACITY (BTUH) @ 10° F TD		AIR FLOW (CFM)	DIMENSIONS (IN)			SHIP WGT (LBS)
	(P)	(K)	(H)	(G)	-20° Evap	+20° Evap		L	W	H	
SVA14(-)-0422[]C	\$10,590	\$11,170	\$9,650	\$10,210	42,200	-	11250	77.0	38.5	40.5	440
SVA15(-)-0468[]C	\$11,480	\$12,040	\$10,520	\$11,100	46,800	-	11125	77.0	38.5	40.5	450
SVA16(-)-0664[]C	\$12,130	\$12,730	\$11,100	\$11,670	66,400	-	11000	77.0	38.5	40.5	530
SVA14(-)-0550[]C	\$12,440	\$13,010	\$11,340	\$11,920	55,000	-	11250	77.0	38.5	40.5	495
SVA15(-)-0611[]C	\$12,880	\$13,470	\$11,770	\$12,340	61,100	-	11125	77.0	38.5	40.5	505
SVA16(-)-0684[]C	\$13,460	\$14,660	\$12,340	\$12,910	68,400	-	11000	77.0	38.5	40.5	540
SVA24(-)-0834[]C	\$18,810	\$19,800	\$17,700	\$18,700	83,400	-	24225	134.25	38.5	40.5	836
SVA25(-)-0926[]C	\$19,100	\$20,100	\$18,000	\$18,990	92,600	-	23125	134.25	38.5	40.5	874
SVA26(-)-1005[]C	\$19,870	\$22,880	\$20,070	\$21,090	100,500	-	22800	134.25	38.5	40.5	912
SVA24(-)-1088[]C	\$25,200	\$26,210	\$21,600	\$22,620	108,800	-	23000	134.25	38.5	40.5	860
SVA25(-)-1206[]C	\$26,320	\$27,320	\$22,700	\$23,700	120,600	-	22000	134.25	38.5	40.5	900
SVA26(-)-1311[]C	\$27,400	\$27,680	\$24,300	\$25,310	131,100	-	21550	134.25	38.5	40.5	920
SVA34(-)-1177[]C	\$28,710	\$29,730	\$25,130	\$26,140	117,700	-	35750	134.25	38.5	51.0	1,030
SVA35(-)-1304[]C	\$29,070	\$30,340	\$25,720	\$26,720	130,400	-	34125	134.25	38.5	51.0	1,050
SVA36(-)-1418[]C	\$30,120	\$30,920	\$26,780	\$27,790	141,800	-	33400	134.25	38.5	51.0	1,060
SVA34(-)-1530[]C	\$30,900	\$33,530	\$28,590	\$29,600	153,000	-	34250	134.25	38.5	51.0	1,195
SVA35(-)-1698[]C	\$33,420	\$34,390	\$29,480	\$30,590	169,800	-	32625	134.25	38.5	51.0	1,215
SVA36(-)-1843[]C	\$34,680	\$36,360	\$32,860	\$33,870	184,300	-	32000	134.25	38.5	51.0	1,240
**SVA44(-)-1699[]C	\$41,080	\$43,780	\$35,290	\$36,870	169,900	-	47650	173.0	38.5	52.5	1,370
**SVA45(-)-1883[]C	\$42,730	\$45,580	\$36,710	\$38,300	188,300	-	45500	173.0	38.5	52.5	1,340
**SVA46(-)-2047[]C	\$44,220	\$47,180	\$37,990	\$39,570	204,700	-	44500	173.0	38.5	52.5	1,400
**SVA44(-)-2052[]C	\$48,620	\$52,570	\$42,790	\$44,370	205,200	-	45650	173.0	38.5	52.5	1,469
**SVA45(-)-2274[]C	\$51,450	\$54,960	\$44,570	\$46,180	227,400	-	43600	173.0	38.5	52.5	1,540
**SVA46(-)-2472[]C	\$53,240	\$57,480	\$41,630	\$47,700	247,200	-	42700	173.0	38.5	52.5	1,600

* See SM/SV Options page for additional notes

Available Types of Defrost

(H) = HGE 3 Pipe Hot Gas with Electric Pan (G) = HGG 3 Pipe Hot Gas with Hot Gas Pan
(P) = KGE 2 Pipe Kool gas with Electric Pan (K) = KGG 2 Pipe Kool Gas with Kool Gas Pan



**SM / SV PRODUCT DESCRIPTION -
HIGH PROFILE EVAPORATORS**

Version: **July 2020**

SM / SV MODEL OPTIONS

Bc"cz : Ubg	JG'97' Actcf f%	9`YWfcZ]b' f5]f'cf'; Ug'	7 cddYf':]b	DU]bhYX'<ci g]b[W\]h#B'UW_	; Uj Ub]nYX' @b['H fck' 5 XUdhYf g	GG'@b[' H fck ' 5 XUdhYf	<YUh FYWUJa 'cf' ; `nVt` 7]fW]]b[
1	\$1,460	\$2,820	\$3,370	\$690	\$350	\$1,150	\$280
2	\$2,920	\$5,100	\$6,740	\$820	\$700	\$2,300	\$280
3	\$4,380	\$6,780	\$10,110	\$870	\$1,050	\$3,450	\$280
4	\$5,840	\$8,910	\$13,480	\$1,060	\$1,400	\$4,600	\$280

Bc"cz : Ubg	hgi `UHYX' 8 fU]b'DUb	GG'8 fU]b'DUb ftb`nL	GG'hgi `UHYX' 8 fU]b'DUb' fA]f'DYZcg]L	GG'<ci g]b[/ ' 8 fU]b'DUb	GG'<ci g]b[' / 'GG' hgi `UHYX' 8 fU]b'DUb' fU]f'XYZcg]L		
1	\$1,030	\$860	\$2,040	\$2,890	\$4,070		
2	\$1,410	\$1,810	\$3,720	\$4,310	\$6,210		
3	\$1,410	\$1,810	\$3,720	\$4,560	\$6,460		
4	\$1,870	\$2,230	\$3,860	\$5,500	\$7,130		

(1) VS EC Motor option is BPM motor with KB electronic drive in control panel.

Notes for SM / SV Models:

* See technical bulletin for use of D for DOE/NRCan compliant model or A for non-regulated.

3 phase motors for use in non-regulated applications are standard
Variable Speed EC motors are 208-230/3/60 or 460/3/60 power only and use 0-10 V DC control signal.
Two speed control will need 10 V DC signal to operate at minimum speed.
[] Refrigerant letter. Include price adder for circuiting with B - glycol.

- Confirm AWEF for refrigerant being applied and select variable or two speed motor as required.
- Controls for two speed or variable speed are not included in unit pricing shown.
- Select from controls options on Unit Cooler Accessories.
- Capacities shown reflect midpoint evaporating temperature.

** 4 fan SM/SV for low temperature application, requires two (2) Expansion Valves.

** Face split is included in the base model price.

- Insulated drain pan is standard on electric and gas defrost models.
- Select optional insulated drain pan for air defrost models when required.

Prices, product availability, and specifications are subject to change without notice.



UNIT COOLER ACCESSORIES*

Version: **July 2020**

OPTIONS

Heater Exchangers:

Condensing Unit HP	Freezer BTU/Hr	Cooler BTU/Hr	Packless Model	Connection Size		KRACK Kit	List Price
				Liquid	Suction		
1	6,500	11,300	HXR50	3/8	5/8	HX-2	\$180
1.5	7,500	20,000	HXR75	3/8	7/8	HX-3	\$190
2	10,000	25,000	HXR100	3/8	1 1/8	HX-4	\$210
3	15,000	30,000	HXR150	1/2	1 1/8	HX-5	\$270
5	25,000	65,000	HXR250A	5/8	1 3/8	HX-6	\$330
7.5	32,500	76,000	HXR350A	5/8	1 5/8	HX-7	\$350
10	61,200	90,000	HXR500	7/8	2 1/8	HX-8	\$600
15	73,000	157,000	HX15	7/8	2 1/8	HX-15	\$900
20	93,000	211,200	HX20	1 1/8	2 1/8	HX-20	\$970
25	118,000	243,600	HX25	1 1/8	2 5/8	HX-25	\$1,120
30	141,000	322,800	HX30	1 3/8	2 5/8	HX-30	\$1,140
50	240,000	420,000	HX35	1 3/8	2 5/8	HX-35	\$1,190
60	280,000	500,000	HX40	1 3/8	3 1/8	HX-40	\$1,330

Mechanical Valves:	List Price	
Expansion Valve - Sporlan	Loose	Mounted
2,000 - 60,000 BTUH	\$330	\$560
60,001 - 150,000 BTUH	\$440	\$560
150,000 - 360,000 BTUH	\$530	\$560
Solenoid Valves Sporlan (specify 115 V or 208-230 V coil)		
2,000 - 40,000 BTUH	\$270	\$740
40,001 - 200,000 BTUH	\$340	\$740
200,001 - 300,000 BTUH	\$480	\$740

Electronic Expansion Valves:	Mounted
EEV Only Sporlan Stepper (HFC/HFO/CO2)	\$780
EEV Only Danfoss PWM (HFC/HFO/CO2)	\$1,280
EEV Only Sporlan PWM (HFC/HFO/CO2)	\$780
<i>Specify coil voltage for PWM valves (24 V, 115 V or 208-240 V)</i>	
EEV orders require refrigerant conditions, coil TD, controller being used, voltage for PWM coil (24 V, 120 V, or 208-240 V), and use for temperature sensors supplied (room temp, termination/coil temp, discharge air, etc).	

Miscellaneous Options:	List Price
Nema 4X Non-Fused Disconnect Switch Mounted (E151572) (MK, MV, MS, SV, SM)	\$620
ALLS - Liquid Stabilizer	\$560
Reheat 4.65KW per fan (MS, SM)	\$2,260
Face Split Coil (MS, SM, SV) (Includes Two Distributors, requires 2 TXV's)	\$660

Evaporator Coil Coatings
Heresite coating is available at two times Electrofin price and can be used with electric defrost. Coil coatings typically increase lead times a week for electrofin and two weeks for Heresite.

No. of Fans	Installed Electrical MK/MV	Installed Electrical MS 208-230 V Elec Def Only	Installed Electrical MS Pan Heater or 460 V Elec Defrost	Installed Electrical SM/SV 208-230 V Only	Installed Electrical SM/SV Pan Heater or 460 V Elec Defrost	Installed electrical includes fuses & relay/contactors for use with mounted control boards and single point power feed to the evaporator. See IOM for reference drawings.
1	\$220	\$270	\$270	\$540	\$270	
2	\$220	\$270	\$270	\$540	\$270	
3	\$270	\$270	\$270	\$540	\$270	
4	\$270	\$540	\$270	\$540	\$270	

* Ship loose items pricing only available on factory orders. Not available on shipments from stock.

Prices, product availability, and specifications are subject to change without notice.



UNIT COOLER ACCESSORIES*

Version: **July 2020**

OPTIONS continued

Temperature and Two Speed Control Options:		
	Loose	Mounted
RT3 Electronic Thermostat	\$310	\$520
R24V Relay 24 V AC - low speed relay for (KR, GL, GH, LH)		\$150
R24P Relay 24V AC + 10V Power Supply - for (MK, MV, MS, SM, SV)		\$350
RT4 Electronic Thermostat + Power Supply 10V DC for vs motor	\$440	\$660
PSUP Power supply 10V DC signal (MK, MV, MS, SM, SV)	\$130	\$310

Temperature and Two Speed Control Notes:
Electronic thermostat Ranco ETC111000, 120/208-240 V, temperature range -30° F to 220° F. Power supply provides 10 V DC signal required for low speed operation with MK, MV, MS, SM and SV. Reference example wiring diagrams in technical bulletins and IOMs for specifics on two speed control.

Variable Speed Control Options:		
	Loose	Mounted
VC4 JCI System 450 - 0-10 V signal for (MK, MV, MS, SM, SV)	\$680	
VC4A JCI System 450 - 0-10 V Signal with 208V control (MK, MV, MS, SM, SV)		\$840
VC4B JCI System 450 - 0-10 V signal with 115V control (MK, MV, MS, SM, SV)		\$840
VC4P JCI System 450 plus amplifier (KR, GL, GH, LH)	\$720	\$940
AMP1 Amplifier 0-10 V DC signal installed (KR, GL, GH, LH)		\$320

Variable Speed Control Notes:
JCI Systems 450 option includes power supply and 0-10 V signal for proportional speed control of evaporator fans between two temperature setpoints. Amplifier is required to boost speed control signal on KR, GL, GH and LH variable speed motors. Reference example wiring diagrams in technical bulletins and IOMs for specifics on variable speed control.

Mounted Controls Options:	
Temp Sensor (CPC, Danfoss, MT, KE2)	\$240
Temp Sensor (Novar)	\$320
Transducer and Superheat Temp for HFC/HFO (CPC, Corelink, Dixell XM67x, Microthermo)	\$520
(Danfoss AK-CC550A or AK-CC750A)	\$780
(KE2)	\$640
Transducer and Superheat Temp for CO2 (Corelink, Dixell XM67x, Microthermo)	\$1,040
(Danfoss AK-CC550A or AK-CC750A)	\$940

KE2Therm Options:	List Price
KE2 EvapOEM Board (installed on MK/MV, MS, AND SM/SV evaporators only)	\$1,390
Remote Display (installed or loose)	\$150
Temp Sensor - specify use (room, coil, term)	\$240
EEV Only Sporlan stepper (HFC/HFO/CO2)	\$780
Transducer & superheat temp for HFC	\$640
Ship Loose Items	
8 Port Switch	\$470
16 Port Switch	\$940
Edge Manager EM35	\$1,940
WiFi Service Tool	\$820

Prices, product availability, and specifications are subject to change without notice.



LEVITOR II MODEL KEY

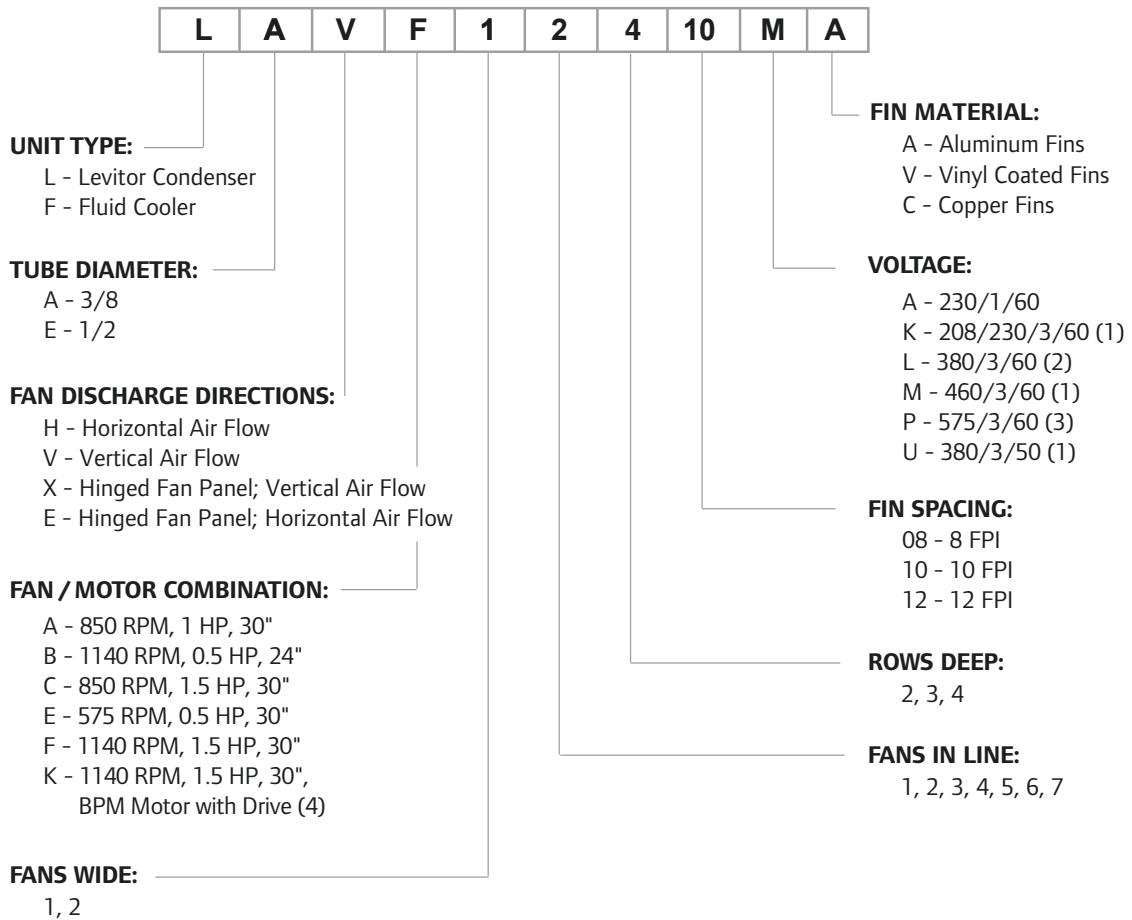

See Tech Bulletin for Title 24 compliant models.

- (1) Inverter suitable motor.
- (2) Contact application engineering for quoting.
- (3) Inverter suitable motor on F and A models.
- (4) BPM motors are 208-230/3/60 or 460/3/60 only.



LEVITOR II AIR-COOLED CONDENSER*Levitor II Models: LAVB - 1.5 HP, 1140 RPM, 24" Fan*

ONE FAN WIDE MODELS	List Price	DIMENSIONS (IN)			SHIP WGT (LBS)
		L	W	H**	
LAVB 11208	\$4,710	39.00	45.75	41.25	178
LAVB 11210	\$4,860	39.00	45.75	41.25	181
LAVB 11212	\$5,110	39.00	45.75	41.25	184
LAVB 11308	\$5,010	39.00	45.75	41.25	180
LAVB 11310	\$5,170	39.00	45.75	41.25	185
LAVB 11312	\$5,430	39.00	45.75	41.25	190
LAVB 11408	\$5,320	39.00	45.75	41.25	193
LAVB 11410	\$5,490	39.00	45.75	41.25	200
LAVB 11412	\$5,770	39.00	45.75	41.25	207
LAVB 12208	\$6,570	75.00	45.75	41.25	346
LAVB 12210	\$6,780	75.00	45.75	41.25	352
LAVB 12212	\$7,120	75.00	45.75	41.25	358
LAVB 12308	\$7,980	75.00	45.75	41.25	362
LAVB 12310	\$8,230	75.00	45.75	41.25	372
LAVB 12312	\$8,640	75.00	45.75	41.25	382
LAVB 12408	\$9,000	75.00	45.75	41.25	386
LAVB 12410	\$9,280	75.00	45.75	41.25	400
LAVB 12412	\$9,740	75.00	45.75	41.25	413
LAVB 13308	\$9,710	111.00	45.75	41.25	544
LAVB 13310	\$10,020	111.00	45.75	41.25	559
LAVB 13312	\$10,510	111.00	45.75	41.25	574
LAVB 13408	\$12,220	111.00	45.75	41.25	580
LAVB 13410	\$12,590	111.00	45.75	41.25	600
LAVB 13412	\$13,230	111.00	45.75	41.25	620
LAVB 14308	\$14,090	147.00	45.75	41.25	820
LAVB 14310	\$14,520	147.00	45.75	41.25	840
LAVB 14312	\$15,260	147.00	45.75	41.25	860
LAVB 14408	\$14,400	147.00	45.75	41.25	873
LAVB 14410	\$14,840	147.00	45.75	41.25	900
LAVB 14412	\$15,590	147.00	45.75	41.25	927
LAVB 15308	\$17,060	183.00	45.75	41.25	836
LAVB 15310	\$17,590	183.00	45.75	41.25	861
LAVB 15312	\$18,470	183.00	45.75	41.25	886
LAVB 15408	\$19,090	183.00	45.75	41.25	917
LAVB 15410	\$19,680	183.00	45.75	41.25	950
LAVB 15412	\$20,660	183.00	45.75	41.25	983
LAVB 16308	\$19,170	219.00	45.75	41.25	1,040
LAVB 16310	\$19,760	219.00	45.75	41.25	1,070
LAVB 16312	\$20,750	219.00	45.75	41.25	1,100
LAVB 16408	\$22,220	219.00	45.75	41.25	1,110
LAVB 16410	\$22,900	219.00	45.75	41.25	1,150
LAVB 16412	\$24,060	219.00	45.75	41.25	1,190
LAVB 17308	\$23,150	262.00	45.75	41.25	1,314
LAVB 17310	\$23,870	262.00	45.75	41.25	1,349
LAVB 17312	\$25,050	262.00	45.75	41.25	1,384
LAVB 17408	\$27,250	262.00	45.75	41.25	1,404
LAVB 17410	\$28,080	262.00	45.75	41.25	1,450
LAVB 17412	\$29,490	262.00	45.75	41.25	1,497

TWO FAN WIDE MODELS	List Price	DIMENSIONS (IN)			SHIP WGT (LBS)
		L	W	H**	
-	-	-	-	-	-
-	-	-	-	-	-
-	-	-	-	-	-
-	-	-	-	-	-
-	-	-	-	-	-
-	-	-	-	-	-
-	-	-	-	-	-
-	-	-	-	-	-
-	-	-	-	-	-
-	-	-	-	-	-
LAVB 22208	\$13,090	75.00	87.63	41.25	642
LAVB 22210	\$13,490	75.00	87.63	41.25	654
LAVB 22212	\$14,160	75.00	87.63	41.25	666
LAVB 22308	\$15,890	75.00	87.63	41.25	845
LAVB 22310	\$16,370	75.00	87.63	41.25	865
LAVB 22312	\$17,190	75.00	87.63	41.25	885
LAVB 22408	\$17,900	75.00	87.63	41.25	895
LAVB 22410	\$18,450	75.00	87.63	41.25	925
LAVB 22412	\$19,380	75.00	87.63	41.25	953
LAVB 23308	\$19,310	111.00	87.63	41.25	1,088
LAVB 23310	\$19,910	111.00	87.63	41.25	1,118
LAVB 23312	\$20,900	111.00	87.63	41.25	1,148
LAVB 23408	\$24,290	111.00	87.63	41.25	1,185
LAVB 23410	\$25,030	111.00	87.63	41.25	1,225
LAVB 23412	\$26,300	111.00	87.63	41.25	1,265
LAVB 24308	\$28,030	147.00	87.63	41.25	1,665
LAVB 24310	\$28,890	147.00	87.63	41.25	1,705
LAVB 24312	\$30,350	147.00	87.63	41.25	1,745
LAVB 24408	\$28,640	147.00	87.63	41.25	1,771
LAVB 24410	\$29,530	147.00	87.63	41.25	1,825
LAVB 24412	\$31,010	147.00	87.63	41.25	1,880
LAVB 25308	\$33,940	183.00	87.63	41.25	1,672
LAVB 25310	\$34,990	183.00	87.63	41.25	1,722
LAVB 25312	\$36,730	183.00	87.63	41.25	1,772
LAVB 25408	\$37,970	183.00	87.63	41.25	1,859
LAVB 25410	\$39,150	183.00	87.63	41.25	1,925
LAVB 25412	\$41,110	183.00	87.63	41.25	1,991
LAVB 26308	\$38,150	219.00	87.63	41.25	2,035
LAVB 26310	\$39,320	219.00	87.63	41.25	2,095
LAVB 26312	\$41,290	219.00	87.63	41.25	2,155
LAVB 26408	\$44,210	219.00	87.63	41.25	2,145
LAVB 26410	\$45,570	219.00	87.63	41.25	2,225
LAVB 26412	\$47,860	219.00	87.63	41.25	2,305
LAVB 27308	\$46,070	255.00	87.63	41.25	2,655
LAVB 27310	\$47,490	255.00	87.63	41.25	2,725
LAVB 27312	\$49,870	255.00	87.63	41.25	2,795
LAVB 27408	\$54,200	255.00	87.63	41.25	2,835
LAVB 27410	\$55,880	255.00	87.63	41.25	2,925
LAVB 27412	\$58,680	255.00	87.63	41.25	3,015

* Height includes 18" legs.

Prices for Horizontal and Vertical air flow are the same with nomenclature changing from "LAVB" to "LAHB".

Prices, product availability, and specifications are subject to change without notice.



LEVITOR II CONDENSER PRODUCT DESCRIPTION

Version: **July 2020**

LEVITOR II AIR-COOLED CONDENSER

Levitor II Models: LAVB Coating and Special Fin Option Pricing (LAVB only)

ONE FAN WIDE MODELS	ElectroFin Coated Coil	Polyester Fin Coating	Copper Fin	TWO FAN WIDE MODELS	ElectroFin Coated Coil	Polyester Fin Coating	Copper Fin
LAVB 11208	\$890	\$720	\$1,730				
LAVB 11210	\$890	\$740	\$1,790				
LAVB 11212	\$890	\$760	\$1,840				
LAVB 11308	\$990	\$790	\$1,830				
LAVB 11310	\$990	\$820	\$1,890				
LAVB 11312	\$990	\$840	\$1,950				
LAVB 11408	\$1,020	\$830	\$1,960				
LAVB 11410	\$1,020	\$850	\$2,020				
LAVB 11412	\$1,020	\$880	\$2,070				
LAVB 12208	\$1,220	\$990	\$2,430	LAVB 22208	\$2,460	\$1,990	\$4,790
LAVB 12210	\$1,220	\$1,020	\$2,500	LAVB 22210	\$2,460	\$2,050	\$4,940
LAVB 12212	\$1,220	\$1,060	\$2,580	LAVB 22212	\$2,460	\$2,110	\$5,090
LAVB 12308	\$1,490	\$1,200	\$2,920	LAVB 22308	\$2,970	\$2,400	\$5,830
LAVB 12310	\$1,490	\$1,240	\$3,020	LAVB 22310	\$2,970	\$2,480	\$6,010
LAVB 12312	\$1,490	\$1,280	\$3,100	LAVB 22312	\$2,970	\$2,550	\$6,190
LAVB 12408	\$1,680	\$1,360	\$3,300	LAVB 22408	\$3,360	\$2,710	\$6,570
LAVB 12410	\$1,680	\$1,400	\$3,400	LAVB 22410	\$3,360	\$2,800	\$6,770
LAVB 12412	\$1,680	\$1,450	\$3,500	LAVB 22412	\$3,360	\$2,880	\$6,980
LAVB 13308	\$1,820	\$1,480	\$3,580	LAVB 23308	\$3,640	\$2,940	\$7,080
LAVB 13310	\$1,820	\$1,520	\$3,680	LAVB 23310	\$3,640	\$3,040	\$7,300
LAVB 13312	\$1,820	\$1,560	\$3,790	LAVB 23312	\$3,640	\$3,120	\$7,520
LAVB 13408	\$2,280	\$1,840	\$4,480	LAVB 23408	\$4,570	\$3,700	\$8,910
LAVB 13410	\$2,280	\$1,900	\$4,620	LAVB 23410	\$4,570	\$3,810	\$9,180
LAVB 13412	\$2,280	\$1,960	\$4,760	LAVB 23412	\$4,570	\$3,930	\$9,460
LAVB 14308	\$2,720	\$2,120	\$5,160	LAVB 24308	\$5,240	\$4,240	\$10,270
LAVB 14310	\$2,720	\$2,180	\$5,310	LAVB 24310	\$5,240	\$4,370	\$10,590
LAVB 14312	\$2,720	\$2,250	\$5,480	LAVB 24312	\$5,240	\$4,510	\$10,910
LAVB 14408	\$2,670	\$2,160	\$5,290	LAVB 24408	\$5,340	\$4,320	\$10,500
LAVB 14410	\$2,670	\$2,230	\$5,450	LAVB 24410	\$5,340	\$4,450	\$10,820
LAVB 14412	\$2,670	\$2,290	\$5,620	LAVB 24412	\$5,340	\$4,590	\$11,150
LAVB 15308	\$3,180	\$2,570	\$6,260	LAVB 25308	\$6,350	\$5,140	\$12,440
LAVB 15310	\$3,180	\$2,650	\$6,450	LAVB 25310	\$6,350	\$5,290	\$12,820
LAVB 15312	\$3,180	\$2,720	\$6,640	LAVB 25312	\$6,350	\$5,460	\$13,210
LAVB 15408	\$3,560	\$2,870	\$7,000	LAVB 25408	\$7,100	\$5,750	\$13,920
LAVB 15410	\$3,560	\$2,960	\$7,210	LAVB 25410	\$7,100	\$5,920	\$14,350
LAVB 15412	\$3,560	\$3,050	\$7,430	LAVB 25412	\$7,100	\$6,100	\$14,780
LAVB 16308	\$3,570	\$2,880	\$7,030	LAVB 26308	\$7,130	\$5,770	\$13,970
LAVB 16310	\$3,570	\$2,970	\$7,250	LAVB 26310	\$7,130	\$5,940	\$14,400
LAVB 16312	\$3,570	\$3,060	\$7,460	LAVB 26312	\$7,130	\$6,120	\$14,840
LAVB 16408	\$4,130	\$3,340	\$8,150	LAVB 26408	\$8,260	\$6,680	\$16,200
LAVB 16410	\$4,130	\$3,440	\$8,400	LAVB 26410	\$8,260	\$6,880	\$16,690
LAVB 16412	\$4,130	\$3,550	\$8,660	LAVB 26412	\$8,260	\$7,090	\$17,200
LAVB 17308	\$4,320	\$3,490	\$8,480	LAVB 27308	\$8,620	\$6,980	\$16,880
LAVB 17310	\$4,320	\$3,600	\$8,740	LAVB 27310	\$8,620	\$7,190	\$17,410
LAVB 17312	\$4,320	\$3,710	\$9,000	LAVB 27312	\$8,620	\$7,410	\$17,930
LAVB 17408	\$5,070	\$4,100	\$10,000	LAVB 27408	\$10,120	\$8,180	\$19,860
LAVB 17410	\$5,070	\$4,220	\$10,300	LAVB 27410	\$10,120	\$8,430	\$20,480
LAVB 17412	\$5,070	\$4,350	\$10,610	LAVB 27412	\$10,120	\$8,700	\$21,090

* Polyester Fin coating is a vinyl coated fin material.

Prices, product availability, and specifications are subject to change without notice.



LEVITOR II CONDENSER PRODUCT DESCRIPTION

Version: **July 2020**

LEVITOR II AIR-COOLED CONDENSER

Levitor II Models: LAV (A, C, E or F) - NOT LAVB or LAVK

ONE FAN WIDE MODEL	List Price	DIMENSIONS (IN)			SHIP WGT (LBS)
		L	W	H**	
LAV* 11208	\$6,470	58.00	45.25	54.00	437
LAV* 11210	\$6,530	58.00	45.25	54.00	439
LAV* 11212	\$6,620	58.00	45.25	54.00	444
LAV* 11308	\$7,000	58.00	45.25	54.00	466
LAV* 11310	\$7,080	58.00	45.25	54.00	469
LAV* 11312	\$7,160	58.00	45.25	54.00	478
LAV* 11408	\$7,250	58.00	45.25	54.00	495
LAV* 11410	\$7,320	58.00	45.25	54.00	499
LAV* 11412	\$7,400	58.00	45.25	54.00	508
LAV* 12208	\$9,200	112.00	45.25	54.00	718
LAV* 12210	\$9,360	112.00	45.25	54.00	721
LAV* 12212	\$9,530	112.00	45.25	54.00	729
LAV* 12308	\$9,850	112.00	45.25	54.00	773
LAV* 12310	\$10,060	112.00	45.25	54.00	779
LAV* 12312	\$10,450	112.00	45.25	54.00	792
LAV* 12408	\$12,290	112.00	45.25	54.00	830
LAV* 12410	\$12,810	112.00	45.25	54.00	838
LAV* 12412	\$13,310	112.00	45.25	54.00	855
LAV* 13210	\$14,040	166.00	45.25	54.00	1,041
LAV* 13212	\$14,360	166.00	45.25	54.00	1,060
LAV* 13308	\$14,680	166.00	45.25	54.00	1,126
LAV* 13310	\$15,000	166.00	45.25	54.00	1,135
LAV* 13312	\$15,510	166.00	45.25	54.00	1,153
LAV* 13408	\$17,480	166.00	45.25	54.00	1,210
LAV* 13410	\$18,180	166.00	45.25	54.00	1,223
LAV* 13412	\$18,910	166.00	45.25	54.00	1,247
LAV* 14308	\$19,680	220.00	45.25	54.00	1,437
LAV* 14310	\$19,850	220.00	45.25	54.00	1,449
LAV* 14312	\$20,640	220.00	45.25	54.00	1,474
LAV* 14408	\$23,310	220.00	45.25	54.00	1,550
LAV* 14410	\$23,900	220.00	45.25	54.00	1,566
LAV* 14412	\$25,160	220.00	45.25	54.00	1,599
LAV* 15308	\$27,960	274.00	45.25	58.50	2,020
LAV* 15310	\$28,360	274.00	45.25	58.50	2,035
LAV* 15312	\$28,770	274.00	45.25	58.50	2,066
LAV* 15408	\$29,150	274.00	45.25	58.50	2,160
LAV* 15410	\$30,380	274.00	45.25	58.50	2,181
LAV* 15412	\$31,610	274.00	45.25	58.50	2,222
LEV* 16308	\$32,790	328.00	45.25	58.50	2,554
LEV* 16310	\$33,270	328.00	45.25	58.50	2,573
LEV* 16312	\$33,760	328.00	45.25	58.50	2,610
LEV* 16408	\$34,240	328.00	45.25	58.50	2,784
LEV* 16410	\$34,740	328.00	45.25	58.50	2,808
LEV* 16412	\$35,200	328.00	45.25	58.50	2,858
LEV* 17308	\$39,040	382.00	45.25	58.50	3,020
LEV* 17310	\$39,610	382.00	45.25	58.50	3,042
LEV* 17312	\$40,160	382.00	45.25	58.50	3,088
LEV* 17408	\$40,720	382.00	45.25	58.50	3,279
LEV* 17410	\$41,300	382.00	45.25	58.50	3,307
LEV* 17412	\$41,880	382.00	45.25	58.50	3,366

TWO FAN WIDE MODEL	List Price	DIMENSIONS (IN)			WGT (LBS)
		L	W	H**	
-	-	-	-	-	-
-	-	-	-	-	-
-	-	-	-	-	-
-	-	-	-	-	-
-	-	-	-	-	-
-	-	-	-	-	-
-	-	-	-	-	-
-	-	-	-	-	-
-	-	-	-	-	-
LAV* 22208	\$18,300	112.00	90.50	54.00	1,311
LAV* 22210	\$18,630	112.00	90.50	54.00	1,320
LAV* 22212	\$18,950	112.00	90.50	54.00	1,336
LAV* 22308	\$19,580	112.00	90.50	54.00	1,437
LAV* 22310	\$19,990	112.00	90.50	54.00	1,425
LAV* 22312	\$20,790	112.00	90.50	54.00	1,462
LAV* 22408	\$24,440	112.00	90.50	54.00	1,539
LAV* 22410	\$25,480	112.00	90.50	54.00	1,555
LAV* 22412	\$26,480	112.00	90.50	54.00	1,588
LAV* 23210	\$27,920	166.00	90.50	54.00	1,875
LAV* 23212	\$28,570	166.00	90.50	54.00	1,912
LAV* 23308	\$29,200	166.00	90.50	54.00	2,044
LAV* 23310	\$29,820	166.00	90.50	54.00	2,063
LAV* 23312	\$30,870	166.00	90.50	54.00	2,100
LAV* 23408	\$35,270	166.00	90.50	54.00	2,214
LAV* 23410	\$36,180	166.00	90.50	54.00	2,238
LAV* 23412	\$37,620	166.00	90.50	54.00	2,287
LAV* 24308	\$39,150	220.00	90.50	54.00	2,526
LAV* 24310	\$39,500	220.00	90.50	54.00	2,651
LAV* 24312	\$41,040	220.00	90.50	54.00	2,700
LAV* 24408	\$46,360	220.00	90.50	54.00	2,851
LAV* 24410	\$47,530	220.00	90.50	54.00	2,884
LAV* 24412	\$50,040	220.00	90.50	54.00	2,950
LAV* 25308	\$55,610	274.00	90.50	58.50	3,725
LAV* 25310	\$56,420	274.00	90.50	58.50	3,755
LAV* 25312	\$57,220	274.00	90.50	58.50	3,817
LAV* 25408	\$58,000	274.00	90.50	58.50	4,005
LAV* 25410	\$60,410	274.00	90.50	58.50	4,046
LAV* 25412	\$62,870	274.00	90.50	58.50	4,129
LEV* 26308	\$65,250	328.00	90.50	58.50	4,759
LEV* 26310	\$66,200	328.00	90.50	58.50	4,796
LEV* 26312	\$67,160	328.00	90.50	58.50	4,870
LEV* 26408	\$68,140	328.00	90.50	58.50	5,218
LEV* 26410	\$69,100	328.00	90.50	58.50	5,268
LEV* 26412	\$70,050	328.00	90.50	58.50	5,366
LEV* 27308	\$76,620	382.00	90.50	58.50	5,757
LEV* 27310	\$77,730	382.00	90.50	58.50	5,794
LEV* 27312	\$79,980	382.00	90.50	58.50	5,868
LEV* 27408	\$81,080	382.00	90.50	58.50	6,216
LEV* 27410	\$82,230	382.00	90.50	58.50	6,266
LEV* 27412	\$83,400	382.00	90.50	58.50	6,364

Prices for Horizontal and Vertical air flow are the same with nomenclature changing from "LAV" to "LAH".

* A,C,E, F or K to specify fan speed and type.

** Height includes 22" legs.

Prices, product availability, and specifications are subject to change without notice.



LEVITOR II CONDENSER PRODUCT DESCRIPTION

Version: July 2020

LEVITOR II AIR-COOLED CONDENSER

Levitor II Models: LAVK / LEVK - 1.5 HP, 1140 RPM, BPM Motor, and Panel Mounted Drive

ONE FAN WIDE MODEL	List Price	DIMENSIONS (IN)			SHIP WGT (LBS)
		L	W	H**	
LAVK 11208	\$8,860	58.00	45.25	54.00	437
LAVK 11210	\$8,940	58.00	45.25	54.00	439
LAVK 11212	\$9,040	58.00	45.25	54.00	444
LAVK 11308	\$9,410	58.00	45.25	54.00	466
LAVK 11310	\$9,500	58.00	45.25	54.00	469
LAVK 11312	\$9,570	58.00	45.25	54.00	478
LAVK 11408	\$9,660	58.00	45.25	54.00	495
LAVK 11410	\$9,730	58.00	45.25	54.00	499
LAVK 11412	\$9,820	58.00	45.25	54.00	508
LAVK 12208	\$13,210	112.00	45.25	54.00	718
LAVK 12210	\$13,360	112.00	45.25	54.00	721
LAVK 12212	\$13,530	112.00	45.25	54.00	729
LAVK 12308	\$13,850	112.00	45.25	54.00	773
LAVK 12310	\$14,060	112.00	45.25	54.00	779
LAVK 12312	\$14,460	112.00	45.25	54.00	792
LAVK 12408	\$16,300	112.00	45.25	54.00	830
LAVK 12410	\$16,820	112.00	45.25	54.00	838
LAVK 12412	\$17,320	112.00	45.25	54.00	855
LAVK 13210	\$19,640	166.00	45.25	54.00	1,041
LAVK 13212	\$19,960	166.00	45.25	54.00	1,060
LAVK 13308	\$20,280	166.00	45.25	54.00	1,126
LAVK 13310	\$20,590	166.00	45.25	54.00	1,135
LAVK 13312	\$21,100	166.00	45.25	54.00	1,153
LAVK 13408	\$23,080	166.00	45.25	54.00	1,210
LAVK 13410	\$23,770	166.00	45.25	54.00	1,223
LAVK 13412	\$24,500	166.00	45.25	54.00	1,247
LAVK 14308	\$27,070	220.00	45.25	54.00	1,437
LAVK 14310	\$27,250	220.00	45.25	54.00	1,449
LAVK 14312	\$28,040	220.00	45.25	54.00	1,474
LAVK 14408	\$30,700	220.00	45.25	54.00	1,550
LAVK 14410	\$31,290	220.00	45.25	54.00	1,566
LAVK 14412	\$32,550	220.00	45.25	54.00	1,599
LAVK 15308	\$37,630	274.00	45.25	58.50	2,020
LAVK 15310	\$38,030	274.00	45.25	58.50	2,035
LAVK 15312	\$38,440	274.00	45.25	58.50	2,066
LAVK 15408	\$38,820	274.00	45.25	58.50	2,160
LAVK 15410	\$40,050	274.00	45.25	58.50	2,181
LAVK 15412	\$41,280	274.00	45.25	58.50	2,222
LEVK 16308	\$44,050	328.00	45.25	58.50	2,554
LEVK 16310	\$44,530	328.00	45.25	58.50	2,573
LEVK 16312	\$45,020	328.00	45.25	58.50	2,610
LEVK 16408	\$45,500	328.00	45.25	58.50	2,784
LEVK 16410	\$46,000	328.00	45.25	58.50	2,808
LEVK 16412	\$46,470	328.00	45.25	58.50	2,858
LEVK 17308	\$51,900	382.00	45.25	58.50	3,020
LEVK 17310	\$52,470	382.00	45.25	58.50	3,042
LEVK 17312	\$53,020	382.00	45.25	58.50	3,088
LEVK 17408	\$53,570	382.00	45.25	58.50	3,279
LEVK 17410	\$54,150	382.00	45.25	58.50	3,307
LEVK 17412	\$54,740	382.00	45.25	58.50	3,366

TWO FAN WIDE MODEL	List Price	DIMENSIONS (IN)			WGT (LBS)
		L	W	H**	
-	-	-	-	-	-
-	-	-	-	-	-
-	-	-	-	-	-
-	-	-	-	-	-
-	-	-	-	-	-
-	-	-	-	-	-
-	-	-	-	-	-
-	-	-	-	-	-
-	-	-	-	-	-
-	-	-	-	-	-
LAVK 22208	\$25,700	112.00	90.50	54.00	1,311
LAVK 22210	\$26,020	112.00	90.50	54.00	1,320
LAVK 22212	\$26,340	112.00	90.50	54.00	1,336
LAVK 22308	\$26,980	112.00	90.50	54.00	1,437
LAVK 22310	\$27,380	112.00	90.50	54.00	1,425
LAVK 22312	\$28,180	112.00	90.50	54.00	1,462
LAVK 22408	\$31,830	112.00	90.50	54.00	1,539
LAVK 22410	\$32,870	112.00	90.50	54.00	1,555
LAVK 22412	\$33,870	112.00	90.50	54.00	1,588
LAVK 23210	\$39,190	166.00	90.50	54.00	1,875
LAVK 23212	\$39,830	166.00	90.50	54.00	1,912
LAVK 23308	\$40,470	166.00	90.50	54.00	2,044
LAVK 23310	\$41,080	166.00	90.50	54.00	2,063
LAVK 23312	\$42,130	166.00	90.50	54.00	2,100
LAVK 23408	\$46,530	166.00	90.50	54.00	2,214
LAVK 23410	\$47,440	166.00	90.50	54.00	2,238
LAVK 23412	\$48,880	166.00	90.50	54.00	2,287
LAVK 24308	\$53,230	220.00	90.50	54.00	2,526
LAVK 24310	\$53,580	220.00	90.50	54.00	2,651
LAVK 24312	\$55,120	220.00	90.50	54.00	2,700
LAVK 24408	\$60,440	220.00	90.50	54.00	2,851
LAVK 24410	\$61,610	220.00	90.50	54.00	2,884
LAVK 24412	\$64,130	220.00	90.50	54.00	2,950
LAVK 25308	\$72,500	274.00	90.50	58.50	3,725
LAVK 25310	\$73,310	274.00	90.50	58.50	3,755
LAVK 25312	\$74,110	274.00	90.50	58.50	3,817
LAVK 25408	\$74,890	274.00	90.50	58.50	4,005
LAVK 25410	\$77,300	274.00	90.50	58.50	4,046
LAVK 25412	\$79,760	274.00	90.50	58.50	4,129
LEVK 26308	\$84,950	328.00	90.50	58.50	4,759
LEVK 26310	\$85,890	328.00	90.50	58.50	4,796
LEVK 26312	\$86,860	328.00	90.50	58.50	4,870
LEVK 26408	\$87,840	328.00	90.50	58.50	5,218
LEVK 26410	\$88,800	328.00	90.50	58.50	5,268
LEVK 26412	\$89,750	328.00	90.50	58.50	5,366
LEVK 27308	\$99,120	382.00	90.50	58.50	5,757
LEVK 27310	\$100,240	382.00	90.50	58.50	5,794
LEVK 27312	\$102,480	382.00	90.50	58.50	5,868
LEVK 27408	\$103,580	382.00	90.50	58.50	6,216
LEVK 27410	\$104,740	382.00	90.50	58.50	6,266
LEVK 27412	\$105,900	382.00	90.50	58.50	6,364

Prices for Horizontal and Vertical air flow are the same with nomenclature changing from "LAV" to "LAH".

** Height includes 22" legs.

Prices, product availability, and specifications are subject to change without notice.



LEVITOR II CONTROL PANEL NOMENCLATURE

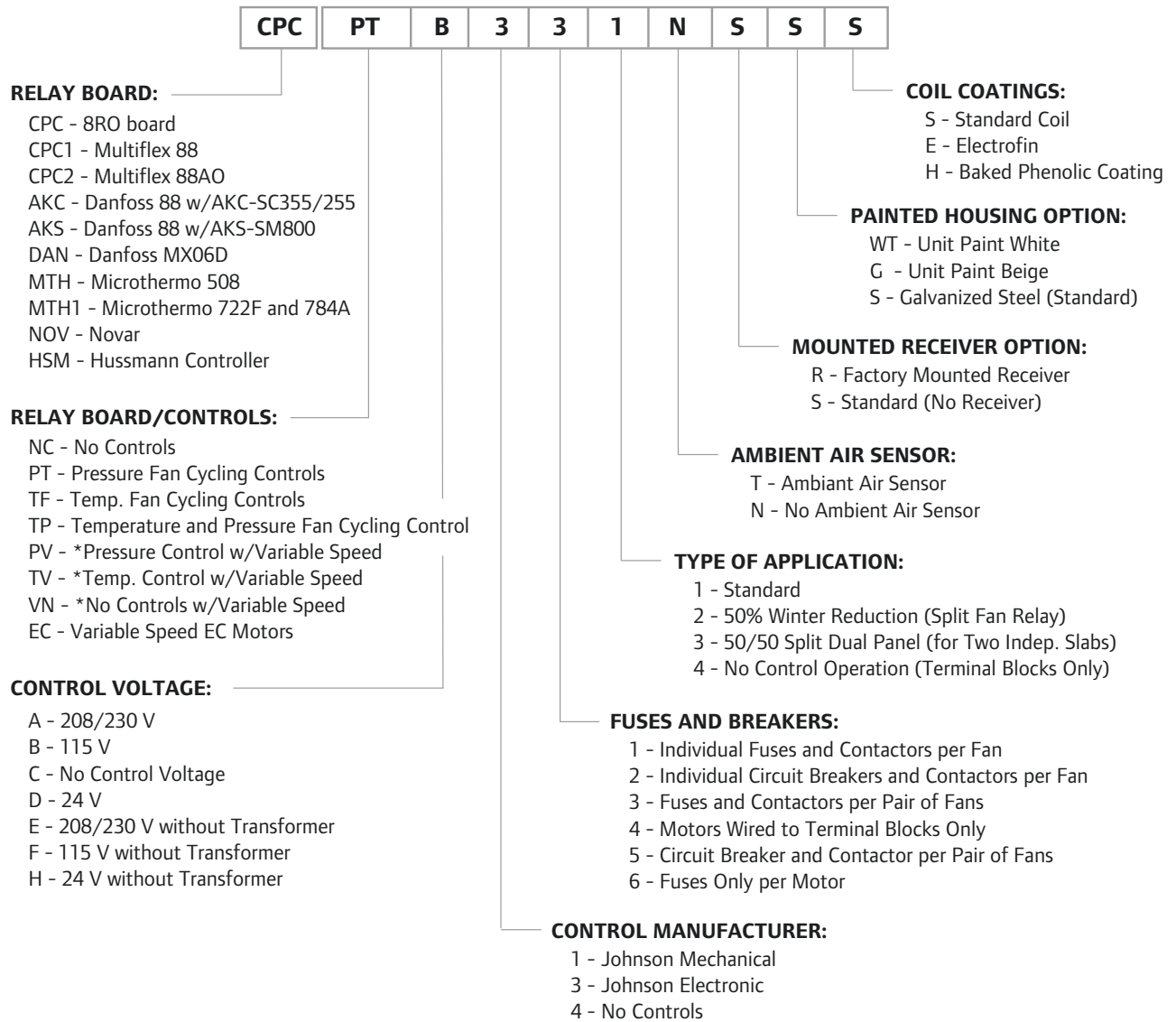

* Variable Speed fan at header with 208-230/1 drive requires separate power feed or transformer if main power is not 208-230/3/60.



LEVITOR II CONDENSER PRODUCT DESCRIPTION

Version: **July 2020**

LEVITOR II AIR-COOLED CONDENSER OPTIONS

Levitor II Leg Options: LAV (A, C, E, F or K Models) - Except LAVB

FAN CONFIGURATION	DEDUCT FOR NO LEGS	15" LEGS	22" LEGS	30" LEGS	36" LEGS	42" LEGS	48" LEGS	60" LEGS
1 x 1	(\$80)	N/C	STD	\$190	\$190	\$190	\$1,370	\$1,990
1 x 2	(\$80)	N/C	STD	\$190	\$190	\$190	\$2,060	\$2,980
1 x 3	(\$120)	N/C	STD	\$280	\$280	\$280	\$2,750	\$3,980
1 x 4	(\$120)	N/C	STD	\$280	\$280	\$280	\$3,430	\$4,970
1 x 5	(\$120)	N/C	STD	\$370	\$370	\$370	\$4,120	\$5,960
1 x 6	(\$160)	N/C	STD	\$370	\$370	\$370	\$4,800	\$6,950
1 x 7	(\$200)	N/C	STD	\$470	\$470	\$470	\$5,490	\$7,950
2 x 2	(\$80)	N/C	STD	\$190	\$190	\$190	\$2,060	\$2,960
2 x 3	(\$160)	N/C	STD	\$370	\$370	\$370	\$2,750	\$3,950
2 x 4	(\$120)	N/C	STD	\$280	\$280	\$280	\$3,430	\$4,940
2 x 5	(\$160)	N/C	STD	\$370	\$370	\$370	\$4,120	\$5,930
2 x 6	(\$160)	N/C	STD	\$370	\$370	\$370	\$4,800	\$6,920
2 x 7	(\$200)	N/C	STD	\$470	\$470	\$470	\$5,490	\$7,900

48" legs include gussets.

60" legs include gussets and cross bracing.

FAN CONFIGURATION	HINGED FAN PANEL	GRAVITY DAMPERS	PAINTED HOUSING
1 x 1	\$370	\$720	\$940
1 x 2	\$740	\$1,440	\$1,880
1 x 3	\$1,110	\$2,160	\$2,820
1 x 4	\$1,480	\$2,880	\$3,760
1 x 5	\$1,850	\$3,600	\$4,700
1 x 6	\$2,220	\$4,320	\$5,640
1 x 7	\$2,590	\$5,040	\$6,580
2 x 2	\$1,480	\$2,880	\$3,620
2 x 3	\$2,220	\$4,320	\$5,430
2 x 4	\$2,960	\$5,760	\$7,240
2 x 5	\$3,700	\$7,200	\$9,050
2 x 6	\$4,440	\$8,640	\$10,860
2 x 7	\$5,180	\$10,080	\$12,670

Gravity Dampers are NOT available on horizontal Air Throw Units.

Prices, product availability, and specifications are subject to change without notice.



LEVITOR II CONDENSER PRODUCT DESCRIPTION

Version: **July 2020**

LEVITOR II CONTROL PANELS

* The heading of each column is the fan controls and the last 3 numbers in the Control Panel Nomenclature

FAN CONFIGURATION	TF, PT, TP *311	TF, PT, TP *331	NC *411	NC *431	NC *461
1 x 1	\$1,240	-	\$950	-	\$630
1 x 2	\$1,770	-	\$1,200	-	\$830
1 x 3	\$2,270	-	\$1,270	-	\$840
1 x 4	\$2,790	-	\$1,640	-	\$1,150
1 x 5	\$3,280	-	\$1,870	-	\$1,310
1 x 6	\$3,750	-	\$2,070	-	\$1,460
1 x 7	\$4,240	-	\$2,270	-	\$1,590
2 x 2	\$2,680	\$1,900	\$2,130	\$1,330	\$1,630
2 x 3	\$3,580	\$2,410	\$2,740	\$1,570	\$2,120
2 x 4	\$4,450	\$2,900	\$3,340	\$1,800	\$2,590
2 x 5	\$5,310	\$3,410	\$3,890	\$2,020	\$3,020
2 x 6	\$6,150	\$3,890	\$4,470	\$2,200	\$3,470
2 x 7	\$7,000	\$4,360	\$5,030	\$2,410	\$3,920

CONTROL DESCRIPTION

Model 311

Individual Fuses and Contactors, plus Fan Cycling Controls

Model 331

Fuses and Contactors per Pair of Fans, plus Fan Cycle Controls

Model 411

No Fan Cycle Controls, Individual Fuses and Contactors

Model 431

No Fan Cycle Controls, Fuses and Contactors per Pair of Fans

Model 412

No Fan Cycle Controls, Fuses and Contactors per Fan, Winter Reduction Relay

Model 413

No Fan Cycle Controls, Fuses and Contactors per Fan
50/50 split control panel

Model 461

No Fan Cycle Controls
Individual Fuses
(Use with Vspeed - LAVK)

Options	Add \$
50/50 Split (2x Only) For Independent Slab Operation	Two 1 x Panels
50% Winter Reduction Relay (2x Only)	\$280
Phase Loss Monitor	\$1,050
Circuit Breakers: Per Breaker	\$430
NEMA Contactor: Per Contactor	\$370
Mounted Non-Fused Disconnect	\$1,770
Mounted Fused Disconnect (60 amp or less)	\$1,970
VFD Power Distribution Block	\$620
115 Volt GFI Outlet (not wired)	\$1,020
115 Volt GFI Outlet (wired with transformer)	\$1,730
** PV, TV, VN, Variable Speed (1x Only) (Plus Control Panel)	\$1,500
** PV, TV, VN, Variable Speed (2x Only) (Plus Control Panel)	\$2,520
Control Circuit 10 amp Disconnect	\$320
Drop Leg Transducer Tap with Pressure Transducer	\$1,530
Drop Leg Pressure Transducer Tap ONLY	\$310
Rochester Liquid Level Guage W/ Alarm contact	\$2,800
Rupture Disc Assembly	\$1,220
RELAY BOARDS	
CPC 8RO RELAY BOARD	\$2,590
CPC1 MULTIFLEX 88 BOARD	\$3,090
CPC2 MULTIFLEX 88AO BOARD	\$3,480
AKC - DANFOSS 88 BOARD & COMM - AK-SC355/255	\$2,590
AKS - DANFOSS 88 BOARD & COMM - AKS-SM800	\$2,590
DAN - DANFOSS MX06D W TRANSDUCER & TEMP SENSOR	\$2,520
MTH - MICRO THERMO MT-508	\$2,590
MTH1 - MICRO THERMO MT-722F/784A	\$4,240
NOV - Novar #7330130	\$2,590
HSM - Hussmann controller with transducer and temperature sensor	\$2,180
Ambient Air Sensor - CPC , DANFOSS, NOVAR	\$330
Danfoss BP5 Ambient Temp Sensor w/ enclosure	\$610

INVERTER DUTY SUITABLE MOTORS ARE NOW STANDARD ON LEVITOR SERIES ON 208-230/3/60, 460/3/60 and 575/3/60 WITH "F" 1140 RPM and "A" 850 RPM 1 HP MOTORS

** When Selecting PV, TV, VN option, must add additional corresponding control panel(s).
This is a variable speed, header end fan only. All other fans will be the standard.

*** Controller model required to provide correct com module.

Prices, product availability, and specifications are subject to change without notice.



LEVITOR II CONDENSER PRODUCT DESCRIPTION

Version: July 2020

LEVITOR II AIR-COOLED CONDENSER OPTIONS

Levitor II Models: LAV (A, C, E, F or K Models) Coil Coating and Special Fin Options - Except LAVB

Single Wide Model	ElectroFin Coated Coil	Polyester Fin Coating *	Copper Fin	Double Wide Model	ElectroFin Coated Coil	Polyester Fin Coating *	Copper Fin
11208	\$1,090	\$890	\$2,380	-	-	-	-
11210	\$1,090	\$900	\$2,400	-	-	-	-
11212	\$1,090	\$920	\$2,430	-	-	-	-
11308	\$1,190	\$980	\$2,570	-	-	-	-
11310	\$1,190	\$990	\$2,600	-	-	-	-
11312	\$1,190	\$1,000	\$2,630	-	-	-	-
11408	\$1,220	\$1,010	\$2,660	-	-	-	-
11410	\$1,220	\$1,020	\$2,690	-	-	-	-
11412	\$1,220	\$1,030	\$2,720	-	-	-	-
12208	\$1,550	\$1,270	\$3,380	22208	\$3,100	\$2,540	\$6,720
12210	\$1,550	\$1,290	\$3,440	22210	\$3,100	\$2,580	\$6,820
12212	\$1,550	\$1,310	\$3,490	22212	\$3,100	\$2,630	\$6,950
12308	\$1,670	\$1,360	\$3,610	22308	\$3,330	\$2,740	\$7,180
12310	\$1,670	\$1,390	\$3,690	22310	\$3,330	\$2,780	\$7,330
12312	\$1,670	\$1,450	\$3,840	22312	\$3,330	\$2,880	\$7,620
12408	\$2,130	\$1,680	\$4,510	22408	\$4,270	\$3,380	\$8,960
12410	\$2,130	\$1,780	\$4,700	22410	\$4,270	\$3,560	\$9,340
12412	\$2,130	\$1,840	\$4,890	22412	\$4,270	\$3,680	\$9,700
13210	\$2,320	\$1,930	\$5,160	23210	\$4,660	\$3,880	\$10,220
13212	\$2,320	\$1,980	\$5,260	23212	\$4,660	\$3,960	\$10,470
13308	\$2,480	\$2,030	\$5,400	23308	\$4,950	\$4,050	\$10,710
13310	\$2,480	\$2,070	\$5,500	23310	\$4,950	\$4,130	\$10,940
13312	\$2,480	\$2,140	\$5,680	23312	\$4,950	\$4,280	\$11,320
13408	\$3,010	\$2,410	\$6,410	23408	\$6,020	\$4,830	\$12,920
13410	\$3,010	\$2,510	\$6,680	23410	\$6,020	\$5,010	\$13,260
13412	\$3,010	\$2,600	\$6,940	23412	\$6,020	\$5,210	\$13,790
14308	\$3,280	\$2,710	\$7,210	24308	\$6,560	\$5,430	\$14,350
14310	\$3,280	\$2,740	\$7,290	24310	\$6,560	\$5,470	\$14,480
14312	\$3,280	\$2,840	\$7,570	24312	\$6,560	\$5,680	\$15,050
14408	\$3,960	\$3,200	\$8,540	24408	\$7,900	\$6,420	\$16,980
14410	\$3,960	\$3,300	\$8,760	24410	\$7,900	\$6,580	\$17,420
14412	\$3,960	\$3,460	\$9,220	24412	\$7,900	\$6,940	\$18,350
15308	\$4,690	\$3,860	\$10,240	25308	\$9,370	\$7,710	\$20,380
15310	\$4,690	\$3,910	\$10,400	25310	\$9,370	\$7,810	\$20,680
15312	\$4,690	\$3,960	\$10,550	25312	\$9,370	\$7,920	\$20,970
15408	\$5,020	\$4,010	\$10,690	25408	\$10,020	\$8,030	\$21,250
15410	\$5,020	\$4,180	\$11,130	25410	\$10,020	\$8,350	\$22,140
15412	\$5,020	\$4,350	\$11,590	25412	\$10,020	\$8,690	\$23,050
16308	\$5,500	\$4,510	\$12,020	26308	\$11,010	\$9,020	\$23,910
16310	\$5,500	\$4,590	\$12,200	26310	\$11,010	\$9,170	\$24,260
16312	\$5,500	\$4,650	\$12,380	26312	\$11,010	\$9,300	\$24,610
16408	\$5,750	\$4,710	\$12,550	26408	\$11,490	\$9,430	\$24,970
16410	\$5,750	\$4,790	\$12,720	26410	\$11,490	\$9,580	\$25,310
16412	\$5,750	\$4,850	\$12,900	26412	\$11,490	\$9,690	\$25,660
17308	\$6,190	\$5,160	\$13,800	27308	\$12,640	\$10,330	\$27,440
17310	\$6,190	\$5,270	\$14,000	27310	\$12,640	\$10,530	\$27,840
17312	\$6,190	\$5,340	\$14,210	27312	\$12,640	\$10,680	\$28,250
17408	\$6,480	\$5,410	\$14,410	27408	\$12,980	\$10,830	\$28,690
17410	\$6,480	\$5,400	\$14,310	27410	\$12,980	\$10,810	\$28,480
17412	\$6,480	\$5,350	\$14,210	27412	\$12,980	\$10,690	\$28,270

* Polyester fin coating is a vinyl-coated-fin material.

Prices, product availability, and specifications are subject to change without notice.



LEVITOR II CONDENSER PRODUCT DESCRIPTION

Version: July 2020

LEVITOR II AIR-COOLED CONDENSER RECEIVER OPTIONS

CONDENSER WITH FACTORY MOUNTED RECEIVER:

Includes ORI / ORD flooding valve, isolation ball valves, gauge type liquid level indicator and dual relief valve.

LEVITOR II MODEL	Size	MOUNTED RECEIVER WITH BASE FRAME	RECEIVER SIZE	RECEIVER HEAT TAPE & INSULATION	RECEIVER INSULATION ONLY	BASE FRAME ONLY
LAVB 24" FAN MODEL 1 RECEIVER	1x1	\$5,490	10.75" x 48"	\$1,370		
	1x2	\$6,640	10.75" x 60"	\$1,760		
	1x3	\$7,320	10.75" x 60"	\$1,760		
	1x4	\$8,380	10.75" x 60"	\$1,920		
	1x5	\$11,140	10.75" x 60"	\$2,100		
	1x6	\$12,200	10.75" x 60"	\$2,100		
	1x7	\$13,000	12.75" x 72"	\$2,100		
LAVB 24" FAN MODEL 1 RECEIVER	2x2	\$8,990	(1) 10.75" x 60"	\$1,910		
	2x3	\$9,910	(1) 10.75" x 60"	\$1,910		
	2x4	\$11,900	(1) 12.75" x 72"	\$2,190		
	2x5	\$15,080	(1) 12.75" x 72"	\$2,190		
	2x6	\$16,460	(1) 12.75" x 72"	\$2,340		
	2x7	\$18,510	(1) 12.75" x 72"	\$2,340		
LAVB 24" FAN MODEL 2 RECEIVERS FOR INDEPENDENT SLAB OPERATION	2x2	\$11,930	(2) 10.75" x 60"	\$3,430		
	2x3	\$13,170	(2) 10.75" x 60"	\$3,430		
	2x4	\$15,080	(2) 10.75" x 60"	\$3,840		
	2x5	\$20,020	(2) 10.75" x 60"	\$3,840		
	2x6	\$21,930	(2) 10.75" x 60"	\$4,200		
	2x7	\$23,310	(2) 12.75" x 72"	\$4,200		
L_V() 30" FAN MODEL 1 RECEIVER	1x1	\$8,230	10.75" x 60"	\$1,370		\$830
	1x2	\$8,700	10.75" x 60"	\$1,920		\$1,270
	1x3	\$10,460	10.75" x 60"	\$1,920		\$1,800
	1x4	\$12,200	10.75" x 60"	\$2,100		\$2,220
	1x5	\$13,950	12.75" x 72"	\$2,270		\$2,750
	1x6	\$15,690	12.75" x 72"	\$2,440		\$3,170
	1x7	\$17,360	12.75" x 72"	\$2,620		\$3,700
L_V() 30" FAN MODEL 1 RECEIVER	2x2	\$13,410	(1) 10.75" x 60"	\$2,100		\$1,210
	2x3	\$15,080	(1) 12.75" x 72"	\$2,270		\$1,990
	2x4	\$16,740	(1) 12.75" x 72"	\$2,270		\$2,410
	2x5	\$18,530	(1) 12.75" x 72"	\$2,440		\$2,950
	2x6	\$20,210	(1) 12.75" x 72"	\$2,630		\$3,380
	2x7	\$21,870	(1) 12.75" x 72"	\$2,820		\$4,020
	L_V() 30" FAN MODEL 2 RECEIVERS FOR INDEPENDENT SLAB OPERATION	2x2	\$15,690	(2) 10.75" x 60"	\$3,480	
2x3		\$19,170	(2) 10.75" x 60"	\$3,840		
2x4		\$22,660	(2) 10.75" x 60"	\$4,200		
2x5		\$26,150	(2) 12.75" x 72"	\$4,540		
2x6		\$29,630	(2) 12.75" x 72"	\$4,890		
2x7		\$33,110	(2) 12.75" x 72"	\$5,230		

_ A or E () A, C, E, F or K

RECEIVER OPTIONS			RECEIVER CAPACITIES			
FROM RECEIVER SIZE	TO RECEIVER SIZE		CAPACITY 80% FULL (LBS)	R-404A	R-407A/F/C	R-448A/449A
10.75" x 48"	10.75" x 60"	\$400	10.75" X 48"	111	118	115
10.75" x 60"	12.75" x 72"	\$740	10.75" X 60"	140	149	145
12.75" x 72"	14.75" x 96"	\$1,190	12.75" X 72"	239	254	248
10.75" x 60"	14.75" x 96"	\$1,910	14.75" X 96"	386	410	400
Add to receiver and base frame List Price above.						
		DEDUCT \$				
10.75" x 60"	10.75" x 48"	(\$400)				
12.75" x 72"	10.75" x 60"	(\$740)				
12.75" x 72"	10.75" x 48"	(\$1,140)				
Deduct From receiver and base frame List Price above.						
14.75" X 96 HEAT AND INSULATION		\$4,200				
Drop Leg Pressure Transducer w/ Tap		\$1,530				
Drop Leg Pressure Transducer Tap ONLY		\$310				
Rochester liquid level guage w/ alarm contact		\$2,800				
Rupture Disc Assembly		\$1,220				



MX - MICROCHANNEL MODEL KEY

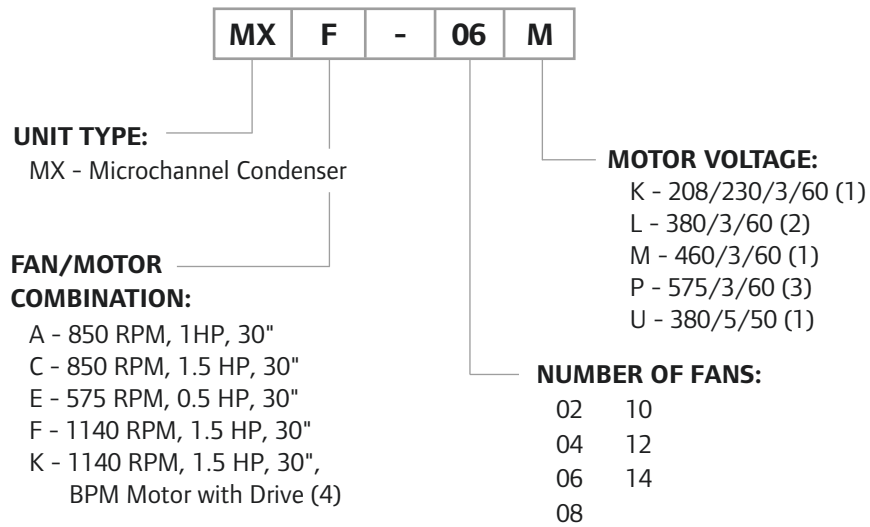

- (1) Invertor suitable motor.
- (2) Contact application engineering for quoting.
- (3) Invertor suitable motor on F and A models.
- (4) BPM motors are 208-230/3/60 or 460/3/60 only.



MICROCHANNEL PRODUCT DESCRIPTION

Version: July 2020

MX - MICROCHANNEL AIR-COOLED CONDENSER

MODEL	List Price	THR in MBH (000) @ 10° F TD R-404A	AIR FLOW (CFM)	DIMENSIONS (IN)			SHIP WGT. (LBS)	SUMMER R-404A (LBS)	WINTER R-404A LBS @ -20 F
				L	W	H*			
1/2 HP, 575 RPM*									
MXE-02	\$14,900	98.8	12,600	44.00	90.25	42.00	560	4	12
MXE-04	\$27,150	197.5	25,200	88.00	90.25	42.00	1,170	15	26
MXE-06	\$41,820	296.3	37,800	132.00	90.25	42.00	1,705	23	40
MXE-08	\$53,620	395.0	50,400	176.00	90.25	42.00	2,280	40	55
MXE-10	\$68,360	493.8	63,000	220.00	90.25	42.00	2,850	52	70
MXE-12	\$85,870	592.5	75,600	264.00	90.25	42.00	3,385	80	88
MXE-14	\$103,390	691.3	88,200	308.00	90.25	42.00	3,920	108	106
1 HP, 850 RPM									
MXA-02	\$14,900	145.2	20,800	44.00	90.25	42.00	560	4	12
MXA-04	\$27,150	290.3	41,600	88.00	90.25	42.00	1,170	15	26
MXA-06	\$41,820	435.5	62,400	132.00	90.25	42.00	1,705	23	40
MXA-08	\$53,620	580.7	83,200	176.00	90.25	42.00	2,280	40	55
MXA-10	\$68,360	725.8	104,000	220.00	90.25	42.00	2,850	52	70
MXA-12	\$85,870	871.0	124,800	264.00	90.25	42.00	3,385	80	88
MXA-14	\$103,390	1,016.2	145,600	308.00	90.25	42.00	3,920	108	106
1 1/2 HP, 850 RPM									
MXC-02	\$14,900	151.8	22,830	44.00	90.25	42.00	560	4	12
MXC-04	\$27,150	303.5	45,660	88.00	90.25	42.00	1,170	15	26
MXC-06	\$41,820	455.3	68,490	132.00	90.25	42.00	1,705	23	40
MXC-08	\$53,620	607.1	91,320	176.00	90.25	42.00	2,280	40	55
MXC-10	\$68,360	758.8	114,150	220.00	90.25	42.00	2,850	52	70
MXC-12	\$85,870	910.6	136,980	264.00	90.25	42.00	3,385	80	88
MXC-14	\$103,390	1,062.4	159,010	308.00	90.25	42.00	3,920	108	106
1 1/2 HP, 1140 RPM									
MXF-02	\$14,900	154.5	25,600	44.00	90.25	42.00	560	4	12
MXF-04	\$27,150	308.9	51,200	88.00	90.25	42.00	1,170	15	26
MXF-06	\$41,820	463.4	76,800	132.00	90.25	42.00	1,705	23	40
MXF-08	\$53,620	617.8	102,400	176.00	90.25	42.00	2,280	40	55
MXF-10	\$68,360	772.3	128,000	220.00	90.25	42.00	2,850	52	70
MXF-12	\$85,870	926.7	153,600	264.00	90.25	42.00	3,385	80	88
MXF-14	\$103,390	1,081.2	179,200	308.00	90.25	42.00	3,920	108	106
1 1/2 HP, 1140 RPM, BPM Motor and Panel Mounted Drive									
MXK-02	\$18,910	154.5	25,600	44.00	90.25	42.00	560	4	12
MXK-04	\$34,550	308.9	51,200	88.00	90.25	42.00	1,170	15	26
MXK-06	\$53,080	463.4	76,800	132.00	90.25	42.00	1,705	23	40
MXK-08	\$67,700	617.8	102,400	176.00	90.25	42.00	2,280	40	55
MXK-10	\$85,250	772.3	128,000	220.00	90.25	42.00	2,850	52	70
MXK-12	\$105,570	926.7	153,600	264.00	90.25	42.00	3,385	80	88
MXK-14	\$125,890	1,081.2	179,200	308.00	90.25	42.00	3,920	108	106

Notes:

- MX Microchannel are a 2 fan modular design.
- MXA, MXC, MXF, and MXE include Inverter Duty Suitable Fan Motors (not available on 575/3/60 volt units).
- MXK includes BPM (brushless permanent magnet) motor and panel mounted drive.
- 22" Legs are standard on Microchannel without a receiver.
- Add 22" to height when ship loose; legs are required.
- Add 18" to height for mounted receiver.
- Winter Flooding charge does not reflect module isolation valves.

Prices, product availability, and specifications are subject to change without notice.



MX - MICROCHANNEL CONTROL PANEL NOMENCLATURE

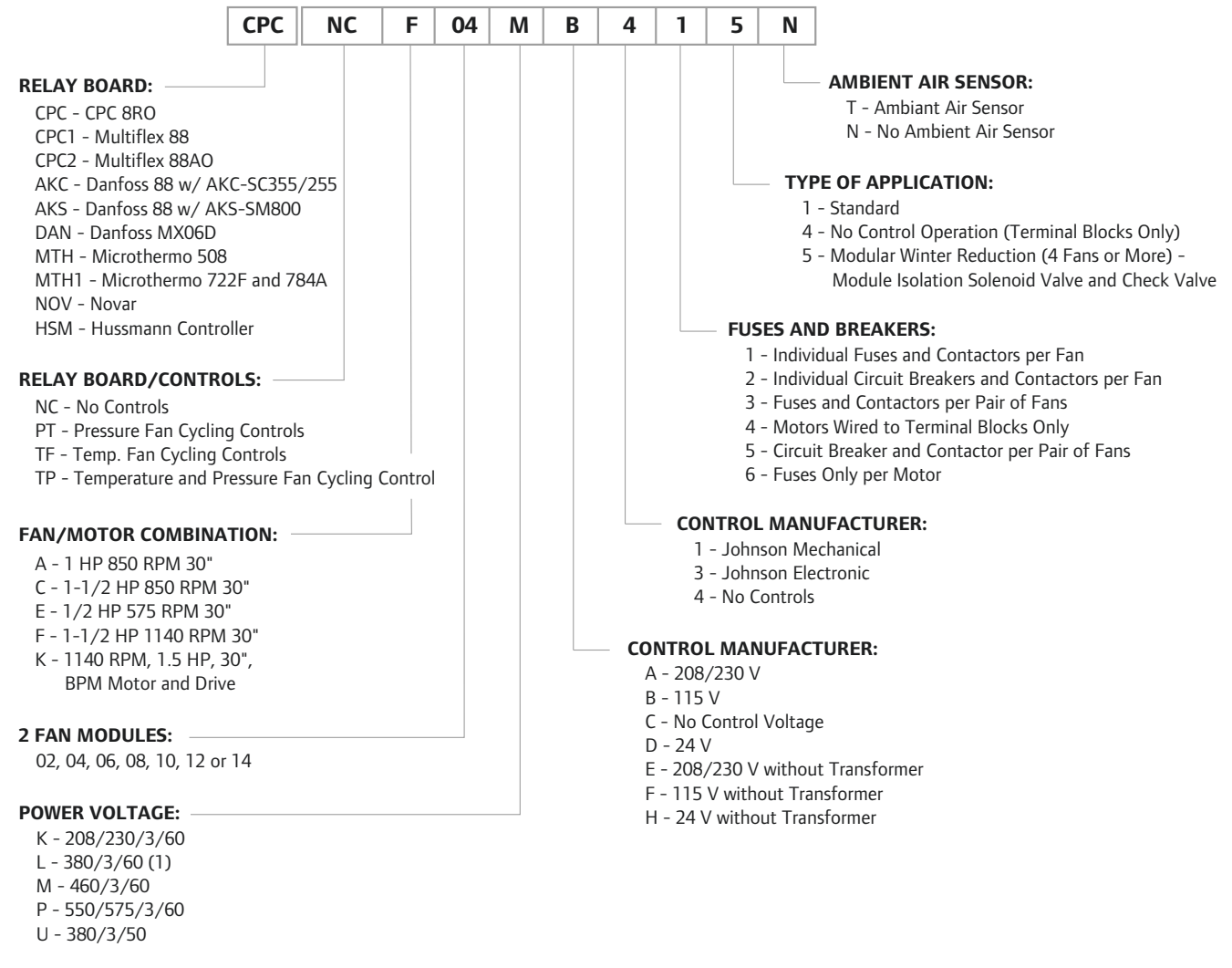

(1) Contact application engineering for quoting.



MX - MICROCHANNEL CONTROL PANEL

MX* Model	TF, PT, TP 311	TF, PT, TP 331	NC 411	NC 431	NC 461	TF,PT,TP 315	TF,PT,TP 335	NC 415	NC 435	NC 445	NC 465
MX* 02	\$1,770	-	\$1,200	\$950	\$830	-	-	-	-	-	-
MX* 04	\$2,680	\$1,900	\$2,130	\$1,330	\$1,630	\$3,800	\$3,030	\$3,260	\$2,450	\$1,120	\$2,760
MX* 06	\$3,580	\$2,410	\$2,740	\$1,570	\$2,120	\$5,810	\$4,650	\$4,970	\$3,810	\$2,240	\$4,350
MX* 08	\$4,450	\$2,900	\$3,340	\$1,800	\$2,590	\$7,810	\$6,260	\$6,700	\$5,160	\$3,360	\$5,950
MX* 10	\$5,310	\$3,410	\$3,890	\$2,020	\$3,020	\$9,800	\$7,890	\$8,360	\$6,490	\$4,480	\$7,490
MX* 12	\$6,150	\$3,890	\$4,470	\$2,200	\$3,470	\$11,740	\$9,480	\$10,070	\$7,800	\$5,600	\$9,070
MX* 14	\$6,990	\$4,370	\$5,030	\$2,410	\$3,920	\$13,710	\$11,090	\$11,750	\$9,130	\$6,720	\$10,640

* A , E , C , F or K NOTE: The heading of each column is the last 3 numbers in the Control Panel Nomenclature.

CONTROL DESCRIPTION

Model 311

Individual Fuses and Contactors, plus Fan Cycling

Model 331

Fuses and Contactors per Pair of Fans, plus Fan Cycle Controls

Model 411

No Fan Cycle Controls, Individual Fuses and Contactors

Model 431

No Fan Cycle Controls, Fuses and Contactors per Pair of Fans

Model 461

No Fan Cycle Controls, Individual Fuses (Use with Vspeed MXK)

Model 315

Individual Fuses and Contactors, plus Fan Cycle Winter Isolation Solenoid Valve(s)

Model 335

Fuses and Contactors per Pair of Fans, plus Fan Cycling Controls Winter Isolation Solenoid Valve(s)

Model 415

Individual Fuses and Contactors Winter Isolation Solenoid Valve(s)

Model 435

Fuses and Contactors per Pair of Fans, Winter Isolation Solenoid Valve(s)

Model 444 (Std.)

Motors wired to terminal blocks

Model 445

Motors wired to terminal blocks plus Winter Isolation Solenoid Valve(s)

Model 465

Individual Fuses Winter Isolation Solenoid Valve(s)

CONTROL OPTIONS

Phase Loss Monitor	\$1,050
Circuit Breakers: Per Breaker	\$430
NEMA Contactor: Per Contactor	\$370
Mounted Non-Fused Disconnect	\$1,770
Mounted Fused Disconnect (60 amp or less)	\$1,970
VFD Power Distribution Block (use when control transformer is located in condenser control panel)	\$620
115 Volt GFI Outlet (not wired)	\$1,020
Drop Leg Transducer Tap with Pressure Transducer	\$1,530
Drop Leg Pressure Transducer Tap ONLY	\$310
Rochester liquid level guage w/ alarm contact	\$2,800
Rupture Disc Assembly	\$4,190
RELAY BOARDS	
CPC 8RO RELAY BOARD	\$2,590
CPC1 MULTIFLEX 88 BOARD	\$3,090
CPC2 MULTIFLEX 88AO BOARD	\$3,480
AKC - DANFOSS 88 BOARD & COMM - AK-SC355/255	\$2,590
AKS - DANFOSS 88 BOARD & COMM - AKS-SM800	\$2,590
DAN - DANFOSS MX06D W TRANSDUCER & TEMP SENSOR	\$2,520
MTH - MICRO THERMO MT-508	\$2,590
MTH1 - MICRO THERMO MT-722F/784A	\$4,240
NOV - Novar #7330130	\$2,590
HSM - Hussmann controller with transducer and temperature sensor	\$2,180
Ambient Air Sensor - CPC , DANFOSS, NOVAR	\$330
Danfoss BP5 Ambient Temp Sensor w/ enclosure	\$610

Notes:

INVERTER DUTY SUITABLE MOTORS ARE STANDARD ON MX (A, C, E, or F) WITH 208-230/3/60 AND 460/3/60.

575/3/60 INVERTER DUTY STANDARD ON MXA AND MXF.

WINTER ISOLATION VALVES INCLUDE SOLENOID AND CHECK VALVE. WINTER ISOLATION SOLENOID VALVE NOT PROVIDED ON LEAD MODULE.



MICROCHANNEL PRODUCT DESCRIPTION

Version: July 2020

MX - MICROCHANNEL AIR COOLED CONDENSER OPTIONS

Condenser with Factory Mounted Receiver:

Includes ORI / ORD flooding valve, isolation ball valve, gauge type liquid level indicator and dual relief valve.

MICRO CHANNEL	Model	MOUNTED RECEIVER	RECEIVER SIZE	HEAT AND INSULATION	INSULATION ONLY
MX* 1 RECEIVER	MX*-02	\$12,490	(1) 10.750" x 60"	\$2,030	
	MX*-04	\$13,410	(1) 10.750" x 60"	\$2,030	
	MX*-06	\$15,080	(1) 12.750" x 72"	\$2,190	
	MX*-08	\$16,740	(1) 12.750" x 72"	\$2,190	
	MX*-10	\$18,530	(1) 12.750" x 72"	\$2,360	
	MX*-12	\$20,210	(1) 12.750" x 72"	\$2,540	
MX* 2 RECEIVERS	MX*-14	\$21,870	(1) 12.750" x 72"	\$2,540	
	MX*-06	\$19,170	(2) 10.750" x 60"	\$3,710	
	MX*-08	\$22,660	(2) 10.750" x 60"	\$4,060	
	MX*-10	\$26,150	(2) 12.750" x 72"	\$4,390	
	MX*-12	\$29,630	(2) 12.750" x 72"	\$4,720	
	MX*-14	\$33,120	(2) 12.750" x 72"	\$4,720	

* A, C, E, F or K

RECEIVER OPTIONS

FROM RECEIVER SIZE	TO RECEIVER SIZE	ADD \$	RECEIVER	R404a LBS @ 80% FULL)	R407A/F LBS @ 80% FULL	R448A/449A LBS @ 80% FULL)
10.75" x 48"	10.75" x 60"	\$400	10.75" X 48"	111	118	115
10.75" x 60"	12.75" x 72"	\$740	10.75" X 60"	140	149	145
12.75" x 72"	14.75" x 96"	\$1,190	12.75" X 72"	239	254	248
10.75" x 60"	14.75" x 96"	\$1,910	14.75" X 96"	386	410	400

Add to Receiver and Base Frame List Price above.

		DEDUCT \$
10.75" x 60"	10.75" x 48"	(\$400)
12.75" x 72"	10.75" x 60"	(\$740)
12.75" x 72"	10.75" x 48"	(\$1,140)

Deduct From receiver and base frame List Price above.

14.75" X 96 HEAT AND INSULATION	\$4,200
Drop Leg Transducer Tap with Pressure Transducer	\$1,530
Drop Leg Pressure Transducer Tap ONLY	\$310
Rochester Liquid Level Gauge with Alarm Contact	\$2,800
Rupture Disc Assembly	\$1,220

Model	ELECTRO FIN COATED COIL	** MODULE ISOLATION BALL VALVES	*** CLEANABLE COIL FILTER P/N E410114001	42"LEGS
MX*-02	\$3,300	\$1,400	\$3,470	\$190
MX*-04	\$6,600	\$2,800	\$6,940	\$190
MX*-06	\$9,900	\$4,200	\$10,410	\$190
MX*-08	\$13,200	\$5,600	\$13,880	\$380
MX*-10	\$16,500	\$7,000	\$17,350	\$380
MX*-12	\$19,800	\$8,400	\$20,820	\$380
MX*-14	\$23,100	\$9,800	\$24,290	\$475

** ISOLATION BALL VALVES PER MODULE ISOLATES THE ENTIRE MODULE.

*** CLEANABLE AIR FILTER PER MODULE IN A "V" SHAPE.

MICROCHANNEL WITH A FACTORY MOUNTED RECEIVER SHIPS WITH NO LEGS STANDARD.

LEVITOR II / FLUID COOLER MODEL KEY

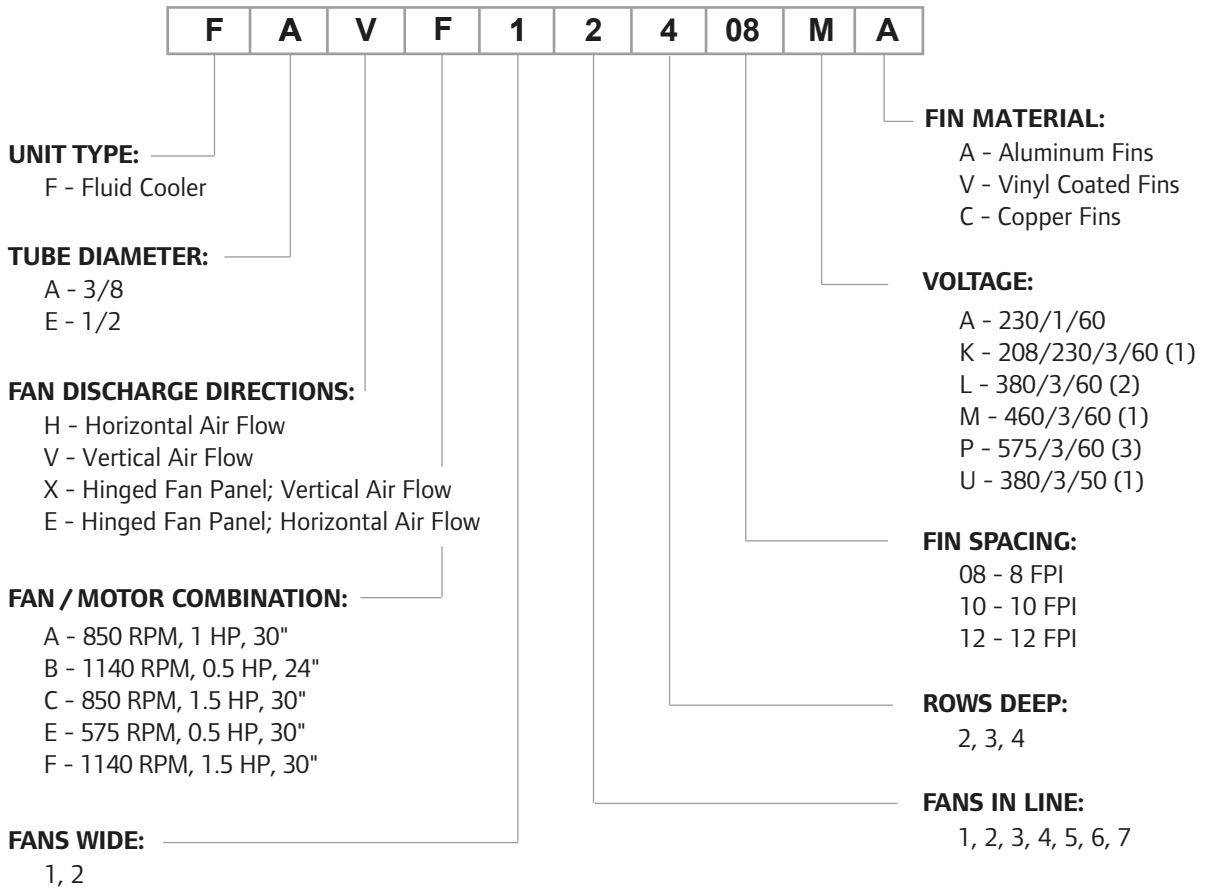

- (1) Invertor suitable motor.
- (2) Contact application engineering for quoting.
- (3) Invertor suitable motor on F and A models.

Prices, product availability, and specifications are subject to change without notice.



LEVITOR II / FLUID COOLER PRODUCT DESCRIPTION

Version: **July 2020**

LEVITOR II FLUID COOLER

Levitor II Fluid Cooler Models: FAVB - 1.5 HP, 1140 RPM, 24" Fan

ONE FAN WIDE MODELS	List Price	DIMENSIONS (IN)			APPROX SHIP WGT (LBS)
		L	W	H **	
FAVB 11208	\$4,710	39.00	45.75	41.25	178
FAVB 11210	\$4,860	39.00	45.75	41.25	181
FAVB 11212	\$5,110	39.00	45.75	41.25	184
FAVB 11308	\$5,010	39.00	45.75	41.25	180
FAVB 11310	\$5,170	39.00	45.75	41.25	185
FAVB 11312	\$5,430	39.00	45.75	41.25	190
FAVB 11408	\$5,320	39.00	45.75	41.25	193
FAVB 11410	\$5,490	39.00	45.75	41.25	200
FAVB 11412	\$5,770	39.00	45.75	41.25	207
FAVB 12208	\$6,570	75.00	45.75	41.25	346
FAVB 12210	\$6,780	75.00	45.75	41.25	352
FAVB 12212	\$7,120	75.00	45.75	41.25	358
FAVB 12308	\$7,980	75.00	45.75	41.25	362
FAVB 12310	\$8,230	75.00	45.75	41.25	372
FAVB 12312	\$8,640	75.00	45.75	41.25	382
FAVB 12408	\$9,000	75.00	45.75	41.25	386
FAVB 12410	\$9,280	75.00	45.75	41.25	400
FAVB 12412	\$9,740	75.00	45.75	41.25	413
FAVB 13308	\$9,710	111.00	45.75	41.25	544
FAVB 13310	\$10,020	111.00	45.75	41.25	559
FAVB 13312	\$10,510	111.00	45.75	41.25	574
FAVB 13408	\$12,220	111.00	45.75	41.25	580
FAVB 13410	\$12,590	111.00	45.75	41.25	600
FAVB 13412	\$13,230	111.00	45.75	41.25	620
FAVB 14308	\$14,090	147.00	45.75	41.25	820
FAVB 14310	\$14,520	147.00	45.75	41.25	840
FAVB 14312	\$15,260	147.00	45.75	41.25	860
FAVB 14408	\$14,400	147.00	45.75	41.25	873
FAVB 14410	\$14,840	147.00	45.75	41.25	900
FAVB 14412	\$15,590	147.00	45.75	41.25	927
FAVB 15308	\$17,060	183.00	45.75	41.25	836
FAVB 15310	\$17,590	183.00	45.75	41.25	861
FAVB 15312	\$18,470	183.00	45.75	41.25	886
FAVB 15408	\$19,090	183.00	45.75	41.25	917
FAVB 15410	\$19,680	183.00	45.75	41.25	950
FAVB 15412	\$20,660	183.00	45.75	41.25	983
FAVB 16308	\$19,170	219.00	45.75	41.25	1,040
FAVB 16310	\$19,760	219.00	45.75	41.25	1,070
FAVB 16312	\$20,750	219.00	45.75	41.25	1,100
FAVB 16408	\$22,220	219.00	45.75	41.25	1,110
FAVB 16410	\$22,900	219.00	45.75	41.25	1,150
FAVB 16412	\$24,060	219.00	45.75	41.25	1,190
FAVB 17308	\$23,150	262.00	45.75	41.25	1,314
FAVB 17310	\$23,870	262.00	45.75	41.25	1,349
FAVB 17312	\$25,050	262.00	45.75	41.25	1,384
FAVB 17408	\$27,250	262.00	45.75	41.25	1,404
FAVB 17410	\$28,080	262.00	45.75	41.25	1,450
FAVB 17412	\$29,490	262.00	45.75	41.25	1,497

TWO FAN WIDE MODELS	List Price	DIMENSIONS (IN)			APPROX SHIP WGT (LBS)
		L	W	H **	
-	-	-	-	-	-
-	-	-	-	-	-
-	-	-	-	-	-
-	-	-	-	-	-
-	-	-	-	-	-
-	-	-	-	-	-
-	-	-	-	-	-
-	-	-	-	-	-
-	-	-	-	-	-
-	-	-	-	-	-
FAVB 22208	\$13,090	75.00	87.63	41.25	642
FAVB 22210	\$13,490	75.00	87.63	41.25	654
FAVB 22212	\$14,160	75.00	87.63	41.25	666
FAVB 22308	\$15,890	75.00	87.63	41.25	845
FAVB 22310	\$16,370	75.00	87.63	41.25	865
FAVB 22312	\$17,190	75.00	87.63	41.25	885
FAVB 22408	\$17,900	75.00	87.63	41.25	895
FAVB 22410	\$18,450	75.00	87.63	41.25	925
FAVB 22412	\$19,380	75.00	87.63	41.25	953
FAVB 23308	\$19,310	111.00	87.63	41.25	1,088
FAVB 23310	\$19,910	111.00	87.63	41.25	1,118
FAVB 23312	\$20,900	111.00	87.63	41.25	1,148
FAVB 23408	\$24,290	111.00	87.63	41.25	1,185
FAVB 23410	\$25,030	111.00	87.63	41.25	1,225
FAVB 23412	\$26,300	111.00	87.63	41.25	1,265
FAVB 24308	\$28,030	147.00	87.63	41.25	1,665
FAVB 24310	\$28,890	147.00	87.63	41.25	1,705
FAVB 24312	\$30,350	147.00	87.63	41.25	1,745
FAVB 24408	\$28,640	147.00	87.63	41.25	1,771
FAVB 24410	\$29,530	147.00	87.63	41.25	1,825
FAVB 24412	\$31,010	147.00	87.63	41.25	1,880
FAVB 25308	\$33,940	183.00	87.63	41.25	1,672
FAVB 25310	\$34,990	183.00	87.63	41.25	1,722
FAVB 25312	\$36,730	183.00	87.63	41.25	1,772
FAVB 25408	\$37,970	183.00	87.63	41.25	1,859
FAVB 25410	\$39,150	183.00	87.63	41.25	1,925
FAVB 25412	\$41,110	183.00	87.63	41.25	1,991
FAVB 26308	\$38,150	219.00	87.63	41.25	2,035
FAVB 26310	\$39,320	219.00	87.63	41.25	2,095
FAVB 26312	\$41,290	219.00	87.63	41.25	2,155
FAVB 26408	\$44,210	219.00	87.63	41.25	2,145
FAVB 26410	\$45,570	219.00	87.63	41.25	2,225
FAVB 26412	\$47,860	219.00	87.63	41.25	2,305
FAVB 27308	\$46,070	255.00	87.63	41.25	2,655
FAVB 27310	\$47,490	255.00	87.63	41.25	2,725
FAVB 27312	\$49,870	255.00	87.63	41.25	2,795
FAVB 27408	\$54,200	255.00	87.63	41.25	2,835
FAVB 27410	\$55,880	255.00	87.63	41.25	2,925
FAVB 27412	\$58,680	255.00	87.63	41.25	3,015

** Height includes 18" legs.

Prices for Horizontal and Vertical air flow are the same. Substitute "H" for "V" in the model number.

Prices, product availability, and specifications are subject to change without notice.



LEVITOR II FLUID COOLER

Levitor II Fluid Cooler Models: FAVB Coating and Special Fin Option Pricing - 1.5 HP, 1140 RPM, 24" Fan ONLY

ONE FAN WIDE MODEL	ElectroFin Coated Coil	Polyester Fin Coating	Copper Fin	TWO FAN WIDE MODEL	ElectroFin Coated Coil	Polyester Fin Coating	Copper Fin
FAVB-11210	\$890	\$740	\$1,790	-	-	-	-
FAVB-11310	\$990	\$790	\$1,890	-	-	-	-
FAVB-11410	\$1,020	\$850	\$2,020	-	-	-	-
FAVB-12210	\$1,220	\$1,020	\$2,500	FAVB-22210	\$2,460	\$2,050	\$4,940
FAVB-12310	\$1,490	\$1,240	\$3,020	FAVB-22310	\$2,970	\$2,480	\$6,010
FAVB-12410	\$1,680	\$1,400	\$3,400	FAVB-22410	\$3,360	\$2,800	\$6,770
FAVB-13310	\$1,820	\$1,520	\$3,680	FAVB-23310	\$3,640	\$3,040	\$7,300
FAVB-13410	\$2,280	\$1,900	\$4,620	FAVB-23410	\$4,570	\$3,810	\$9,180
FAVB-14310	\$2,720	\$2,180	\$5,310	FAVB-24310	\$5,240	\$4,370	\$10,590
FAVB-14410	\$2,670	\$2,230	\$5,450	FAVB-24410	\$5,340	\$4,450	\$10,820
FAVB-15310	\$3,180	\$2,650	\$6,450	FAVB-25310	\$6,350	\$5,290	\$12,820
FAVB-15410	\$3,560	\$2,960	\$7,210	FAVB-25410	\$7,100	\$5,920	\$14,350
FAVB-16310	\$3,570	\$2,970	\$7,250	FAVB-26310	\$7,130	\$5,940	\$14,400
FAVB-16410	\$4,130	\$3,440	\$8,400	FAVB-26410	\$8,260	\$6,880	\$16,690
FAVB-17310	\$4,320	\$3,600	\$8,740	FAVB-27310	\$8,620	\$7,190	\$17,410
FAVB-17410	\$5,070	\$4,220	\$10,300	FAVB-27410	\$10,120	\$8,430	\$20,480

** Polyester fin coating is a vinyl-coated fin material.*

Prices for Horizontal and Vertical air flow are the same.



LEVITOR II FLUID COOLER MODELS

Levitor II Fluid Cooler Models: LEVA, LEVC, LEVE, LEVF MODELS - Except LEVB

SINGLE FAN WIDE MODEL	List Price	DIMENSIONS (IN)			APPROX SHIP WGT (LBS)	TWO FAN WIDE MODELS	List Price	DIMENSIONS (IN)			APPROX SHIP WGT (LBS)
		L	W	H**				L	W	H**	
FEV* 11208	\$6,580	58.00	45.25	54.00	437	-	-	-	-	-	-
FEV* 11210	\$6,670	58.00	45.25	54.00	439	-	-	-	-	-	-
FEV* 11212	\$6,750	58.00	45.25	54.00	444	-	-	-	-	-	-
FEV* 11308	\$7,130	58.00	45.25	54.00	466	-	-	-	-	-	-
FEV* 11310	\$7,200	58.00	45.25	54.00	469	-	-	-	-	-	-
FEV* 11312	\$7,300	58.00	45.25	54.00	478	-	-	-	-	-	-
FEV* 11408	\$7,370	58.00	45.25	54.00	495	-	-	-	-	-	-
FEV* 11410	\$7,450	58.00	45.25	54.00	499	-	-	-	-	-	-
FEV* 11412	\$7,550	58.00	45.25	54.00	508	-	-	-	-	-	-
FEV* 12208	\$9,370	112.00	45.25	54.00	718	FEV* 22208	\$18,640	112.00	90.50	54.00	1,311
FEV* 12210	\$9,540	112.00	45.25	54.00	721	FEV* 22210	\$18,960	112.00	90.50	54.00	1,320
FEV* 12212	\$9,700	112.00	45.25	54.00	729	FEV* 22212	\$19,290	112.00	90.50	54.00	1,336
FEV* 12308	\$10,030	112.00	45.25	54.00	773	FEV* 22308	\$19,940	112.00	90.50	54.00	1,437
FEV* 12310	\$10,230	112.00	45.25	54.00	779	FEV* 22310	\$20,360	112.00	90.50	54.00	1,425
FEV* 12312	\$10,640	112.00	45.25	54.00	792	FEV* 22312	\$21,150	112.00	90.50	54.00	1,462
FEV* 12408	\$12,530	112.00	45.25	54.00	830	FEV* 22408	\$24,910	112.00	90.50	54.00	1,539
FEV* 12410	\$13,040	112.00	45.25	54.00	838	FEV* 22410	\$25,940	112.00	90.50	54.00	1,555
FEV* 12412	\$13,560	112.00	45.25	54.00	855	FEV* 22412	\$26,970	112.00	90.50	54.00	1,588
FEV* 13210	\$14,290	166.00	45.25	54.00	1,041	FEV* 23210	\$28,430	166.00	90.50	54.00	1,875
FEV* 13212	\$14,620	166.00	45.25	54.00	1,060	FEV* 23212	\$29,100	166.00	90.50	54.00	1,912
FEV* 13308	\$14,960	166.00	45.25	54.00	1,126	FEV* 23308	\$29,750	166.00	90.50	54.00	2,044
FEV* 13310	\$15,280	166.00	45.25	54.00	1,135	FEV* 23310	\$30,380	166.00	90.50	54.00	2,063
FEV* 13312	\$15,810	166.00	45.25	54.00	1,153	FEV* 23312	\$31,440	166.00	90.50	54.00	2,100
FEV* 13408	\$17,790	166.00	45.25	54.00	1,210	FEV* 23408	\$35,920	166.00	90.50	54.00	2,214
FEV* 13410	\$18,520	166.00	45.25	54.00	1,223	FEV* 23410	\$36,840	166.00	90.50	54.00	2,238
FEV* 13412	\$19,260	166.00	45.25	54.00	1,247	FEV* 23412	\$38,320	166.00	90.50	54.00	2,287
FEV* 14308	\$20,040	220.00	45.25	54.00	1,437	FEV* 24308	\$39,870	220.00	90.50	54.00	2,526
FEV* 14310	\$20,230	220.00	45.25	54.00	1,449	FEV* 24310	\$40,240	220.00	90.50	54.00	2,651
FEV* 14312	\$21,010	220.00	45.25	54.00	1,474	FEV* 24312	\$41,810	220.00	90.50	54.00	2,700
FEV* 14408	\$23,730	220.00	45.25	54.00	1,550	FEV* 24408	\$47,230	220.00	90.50	54.00	2,851
FEV* 14410	\$24,330	220.00	45.25	54.00	1,566	FEV* 24410	\$48,400	220.00	90.50	54.00	2,884
FEV* 14412	\$25,630	220.00	45.25	54.00	1,599	FEV* 24412	\$50,980	220.00	90.50	54.00	2,950
FEV* 15308	\$28,490	274.00	45.25	58.50	2,020	FEV* 25308	\$56,640	274.00	90.50	58.50	3,725
FEV* 15310	\$28,890	274.00	45.25	58.50	2,035	FEV* 25310	\$57,470	274.00	90.50	58.50	3,755
FEV* 15312	\$29,300	274.00	45.25	58.50	2,066	FEV* 25312	\$58,270	274.00	90.50	58.50	3,817
FEV* 15408	\$29,670	274.00	45.25	58.50	2,160	FEV* 25408	\$59,070	274.00	90.50	58.50	4,005
FEV* 15410	\$30,930	274.00	45.25	58.50	2,181	FEV* 25410	\$61,550	274.00	90.50	58.50	4,046
FEV* 15412	\$32,190	274.00	45.25	58.50	2,222	FEV* 25412	\$64,040	274.00	90.50	58.50	4,129
FEV* 16308	\$32,790	328.00	45.25	58.50	2,554	FEV* 26308	\$65,250	328.00	90.50	58.50	4,759
FEV* 16310	\$33,270	328.00	45.25	58.50	2,573	FEV* 26310	\$66,200	328.00	90.50	58.50	4,796
FEV* 16312	\$33,760	328.00	45.25	58.50	2,610	FEV* 26312	\$67,160	328.00	90.50	58.50	4,870
FEV* 16408	\$34,240	328.00	45.25	58.50	2,784	FEV* 26408	\$68,140	328.00	90.50	58.50	5,218
FEV* 16410	\$34,740	328.00	45.25	58.50	2,808	FEV* 26410	\$69,100	328.00	90.50	58.50	5,268
FEV* 16412	\$35,200	328.00	45.25	58.50	2,858	FEV* 26412	\$70,050	328.00	90.50	58.50	5,366
FEV* 17308	\$39,040	382.00	45.25	58.50	3,020	FEV* 27308	\$76,620	382.00	90.50	58.50	5,757
FEV* 17310	\$39,610	382.00	45.25	58.50	3,042	FEV* 27310	\$77,730	382.00	90.50	58.50	5,794
FEV* 17312	\$40,160	382.00	45.25	58.50	3,088	FEV* 27312	\$79,980	382.00	90.50	58.50	5,868
FEV* 17408	\$40,720	382.00	45.25	58.50	3,279	FEV* 27408	\$81,080	382.00	90.50	58.50	6,216
FEV* 17410	\$41,300	382.00	45.25	58.50	3,307	FEV* 27410	\$82,230	382.00	90.50	58.50	6,266
FEV* 17412	\$41,880	382.00	45.25	58.50	3,366	FEV* 27412	\$83,400	382.00	90.50	58.50	6,364

* A,C,E,F TO SPECIFY FANS AS A = 1 HP 850RPM, C = 1-1/2 HP 850RPM, E = 1/2HP 575RPM, and F = 1-1/2HP 1140RPM FANS

** Height includes 22" legs.



LEVITOR II FLUID COOLER MODELS

Levitor II Fluid Cooler Models: FEVE, FEVA, FEVF, FEVC (Except FAVB) Coil Coating and Special Fin Option Pricing

ONE FAN WIDE MODELS	Internal Volume	DIMENSIONS (IN)			SHIP WGT	ElectroFin Coating	Polyester Coating	TWO FAN WIDE MODELS	Internal Volume	DIMENSIONS (IN)			SHIP WGT	ElectroFin Coating	Polyester Coating
		L	W	H						L	W	H			
11208	3.5	58.00	45.25	54.00	447	\$1,190	\$980	-	-	-	-	-	-	-	
11210	3.6	58.00	45.25	54.00	449	\$1,190	\$990	-	-	-	-	-	-	-	
11212	3.7	58.00	45.25	54.00	454	\$1,190	\$1,000	-	-	-	-	-	-	-	
11308	5.0	58.00	45.25	54.00	481	\$1,300	\$1,060	-	-	-	-	-	-	-	
11310	5.2	58.00	45.25	54.00	484	\$1,300	\$1,080	-	-	-	-	-	-	-	
11312	5.3	58.00	45.25	54.00	493	\$1,300	\$1,100	-	-	-	-	-	-	-	
11408	6.5	58.00	45.25	54.00	515	\$1,350	\$1,110	-	-	-	-	-	-	-	
11410	6.7	58.00	45.25	54.00	519	\$1,350	\$1,120	-	-	-	-	-	-	-	
11412	6.9	58.00	45.25	54.00	528	\$1,350	\$1,130	-	-	-	-	-	-	-	
12208	6.4	112.00	45.25	54.00	738	\$1,700	\$1,390	22208	12.4	112.00	90.50	54.00	1,351	\$3,370	\$2,770
12210	6.5	112.00	45.25	54.00	741	\$1,700	\$1,410	22210	12.6	112.00	90.50	54.00	1,360	\$3,370	\$2,810
12212	6.6	112.00	45.25	54.00	749	\$1,700	\$1,440	22212	12.8	112.00	90.50	54.00	1,376	\$3,370	\$2,840
12308	9.5	112.00	45.25	54.00	803	\$1,820	\$1,500	22308	18.7	112.00	90.50	54.00	1,497	\$3,620	\$2,950
12310	9.6	112.00	45.25	54.00	809	\$1,820	\$1,520	22310	18.9	112.00	90.50	54.00	1,485	\$3,620	\$3,020
12312	9.7	112.00	45.25	54.00	822	\$1,820	\$1,570	22312	19.1	112.00	90.50	54.00	1,522	\$3,620	\$3,140
12408	16.4	112.00	45.25	54.00	870	\$2,320	\$1,840	22408	24.8	112.00	90.50	54.00	1,619	\$4,590	\$3,680
12410	16.5	112.00	45.25	54.00	878	\$2,320	\$1,930	22410	25.0	112.00	90.50	54.00	1,635	\$4,590	\$3,830
12412	16.6	112.00	45.25	54.00	895	\$2,320	\$2,020	22412	25.3	112.00	90.50	54.00	1,668	\$4,590	\$3,980
13208	9.4	166.00	45.25	54.00	1,050	\$2,550	\$2,090	23208	18.3	166.00	90.50	54.00	1,920	\$5,040	\$4,240
13210	9.5	166.00	45.25	54.00	1,071	\$2,550	\$2,120	23210	18.5	166.00	90.50	54.00	1,935	\$5,040	\$4,200
13212	9.6	166.00	45.25	54.00	1,090	\$2,550	\$2,160	23212	18.7	166.00	90.50	54.00	1,972	\$5,040	\$4,300
13308	13.7	166.00	45.25	54.00	1,156	\$2,710	\$2,200	23308	27.4	166.00	90.50	54.00	2,134	\$5,380	\$4,390
13310	13.9	166.00	45.25	54.00	1,180	\$2,710	\$2,260	23310	27.7	166.00	90.50	54.00	2,153	\$5,380	\$4,480
13312	14.1	166.00	45.25	54.00	1,198	\$2,710	\$2,340	23312	27.9	166.00	90.50	54.00	2,190	\$5,380	\$4,640
13408	18.3	166.00	45.25	54.00	1,255	\$3,280	\$2,640	23408	36.7	166.00	90.50	54.00	2,331	\$6,540	\$5,290
13410	18.5	166.00	45.25	54.00	1,283	\$3,280	\$2,740	23410	36.9	166.00	90.50	54.00	2,355	\$6,540	\$5,450
13412	18.7	166.00	45.25	54.00	1,307	\$3,280	\$2,840	23412	37.1	166.00	90.50	54.00	2,404	\$6,540	\$5,650
14308	18.2	220.00	45.25	54.00	1,497	\$3,580	\$2,960	24308	36.3	220.00	90.50	54.00	2,641	\$7,110	\$5,890
14310	18.4	220.00	45.25	54.00	1,509	\$3,580	\$2,980	24310	36.5	220.00	90.50	54.00	2,766	\$7,110	\$5,930
14312	18.6	220.00	45.25	54.00	1,534	\$3,580	\$3,100	24312	36.7	220.00	90.50	54.00	2,815	\$7,110	\$6,170
14408	24.0	220.00	45.25	54.00	1,610	\$4,320	\$3,490	24408	48.4	220.00	90.50	54.00	3,004	\$8,570	\$6,960
14410	24.3	220.00	45.25	54.00	1,643	\$4,320	\$3,600	24410	48.6	220.00	90.50	54.00	3,037	\$8,570	\$7,140
14412	24.6	220.00	45.25	54.00	1,676	\$4,320	\$3,790	24412	48.8	220.00	90.50	54.00	3,103	\$8,570	\$7,520
15308	22.5	274.00	45.25	58.50	2,097	\$5,120	\$4,210	25308	45.2	274.00	90.50	58.50	3,868	\$10,170	\$8,350
15310	22.7	274.00	45.25	58.50	2,106	\$5,120	\$4,260	25310	45.4	274.00	90.50	58.50	3,898	\$10,170	\$8,480
15312	22.9	274.00	45.25	58.50	2,137	\$5,120	\$4,330	25312	45.6	274.00	90.50	58.50	3,960	\$10,170	\$8,690
15408	30.2	274.00	45.25	58.50	2,231	\$5,480	\$4,380	25408	60.3	274.00	90.50	58.50	4,195	\$10,900	\$8,700
15410	30.3	274.00	45.25	58.50	2,276	\$5,480	\$4,570	25410	60.5	274.00	90.50	58.50	4,236	\$10,900	\$9,080
15412	30.5	274.00	45.25	58.50	2,317	\$5,480	\$4,740	25412	60.7	274.00	90.50	58.50	4,319	\$10,900	\$9,440
16308	27.0	328.00	45.25	58.50	2,649	\$6,000	\$4,930	26308	54.2	328.00	90.50	58.50	4,759	\$11,920	\$9,810
16310	27.2	328.00	45.25	58.50	2,573	\$6,000	\$5,000	26310	54.4	328.00	90.50	58.50	4,796	\$11,920	\$9,930
16312	27.4	328.00	45.25	58.50	2,610	\$6,000	\$5,090	26312	54.6	328.00	90.50	58.50	4,870	\$11,920	\$10,090
16408	35.7	328.00	45.25	58.50	2,784	\$6,280	\$5,150	26408	72.1	328.00	90.50	58.50	5,218	\$12,440	\$10,230
16410	36.0	328.00	45.25	58.50	2,808	\$6,280	\$5,230	26410	72.3	328.00	90.50	58.50	5,268	\$12,440	\$10,370
16412	36.4	328.00	45.25	58.50	2,858	\$6,280	\$5,280	26412	72.5	328.00	90.50	58.50	5,366	\$12,440	\$10,510
17308	31.5	382.00	45.25	58.50	3,020	\$6,890	\$5,710	27308	63.2	382.00	90.50	58.50	5,757	\$13,670	\$11,260
17310	31.7	382.00	45.25	58.50	3,042	\$6,890	\$5,740	27310	63.4	382.00	90.50	58.50	5,794	\$13,670	\$11,390
17312	31.9	382.00	45.25	58.50	3,088	\$6,890	\$5,840	27312	63.6	382.00	90.50	58.50	5,868	\$13,670	\$11,540
17408	41.2	382.00	45.25	58.50	3,279	\$7,080	\$5,840	27408	83.9	382.00	90.50	58.50	6,216	\$14,190	\$11,690
17410	41.7	382.00	45.25	58.50	3,307	\$7,080	\$5,900	27410	84.1	382.00	90.50	58.50	6,266	\$14,190	\$11,820
17412	42.3	382.00	45.25	58.50	3,366	\$7,080	\$5,940	27412	84.3	382.00	90.50	58.50	6,364	\$14,190	\$11,970

* Polyester fin coating is a vinyl-coated fin material.

Prices, product availability, and specifications are subject to change without notice.



FLUID COOLER CONTROL PANEL NOMENCLATURE

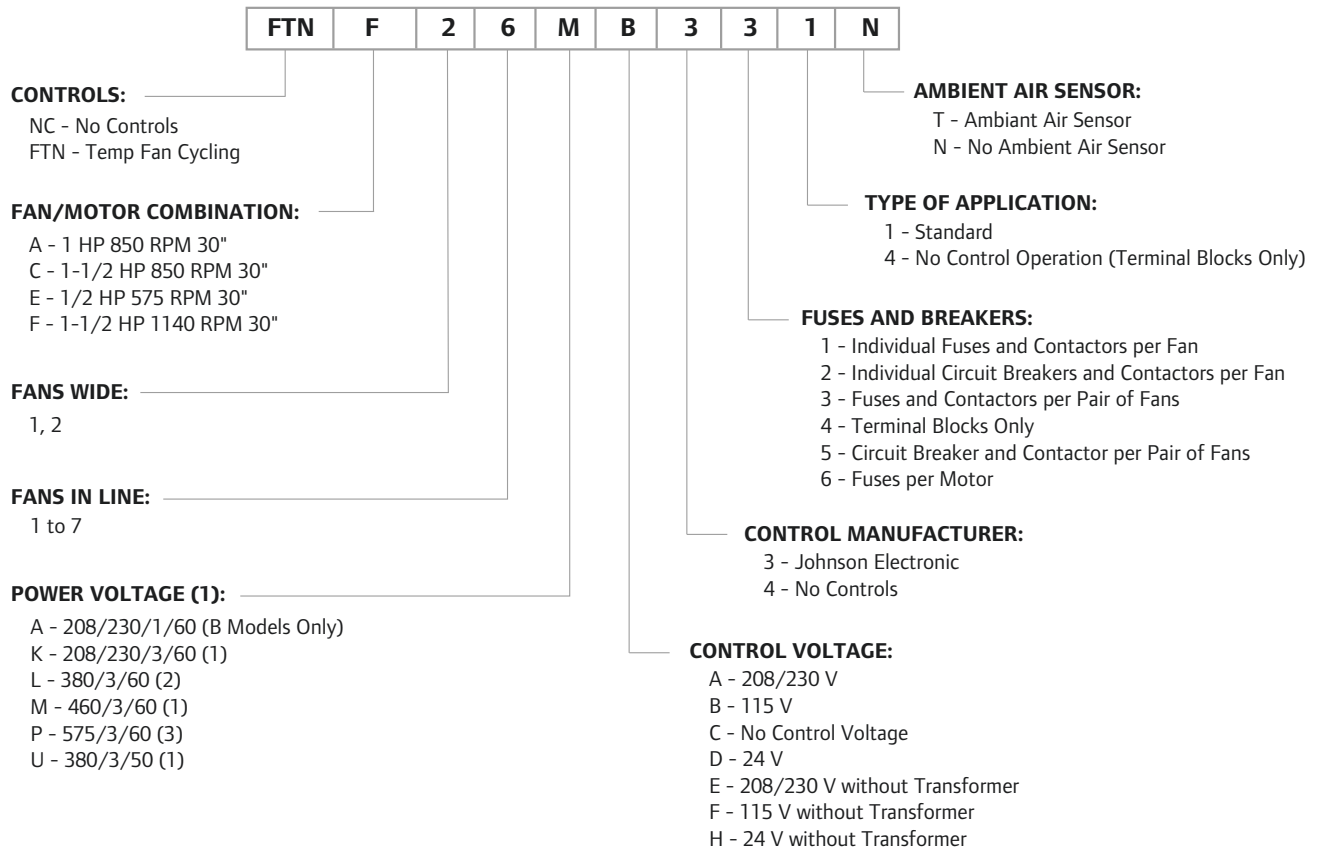

- (1) Invertor suitable motor.
- (2) Contact application engineering for quoting.
- (3) Invertor suitable motor on F and A models.



FLUID COOLER PRODUCT DESCRIPTION

Version: **July 2020**

FLUID COOLER CONTROL PANELS and ELECTRICAL INFORMATION

FAN CONFIGURATION	FTN 311	FTN 331	NC 411	NC 431	NC 461
1 x 1	\$1,240	-	\$950	-	\$630
1 x 2	\$1,770	-	\$1,200	-	\$830
1 x 3	\$2,270	-	\$1,270	-	\$840
1 x 4	\$2,790	-	\$1,640	-	\$1,150
1 x 5	\$3,280	-	\$1,870	-	\$1,310
1 x 6	\$3,750	-	\$2,070	-	\$1,460
1 x 7	\$4,240	-	\$2,270	-	\$1,590
2 x 2	\$2,680	\$1,900	\$2,130	\$1,330	\$1,630
2 x 3	\$3,580	\$2,410	\$2,740	\$1,570	\$2,120
2 x 4	\$4,450	\$2,900	\$3,340	\$1,800	\$2,590
2 x 5	\$5,310	\$3,410	\$3,890	\$2,020	\$3,020
2 x 6	\$6,150	\$3,890	\$4,470	\$2,200	\$3,470
2 x 7	\$7,000	\$4,360	\$5,030	\$2,410	\$3,920

FTN above 130°F requires High Temperature Control adder.

OPTIONS

	Add \$
50/50 Split (2x Only) for Independent Slab Operation	Two 1 x Panels
Phase Loss Monitor	\$1,050
Circuit Breakers: Per Breaker	\$430
NEMA Contactor: Per Contactor	\$370
Mounted Non-Fused Disconnect	\$1,770
Mounted Fused Disconnect (60 amp or less. Fuses not included)	\$1,970
VFD Power Distribution Block	\$620
115 Volt GFI Outlet (not wired)	\$1,020
Control Circuit 10 Amp Disconnect	\$320
HIGH TEMPERATURE Fan Cycle control (above 130* F)	\$540
NEMA 4 Enclosure with Fan Cycling:	\$1,970
NEMA 4 Enclosure with Terminal Blocks:	\$750
NEMA 4X Enclosure 24" Fan Units:	\$1,240
NEMA 4X Enclosure 30" Fan Units:	\$3,290
VENT & DRAIN VALVE EACH (Requires 2 for Double Wide Unit)	\$530
LIQUID TIGHT (Price / Fan)	\$1,080
TEAO, ATO MOTORS (Includes Liquid Tight):	
Std. 2HP 30" Fan Units 208-230/460 V E205860 (Price / Fan)	\$2,380
RELAY BOARDS	
CPC 8RO RELAY BOARD	\$2,590
CPC MULTIFLEX 88 BOARD	\$3,090
AKC - DANFOSS 88 BOARD AND COMM - AK-SC355/255	\$2,590
AKS - DANFOSS 88 BOARD AND COMM - AKS-SM800	\$2,590
MTH - MICROTHERMO MT508	\$2,590
NOVAR #7330130	\$2,590
Ambient Air Sensor - CPC , DANFOSS, NOVAR	\$330
Danfoss BP5 Ambient Temp Sensor with Enclosure	\$610

CONTROL DESCRIPTION

Model 311

Individual Fuses and Contactors,
Plus Fan Cycling Control

Model 331

Fuses and Contactors per Pair of Fans,
Plus Fan Cycle Controls

Model 411

No Fan Cycle Controls,
Individual Fuses and Contactors

Model 431

No Fan Cycle Controls,
Fuses and Contactors per Pair of Fans

Model 461

No Fan Cycle Controls,
Individual Fuses

NOTE: The heading of each column is the last 3 numbers in the Control Panel Nomenclature.

Prices, product availability, and specifications are subject to change without notice.



FLUID COOLER PRODUCT DESCRIPTION

Version: July 2020

FLUID COOLER OPTIONS

Leg Options (30" Fan Units)

FAN CONFIGURATION	DEDUCT FOR NO LEGS REQUIRED	15" LEGS	22" LEGS	30" LEGS	36" LEGS	42" LEGS
1 x 1	(\$80)	N/C	STD	\$190	\$190	\$190
1 x 2	(\$120)	N/C	STD	\$190	\$190	\$190
1 x 3	(\$120)	N/C	STD	\$280	\$280	\$280
1 x 4	(\$120)	N/C	STD	\$280	\$280	\$280
1 x 5	(\$180)	N/C	STD	\$360	\$360	\$360
1 x 6	(\$180)	N/C	STD	\$360	\$360	\$360
1 x 7	(\$220)	N/C	STD	\$460	\$460	\$460
2 x 2	(\$80)	N/C	STD	\$190	\$190	\$190
2 x 3	(\$170)	N/C	STD	\$360	\$360	\$360
2 x 4	(\$120)	N/C	STD	\$280	\$280	\$280
2 x 5	(\$170)	N/C	STD	\$360	\$360	\$360
2 x 6	(\$180)	N/C	STD	\$360	\$360	\$360
2 x 7	(\$220)	N/C	STD	\$460	\$460	\$460

FAN CONFIGURATION	HINGED FAN PANEL	GRAVITY DAMPERS	PAINTED HOUSING
1 x 1	\$370	\$720	\$940
1 x 2	\$740	\$1,440	\$1,880
1 x 3	\$1,110	\$2,160	\$2,820
1 x 4	\$1,480	\$2,880	\$3,760
1 x 5	\$1,850	\$3,600	\$4,700
1 x 6	\$2,220	\$4,320	\$5,640
1 x 7	\$2,590	\$5,040	\$7,520
2 x 2	\$1,480	\$2,860	\$3,740
2 x 3	\$2,220	\$4,290	\$5,610
2 x 4	\$2,960	\$5,720	\$7,480
2 x 5	\$3,700	\$7,150	\$9,350
2 x 6	\$4,440	\$8,580	\$11,220
2 x 7	\$5,180	\$10,010	\$13,090

150# Flanged Connections

	LIST PRICE
In Line Up to 2.5"	\$610
In Line 3"	\$680
In Line 4"	\$740
Double-Wide Up to 2.5"	\$1,230
Double-Wide 3"	\$1,350
Double-Wide 4"	\$1,490

Double-Wide Unit Manifold Kits

	LIST PRICE
Flow Rates 80 to 200 GPM 3.125 ODS or 3 MPT	\$3,090
Flow Rates 201 to 320 GPM 4.125 ODS or 4 MPT	\$4,770

Prices, product availability, and specifications are subject to change without notice.



EC LEVITOR II MODEL KEY

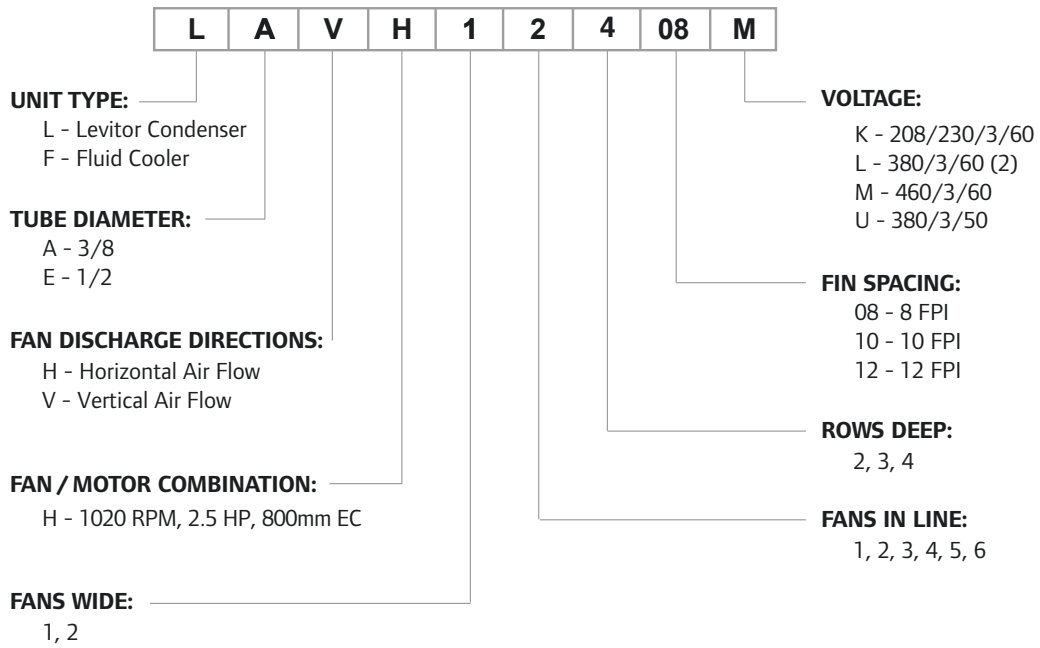

EC MICROCHANNEL MODEL KEY

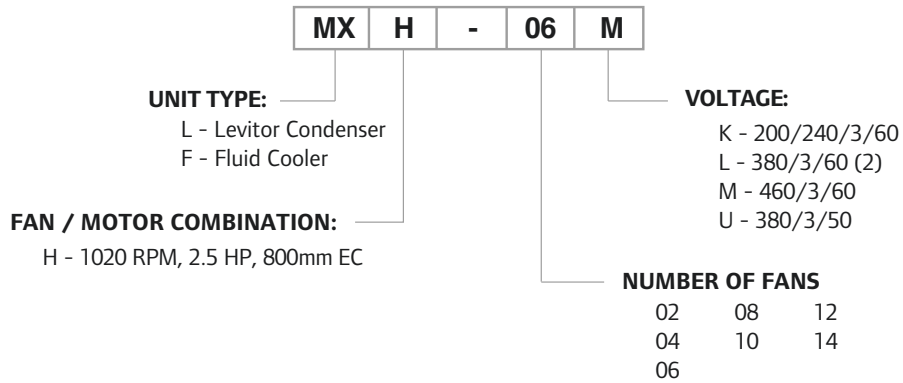

Prices, product availability, and specifications are subject to change without notice.



EC LEVITOR II CONDENSERS

SINGLE FAN WIDE MODELS	List Price	DIMENSIONS (IN)			SHIP WGT (LBS)	TWO FAN WIDE MODELS	List Price	DIMENSIONS (IN)			SHIP WGT (LBS)
		L	W	H				L	W	H	
LAVH 11208	\$11,140	58.00	45.25	65.00	494	-	-	-	-	-	-
LAVH 11210	\$11,200	58.00	45.25	65.00	496	-	-	-	-	-	-
LAVH 11212	\$11,290	58.00	45.25	65.00	501	-	-	-	-	-	-
LAVH 11308	\$11,670	58.00	45.25	65.00	523	-	-	-	-	-	-
LAVH 11310	\$11,750	58.00	45.25	65.00	526	-	-	-	-	-	-
LAVH 11312	\$11,820	58.00	45.25	65.00	535	-	-	-	-	-	-
LAVH 11408	\$11,920	58.00	45.25	65.00	552	-	-	-	-	-	-
LAVH 11410	\$11,990	58.00	45.25	65.00	556	-	-	-	-	-	-
LAVH 11412	\$12,070	58.00	45.25	65.00	565	-	-	-	-	-	-
LAVH 12208	\$18,540	112.00	45.25	65.00	832	LAVH 22208	\$36,970	112.00	90.50	65.00	1,539
LAVH 12210	\$18,710	112.00	45.25	65.00	835	LAVH 22210	\$37,290	112.00	90.50	65.00	1,548
LAVH 12212	\$18,870	112.00	45.25	65.00	843	LAVH 22212	\$37,620	112.00	90.50	65.00	1,564
LAVH 12308	\$19,190	112.00	45.25	65.00	887	LAVH 22308	\$38,250	112.00	90.50	65.00	1,665
LAVH 12310	\$19,400	112.00	45.25	65.00	893	LAVH 22310	\$38,670	112.00	90.50	65.00	1,653
LAVH 12312	\$19,790	112.00	45.25	65.00	906	LAVH 22312	\$39,460	112.00	90.50	65.00	1,690
LAVH 12408	\$21,630	112.00	45.25	65.00	944	LAVH 22408	\$43,120	112.00	90.50	65.00	1,767
LAVH 12410	\$22,150	112.00	45.25	65.00	952	LAVH 22410	\$44,160	112.00	90.50	65.00	1,783
LAVH 12412	\$22,660	112.00	45.25	65.00	969	LAVH 22412	\$45,160	112.00	90.50	65.00	1,816
LAVH 13210	\$28,040	166.00	45.25	65.00	1,212	LAVH 23210	\$55,930	166.00	90.50	65.00	2,217
LAVH 13212	\$28,360	166.00	45.25	65.00	1,231	LAVH 23212	\$56,580	166.00	90.50	65.00	2,254
LAVH 13308	\$28,680	166.00	45.25	65.00	1,297	LAVH 23308	\$57,210	166.00	90.50	65.00	2,386
LAVH 13310	\$29,000	166.00	45.25	65.00	1,306	LAVH 23310	\$57,820	166.00	90.50	65.00	2,405
LAVH 13312	\$29,520	166.00	45.25	65.00	1,324	LAVH 23312	\$58,870	166.00	90.50	65.00	2,442
LAVH 13408	\$31,480	166.00	45.25	65.00	1,381	LAVH 23408	\$63,270	166.00	90.50	65.00	2,556
LAVH 13410	\$32,190	166.00	45.25	65.00	1,394	LAVH 23410	\$64,190	166.00	90.50	65.00	2,580
LAVH 13412	\$32,920	166.00	45.25	65.00	1,418	LAVH 23412	\$65,620	166.00	90.50	65.00	2,629
LAVH 14308	\$38,360	220.00	45.25	65.00	1,665	LAVH 24308	\$76,490	220.00	90.50	65.00	2,982
LAVH 14310	\$38,520	220.00	45.25	65.00	1,677	LAVH 24310	\$76,850	220.00	90.50	65.00	3,107
LAVH 14312	\$39,320	220.00	45.25	65.00	1,702	LAVH 24312	\$78,380	220.00	90.50	65.00	3,156
LAVH 14408	\$41,980	220.00	45.25	65.00	1,778	LAVH 24408	\$83,700	220.00	90.50	65.00	3,307
LAVH 14410	\$42,570	220.00	45.25	65.00	1,794	LAVH 24410	\$84,860	220.00	90.50	65.00	3,340
LAVH 14412	\$43,840	220.00	45.25	65.00	1,827	LAVH 24412	\$87,380	220.00	90.50	65.00	3,406
LAVH 15308	\$51,290	274.00	45.25	69.50	2,305	LAVH 25308	\$102,280	274.00	90.50	69.50	4,295
LAVH 15310	\$51,700	274.00	45.25	69.50	2,320	LAVH 25310	\$103,100	274.00	90.50	69.50	4,325
LAVH 15312	\$52,090	274.00	45.25	69.50	2,351	LAVH 25312	\$103,900	274.00	90.50	69.50	4,387
LAVH 15408	\$52,490	274.00	45.25	69.50	2,445	LAVH 25408	\$104,670	274.00	90.50	69.50	4,575
LAVH 15410	\$53,720	274.00	45.25	69.50	2,466	LAVH 25410	\$107,090	274.00	90.50	69.50	4,616
LAVH 15412	\$54,940	274.00	45.25	69.50	2,507	LAVH 25412	\$109,540	274.00	90.50	69.50	4,699
LEVH 16308	\$60,800	328.00	45.25	69.50	2,896	LEVH 26308	\$121,250	328.00	90.50	69.50	5,443
LEVH 16310	\$61,280	328.00	45.25	69.50	2,915	LEVH 26310	\$122,200	328.00	90.50	69.50	5,480
LEVH 16312	\$61,770	328.00	45.25	69.50	2,952	LEVH 26312	\$123,180	328.00	90.50	69.50	5,554
LEVH 16408	\$62,240	328.00	45.25	69.50	3,126	LEVH 26408	\$124,140	328.00	90.50	69.50	5,902
LEVH 16410	\$62,740	328.00	45.25	69.50	3,150	LEVH 26410	\$125,100	328.00	90.50	69.50	5,952
LEVH 16412	\$63,220	328.00	45.25	69.50	3,200	LEVH 26412	\$126,060	328.00	90.50	69.50	6,050

* See Levitor options for fin coating, legs, hinged fan panel, gravity damper and painted housing pricing.

Prices, product availability, and specifications are subject to change without notice.



EC MICROCHANNEL AIR-COOLED CONDENSER

TWO FAN WIDE MODELS	List Price	THR in MBH (000) @ 10° F TD R-404A	THR in MBH (000) @ 10° F TD R-407A	AIR FLOW (CFM)	DIMENSIONS (IN)			SHIP WGT. (LBS)	REFRIGERANT CHARGE	
					L	W	H*		SUMMER R-404A (LBS)	WINTER R-404A (LBS) -20 F*
MXH-02	\$24,240	171.1	167.0	27,100	44.00	90.25	54.00	674	4	12
MXH-04	\$45,830	342.2	334.0	54,200	88.00	90.25	54.00	1,398	15	26
MXH-06	\$69,830	513.3	501.0	81,300	132.00	90.25	54.00	2,047	23	40
MXH-08	\$90,970	684.4	668.0	108,400	176.00	90.25	54.00	2,736	40	55
MXH-10	\$115,030	855.5	835.0	135,500	220.00	90.25	54.00	3,420	52	77
MXH-12	\$141,910	1,026.6	1,002.0	162,600	264.00	90.25	54.00	4,069	80	88

- Add 22" to height when ship loose legs are required. Add 42" to height when extended legs are specified.
- Add 18" to height for mounted receivers.

Prices, product availability, and specifications are subject to change without notice.



FEVH - FLUID COOLERS

FEVH ONE FAN WIDE MODELS	List Price	Internal Volume (Gal)	DIMENSIONS (IN)			SHIP WGT (LBS)	ElectroFin Coating	Polyester Coating	FEVH TWO FAN WIDE MODELS	List Price	Internal Volume (Gal)	DIMENSIONS (IN)			SHIP WGT (LBS)	ElectroFin Coating	Polyester Coating
			L	W	H							L	W	H			
11208	\$11,260	3.5	58.00	45.25	65.00	504	\$1,190	\$980	-	-	-	-	-	-	-	-	
11210	\$11,340	3.6	58.00	45.25	65.00	506	\$1,190	\$990	-	-	-	-	-	-	-	-	
11212	\$11,420	3.7	58.00	45.25	65.00	511	\$1,190	\$1,000	-	-	-	-	-	-	-	-	
11308	\$11,800	5.0	58.00	45.25	65.00	538	\$1,300	\$1,060	-	-	-	-	-	-	-	-	
11310	\$11,880	5.2	58.00	45.25	65.00	541	\$1,300	\$1,080	-	-	-	-	-	-	-	-	
11312	\$11,970	5.3	58.00	45.25	65.00	550	\$1,300	\$1,100	-	-	-	-	-	-	-	-	
11408	\$12,040	6.5	58.00	45.25	65.00	572	\$1,350	\$1,110	-	-	-	-	-	-	-	-	
11410	\$12,120	6.5	58.00	45.25	65.00	572	\$1,350	\$1,120	-	-	-	-	-	-	-	-	
11412	\$12,220	6.9	58.00	45.25	65.00	585	\$1,350	\$1,130	-	-	-	-	-	-	-	-	
12208	\$18,720	6.4	112.00	45.25	65.00	852	\$1,700	\$1,390	22208	\$37,300	12.4	112.00	90.50	65.00	1,579	\$3,370	\$2,770
12210	\$18,880	6.5	112.00	45.25	65.00	855	\$1,700	\$1,410	22210	\$37,630	12.6	112.00	90.50	65.00	1,588	\$3,370	\$2,810
12212	\$19,040	6.6	112.00	45.25	65.00	863	\$1,700	\$1,440	22212	\$37,960	12.8	112.00	90.50	65.00	1,604	\$3,370	\$2,840
12308	\$19,360	9.5	112.00	45.25	65.00	917	\$1,820	\$1,500	22308	\$38,620	18.7	112.00	90.50	65.00	1,725	\$3,620	\$2,950
12310	\$19,580	9.6	112.00	45.25	65.00	923	\$1,820	\$1,520	22310	\$39,040	18.9	112.00	90.50	65.00	1,713	\$3,620	\$3,020
12312	\$19,980	9.7	112.00	45.25	65.00	936	\$1,820	\$1,570	22312	\$39,830	19.1	112.00	90.50	65.00	1,750	\$3,620	\$3,140
12408	\$21,870	16.4	112.00	45.25	65.00	984	\$2,320	\$1,840	22408	\$43,590	24.8	112.00	90.50	65.00	1,847	\$4,590	\$3,680
12410	\$22,390	16.5	112.00	45.25	65.00	992	\$2,320	\$1,930	22410	\$44,620	25.0	112.00	90.50	65.00	1,863	\$4,590	\$3,830
12412	\$22,900	16.6	112.00	45.25	65.00	1,009	\$2,320	\$2,020	22412	\$45,640	25.3	112.00	90.50	65.00	1,896	\$4,590	\$3,980
13210	\$28,300	9.5	166.00	45.25	65.00	1,242	\$2,550	\$2,120	23210	\$56,450	18.5	166.00	90.50	65.00	2,277	\$5,040	\$4,200
13212	\$28,620	9.6	166.00	45.25	65.00	1,261	\$2,550	\$2,160	23212	\$57,110	18.7	166.00	90.50	65.00	2,314	\$5,040	\$4,300
13308	\$28,950	13.7	166.00	45.25	65.00	1,327	\$2,710	\$2,200	23308	\$57,760	27.4	166.00	90.50	65.00	2,476	\$5,380	\$4,390
13310	\$29,280	13.9	166.00	45.25	65.00	1,351	\$2,710	\$2,260	23310	\$58,390	27.7	166.00	90.50	65.00	2,495	\$5,380	\$4,480
13312	\$29,820	14.1	166.00	45.25	65.00	1,369	\$2,710	\$2,340	23312	\$59,450	27.9	166.00	90.50	65.00	2,532	\$5,380	\$4,640
13408	\$31,790	18.3	166.00	45.25	65.00	1,426	\$3,280	\$2,640	23408	\$63,920	36.7	166.00	90.50	65.00	2,673	\$6,540	\$5,290
13410	\$32,530	18.5	166.00	45.25	65.00	1,454	\$3,280	\$2,740	23410	\$64,840	36.9	166.00	90.50	65.00	2,697	\$6,540	\$5,450
13412	\$33,260	18.7	166.00	45.25	65.00	1,478	\$3,280	\$2,840	23412	\$66,330	37.1	166.00	90.50	65.00	2,746	\$6,540	\$5,650
14308	\$38,720	18.2	220.00	45.25	65.00	1,725	\$3,580	\$2,960	24308	\$77,210	36.3	220.00	90.50	65.00	3,097	\$7,110	\$5,890
14310	\$38,900	18.4	220.00	45.25	65.00	1,737	\$3,580	\$2,980	24310	\$77,570	36.5	220.00	90.50	65.00	3,222	\$7,110	\$5,930
14312	\$39,690	18.6	220.00	45.25	65.00	1,762	\$3,580	\$3,100	24312	\$79,140	36.7	220.00	90.50	65.00	3,271	\$7,110	\$6,170
14408	\$42,410	24.0	220.00	45.25	65.00	1,838	\$4,320	\$3,490	24408	\$84,560	48.4	220.00	90.50	65.00	3,460	\$8,570	\$6,960
14410	\$43,000	24.3	220.00	45.25	65.00	1,871	\$4,320	\$3,600	24410	\$85,750	48.6	220.00	90.50	65.00	3,493	\$8,570	\$7,140
14412	\$44,300	24.6	220.00	45.25	65.00	1,904	\$4,320	\$3,790	24412	\$88,320	48.8	220.00	90.50	65.00	3,559	\$8,570	\$7,520
15308	\$51,810	22.5	274.00	45.25	69.50	2,382	\$5,120	\$4,210	25308	\$103,310	45.2	274.00	90.50	69.50	4,438	\$10,170	\$8,350
15310	\$52,230	22.7	274.00	45.25	69.50	2,391	\$5,120	\$4,260	25310	\$104,150	45.4	274.00	90.50	69.50	4,468	\$10,170	\$8,480
15312	\$52,630	22.9	274.00	45.25	69.50	2,422	\$5,120	\$4,330	25312	\$104,950	45.6	274.00	90.50	69.50	4,530	\$10,170	\$8,590
15408	\$53,010	30.2	274.00	45.25	69.50	2,516	\$5,480	\$4,380	25408	\$105,750	60.3	274.00	90.50	69.50	4,765	\$10,900	\$8,700
15410	\$54,260	30.3	274.00	45.25	69.50	2,561	\$5,480	\$4,570	25410	\$108,220	60.5	274.00	90.50	69.50	4,806	\$10,900	\$9,080
15412	\$55,530	30.5	274.00	45.25	69.50	2,602	\$5,480	\$4,740	25412	\$110,720	60.7	274.00	90.50	69.50	4,889	\$10,900	\$9,440
16308	\$60,800	27.0	328.00	45.25	69.50	2,991	\$6,000	\$4,930	26308	\$121,250	54.2	328.00	90.50	69.50	5,443	\$11,920	\$9,810
16310	\$61,280	27.2	328.00	45.25	69.50	2,915	\$6,000	\$5,000	26310	\$122,200	54.4	328.00	90.50	69.50	5,480	\$11,920	\$9,930
16312	\$61,770	27.4	328.00	45.25	69.50	2,952	\$6,000	\$5,090	26312	\$123,180	54.6	328.00	90.50	69.50	5,554	\$11,920	\$10,090
16408	\$62,240	35.7	328.00	45.25	69.50	3,126	\$6,280	\$5,150	26408	\$124,140	72.1	328.00	90.50	69.50	5,902	\$12,440	\$10,230
16410	\$62,740	36.0	328.00	45.25	69.50	3,150	\$6,280	\$5,230	26410	\$125,100	72.3	328.00	90.50	69.50	5,952	\$12,440	\$10,370
16412	\$63,220	36.4	328.00	45.25	69.50	3,200	\$6,280	\$5,280	26412	\$126,060	72.5	328.00	90.50	69.50	6,050	\$12,440	\$10,510

* See Levitor options for legs, hinged fan panel, gravity damper and painted housing pricing.

Prices, product availability, and specifications are subject to change without notice.



EC LEVITOR II CONTROL PANEL NOMENCLATURE

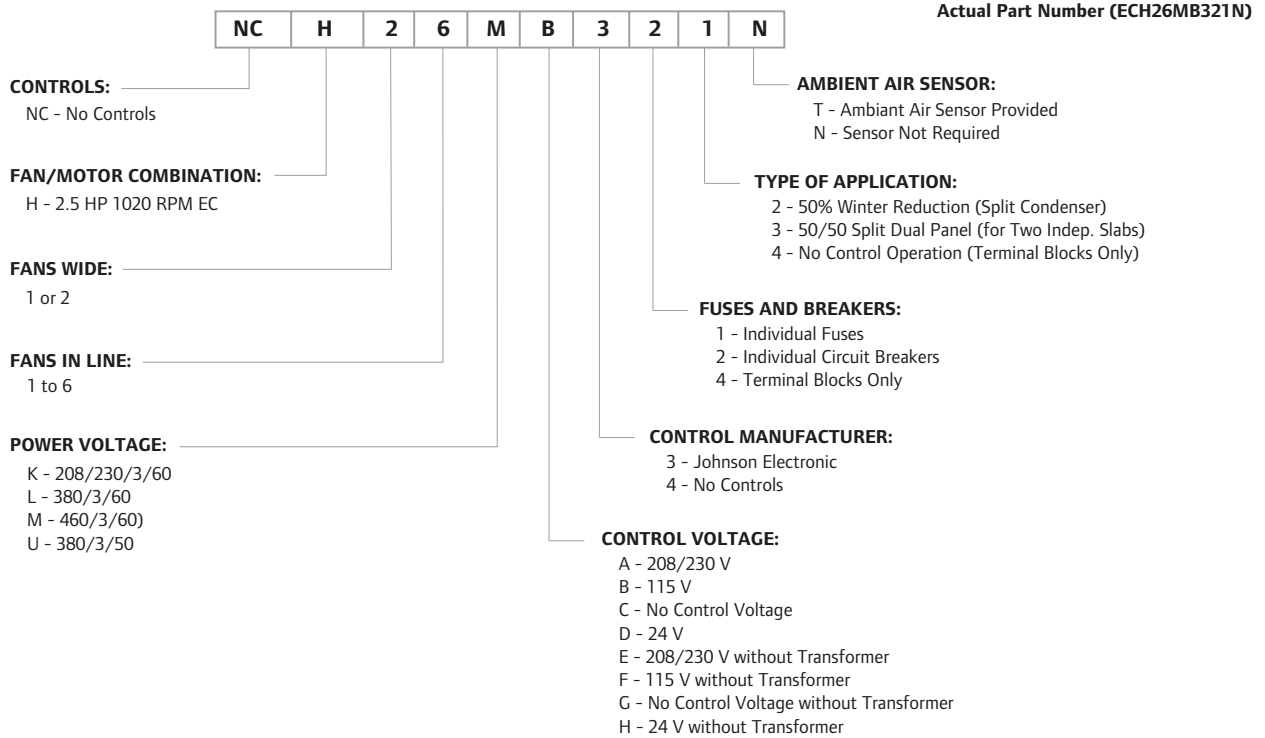

EC MICROCHANNEL CONTROL PANEL NOMENCLATURE

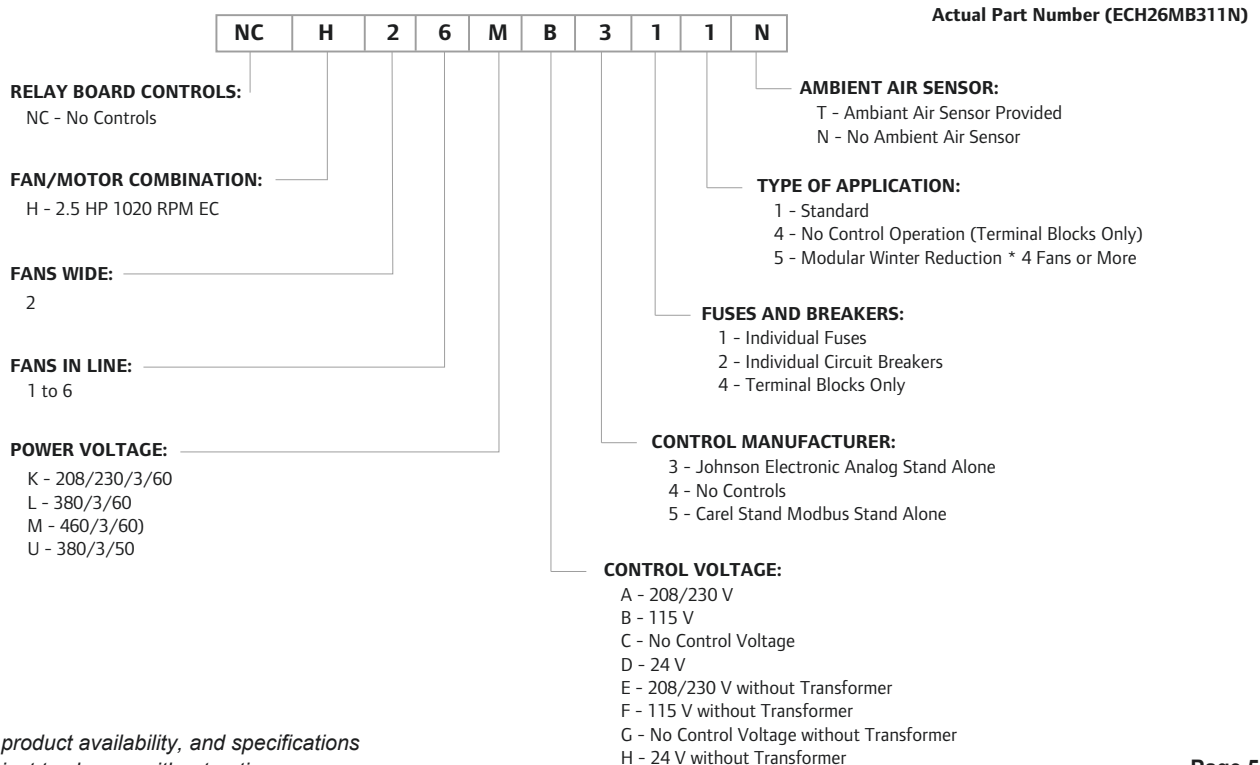

Prices, product availability, and specifications are subject to change without notice.



EC LEVITOR II CONTROL PANELS

FAN CONFIGURATION	411
1 x 1	\$630
1 x 2	\$830
1 x 3	\$840
1 x 4	\$1,150
1 x 5	\$1,310
1 x 6	\$1,460
2 x 2	\$1,630
2 x 3	\$2,120
2 x 4	\$2,590
2 x 5	\$3,020
2 x 6	\$3,470

Note: The heading of each column is the last 3 numbers in the Control Panel Nomenclature.

CONTROL DESCRIPTION

Model 411

No Fan Speed Controls, Individual Fuses

Options	Add \$
50% Reduction Relay (2x Only)	\$280
50/50 Split (2x Only)	Two 1 x Panel
Phase Loss Monitor	\$1,050
Circuit Breakers: Per Breaker	\$430
Mounted Non-Fused Disconnect	\$1,770
Mounted Fused Disconnect (Less Fuses)	\$1,970
Control Circuit Cutoff Switch (115 V)	\$310
(230 V)	\$610
Drop Leg Transducer Tap with Transducer	\$1,530
Drop Leg Pressure Transducer Tap	\$310
Danfoss BP5 Ambient Temp Sensor with Enclosure	\$610
Rochester Liquid Level Guage with Alarm Circuit	\$2,800
Hot Gas Header	\$1,600
Rupture Disc Assembly	\$4,190
Relay Boards	
Ambient Air Sensor - CPC , DANFOSS, NOVAR	\$330
CPC-4AO ANALOG BOARD	\$2,590
DANFOSS 4 R/O BOARD	\$2,590
DANFOSS ANALOG BOARD AK2	\$2,590
CPC MULTIFLEX 88 BOARD	\$3,090

NOTE: For panels without fuses, consult factory.

Contact factory for pricing of Electronic Controllers and Relay Boards.

Prices, product availability, and specifications are subject to change without notice.



EC MICROCHANNEL CONTROL PANELS

FAN CONFIGURATION	411
02	\$820
04	\$1,630
06	\$2,110
08	\$2,590
10	\$3,020
12	\$3,470

Note: The heading of each column is the last 3 numbers in the Control Panel Nomenclature.

CONTROL DESCRIPTION

Model 411

No Fan Speed Controls, Individual Fuses

Options	
Option Particular	Add
Phase Loss Monitor	\$1,050
Circuit Breakers: Per Breaker	\$430
Mounted Non-Fused Disconnect	\$1,770
Relay Boards	
Ambient Air Sensor - CPC , DANFOSS, NOVAR	\$330
CPC-4AO ANALOG BOARD	\$2,590
DANFOSS 4 R/O BOARD	\$2,590
DANFOSS ANALOG BOARD AK2	\$2,590
CPC MULTIFLEX 88 BOARD	\$3,090

NOTE: For panels without fuses, consult factory.

Contact factory for pricing of Electronic Controllers and Relay Boards.

Prices, product availability, and specifications are subject to change without notice.



EC FLUID COOLER CONTROL PANELS and ELECTRICAL INFORMATION

FAN CONFIGURATION	411
1 x 1	\$630
1 x 2	\$820
1 x 3	\$840
1 x 4	\$1,150
1 x 5	\$1,310
1 x 6	\$1,450
2 x 2	\$1,630
2 x 3	\$2,110
2 x 4	\$2,590
2 x 5	\$3,020
2 x 6	\$3,470

Note: The heading of each column is the last 3 numbers in the Control Panel Nomenclature.

CONTROL DESCRIPTION

Model 411

No Fan Speed Controls, Individual Fuses

Options

Option Particular	
Circuit Breakers: Per Breaker	\$430
Phase Loss Monitor	\$1,050

NEMA 4 Enclosure with Terminal Blocks:	\$670
NEMA 4X Enclosure 30" Fan Units:	\$3,290
Mounted Non-Fused Disconnect:	\$1,770

Prices, product availability, and specifications are subject to change without notice.



H-SERIES LEGACY MODEL KEY

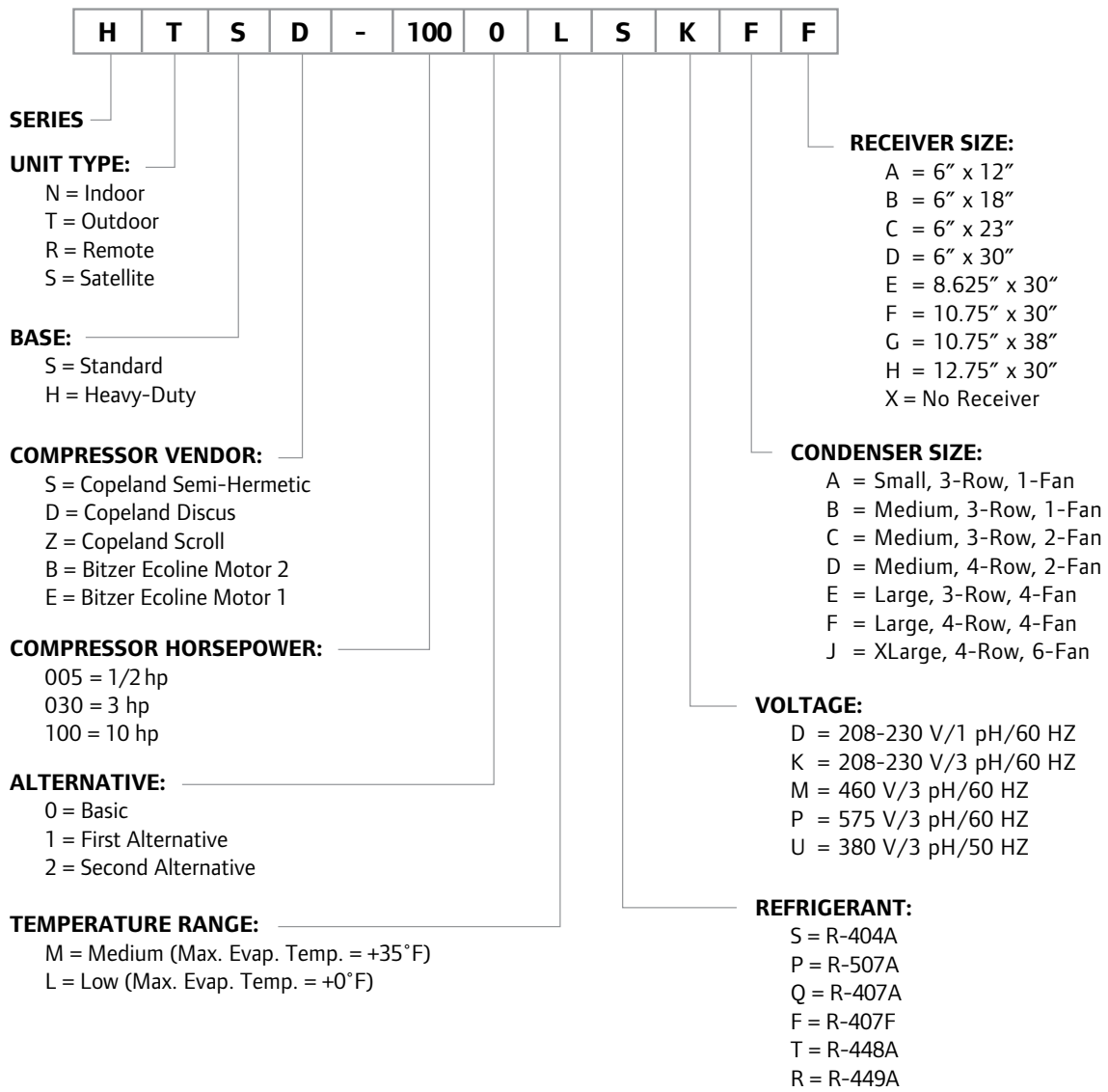

This product line does not have AWEF numbers and may only be applied with refrigeration loads that are not regulated by the DOE/NRCan.



HTSS - H-SERIES LEGACY COPELAND SEMI-HERMETIC CONDENSING UNITS

UNIT MODEL	COMPRESSOR MODEL	LIST PRICE			4 Year Extended Compressor	CAPACITY (MBH) @ 95° F Ambient		TECHNICAL SPECIFICATION					SHIP WGT (LBS)
		208/1/60 D	208/3/60 K	460/3/60 M		R-404A	R-448A	Cabinet Size	Cond Size	Rcvr Size	Connections		
Semi-Hermetic - Low Temperature - R-404A / R-448A (not available R-407A)						-20° F Evap					Liquid	Suction	
HTSS-0050LS	KAN# - 00#E	\$5,830	\$5,830	-	\$1,010	2.00	1.50	SMALL	A	B	1/2	7/8	400
HTSS-0070LS	KAM# - 007E	\$6,070	\$6,070	-	\$1,010	3.38	2.50	SMALL	A	B	1/2	7/8	400
HTSS-0100LS	KAJ# - 011E	-	\$6,080	\$6,540	\$1,010	4.56	3.32	SMALL	A	B	1/2	7/8	400
HTSS-0150LS	KAL# - 015E	\$6,910	\$6,910	\$7,360	\$1,130	6.65	4.72	SMALL	A	B	1/2	7/8	400
HTSS-0200LS	EAV# - 021E	\$7,750	\$7,750	\$8,180	\$1,050	8.21	8.62	SMALL	A	B	1/2	7/8	400
HTSS-0250LS	LAH# - 032E	\$9,730	\$9,730	\$10,180	\$1,500	14.28	13.20	MEDIUM	B	C	1/2	1-1/8	550
Semi-Hermetic - Med Temperature - R-404A / R-448A (not available R-407A)						+25° F Evap	+20° F Evap						
HTSS-0072MS	KAN# - 007E	\$6,060	\$6,060	-	\$1,010	6.92	6.11	SMALL	A	B	1/2	7/8	400
HTSS-0100MS	KAR# - 010E	\$6,180	\$6,180	\$6,640	\$1,010	9.80	8.77	SMALL	A	B	1/2	7/8	400
HTSS-0200MS	KAK# - 020E	\$6,550	\$6,550	-	\$1,230	15.10	13.60	SMALL	A	B	1/2	7/8	400
HTSS-0201MS	ERC# - 021E	-	\$6,840	\$7,290	\$1,390	20.70	17.70	SMALL	A	B	1/2	7/8	400
HTSS-0300MS	ERF# - 031E	\$8,690	\$8,690	\$9,140	\$1,450	29.49	25.50	MEDIUM	B	C	1/2	1-1/8	550

* H-SERIES OPTIONS PAGE HAS STANDARD FEATURES AND BASIC OPTIONS LIST. USE H SERIES SOFTWARE FOR ADDITIONAL CUSTOMIZATION.

** ORDERS FOR CONDENSING UNITS MUST INCLUDE THE FULL MODEL NUMBER INCLUDING CONDENSER AND RECEIVER "HTSS-0200MSAB"

CABINET SIZE	L	W	H
Small	41.8	32.3	24.5
Medium	48.0	34.1	41.9
Large	84.0	35.1	41.9
X-Large	99.0	35.0	54.4

Standard Options on HTSS units include sealed liquid drier, pumpdown switch, time clock, solid mounted compressor and crating.

RECEIVER SIZE	CAPACITY (LBS @ 90%)				LIST PRICE TO UPGRADE TO RECEIVER SINE	MINIMUM CABINET SINE
	R-22	R-404A/507	R-407A	R-448A		
A 6 X 12	12.8	11.1	12.2	11.6	-	SMALL
B 6 X 18	19.2	16.7	18.3	17.4	\$210	SMALL
C 6 X 23	24.6	21.4	23.4	22.3	\$50	MEDIUM
D 6 X 30	32.0	27.9	30.4	29.0	\$40	MEDIUM
E 8-5/8 X 30	62.0	53.9	59.0	56.2	\$440	MEDIUM
F 10-3/4 X 30	94.6	82.3	90.0	85.8	\$250	LARGE
H 12-3/4 X 30	115.0	100.1	109.4	104.3	\$720	LARGE

* CALCULATE COST FOR LARGER RECEIVER - ADD COST FOR EACH SIZE CHANGE (EXAMPLE - INCREASE SIZE FROM A TO C COST IS \$190 + \$50 = \$240)

This product line does not have AWEF numbers and may only be applied with refrigeration loads that are not regulated by the DOE/NRCAn.

Prices, product availability, and specifications are subject to change without notice.



H-SERIES LEGACY PRODUCT DESCRIPTION

Version: July 2020

HTSD - H-SERIES LEGACY COPELAND DISCUS CONDENSING UNITS

UNIT MODEL	COMPRESSOR MODEL	LIST PRICE			4 Year Extended Compressor Warranty	CAPACITY (MBH) @ 95° F Ambient		TECHNICAL SPECIFICATION					SHIP WGT (LBS)	
		208/1/60 D	208/3/60 K	460/3/60 M		+25 F Evap	-20 F Evap	Cabinet Size	Cond Size	Rcvr Size	Connections			
													Liquid	Suction
Discus - Medium Temperature - R-404A														
HTSD-0500MS	2DC3R53KE	-	\$12,950	\$13,410	\$1,810	43.00	-	MEDIUM	B	D	5/8	1-3/8	800	
HTSD-0501MS	2DD3R63KE	-	\$13,020	\$13,470	\$1,810	50.00	-	MEDIUM	B	D	5/8	1-3/8	800	
HTSD-0750MS	2DL3R78KE	-	\$15,230	\$15,740	\$2,250	60.50	-	MEDIUM	D	E	5/8	1-3/8	800	
HTSD-0751MS	2DA3R89KE	-	\$18,340	\$18,970	\$2,250	72.50	-	LARGE	E	H	5/8	1-3/8	1,250	
HTSD-0752MS	3DA3R10ME	-	\$18,880	\$19,470	\$2,250	82.50	-	LARGE	E	H	5/8	1-3/8	1,250	
HTSD-1000MS	3DB3R12ME	-	\$20,050	\$20,640	\$2,870	98.00	-	LARGE	F	H	7/8	1-3/8	1,250	
HTSD-1200MS	3DF3R15ME	-	\$23,700	\$24,370	\$3,290	125.70	-	X-LARGE	J	H	7/8	1-3/8	1,575	
HTSD-1500MS	3DS3R17ME	-	\$23,830	\$24,400	\$4,350	136.40	-	X-LARGE	J	H	7/8	1-5/8	1,575	
Discus - Low Temperature - R-404A														
HTSD-0300LS	2DF3F16KE	-	\$12,770	\$13,220	\$2,480	-	20.00	MEDIUM	B	C	5/8	1-3/8	800	
HTSD-0400LS	2DL3F20KE	-	\$13,220	\$13,670	\$2,530	-	22.90	MEDIUM	B	D	5/8	1-3/8	800	
HTSD-0600LS	2DB3F25KE	-	\$13,730	\$14,160	\$2,620	-	27.30	MEDIUM	B	D	5/8	1-3/8	800	
HTSD-0601LS	3DA3F28KE	-	\$14,960	\$15,460	\$3,580	-	30.80	MEDIUM	D	E	5/8	1-3/8	800	
HTSD-0750LS	3DB3F33KE	-	\$18,260	\$18,900	\$3,560	-	37.40	LARGE	E	F	5/8	1-3/8	1,250	
HTSD-0900LS	3DF3F40KE	-	\$19,000	\$19,600	\$3,740	-	44.60	LARGE	E	F	5/8	1-3/8	1,250	
HTSD-1000LS	3DS3F46KE	-	\$21,140	\$21,740	\$4,130	-	51.00	LARGE	F	H	7/8	1-3/8	1,250	
HTSD-1500LS	4DHF63KE	-	\$26,850	\$27,490	\$5,250	-	70.40	X-LARGE	J	H	7/8	1-5/8	1,575	
HTSD-2200LS	4DJNF76KE	-	\$27,220	\$27,640	\$5,250	-	83.64	X-LARGE	J	H	7/8	1-5/8	1,575	

UNIT MODEL	COMPRESSOR MODEL	LIST PRICE			4 Year Extended Compressor Warranty	CAPACITY (MBH) @ 95° F Ambient		TECHNICAL SPECIFICATION					SHIP WGT (LBS)			
		208/1/60 D	208/3/60 K	460/3/60 M		R-448A	R-407A	Cabinet Size	Cond Size	Rcvr Size	Connections					
													Liquid	Suction		
Discus - Medium Temperature - R-448A / R-407A																
													+25 F Evap			
HTSD-0500MQ	2DC3R53KE	-	\$12,950	\$13,410	\$1,810	44.70	43.70	MEDIUM	B	D	5/8	1-3/8	800			
HTSD-0501MQ	2DD3R63KE	-	\$13,020	\$13,470	\$1,810	50.70	49.30	MEDIUM	B	D	5/8	1-3/8	800			
HTSD-0750MQ	2DL3R78KE	-	\$15,230	\$15,740	\$2,250	62.90	61.40	MEDIUM	D	E	5/8	1-3/8	800			
HTSD-0751MQ	2DA3R89KE	-	\$18,340	\$18,970	\$2,250	74.00	72.20	LARGE	E	H	5/8	1-3/8	1,250			
HTSD-0752MQ	3DA3R10ME	-	\$18,880	\$19,470	\$2,250	86.80	85.30	LARGE	E	H	5/8	1-3/8	1,250			
HTSD-1000MQ	3DB3R12ME	-	\$20,050	\$20,640	\$2,870	103.50	101.40	LARGE	F	H	7/8	1-3/8	1,250			
HTSD-1200MQ	3DF3R15ME	-	\$23,700	\$24,370	\$3,290	126.50	122.30	X-LARGE	J	H	7/8	1-3/8	1,575			
HTSD-1500MQ	3DS3R17ME	-	\$23,830	\$24,400	\$4,350	142.90	138.20	X-LARGE	J	H	7/8	1-5/8	1,575			
Discus - Low Temperature - R-448A / R-407A																
													-20° F Evap			
HTSD-0300LQ	2DF3F16KE	-	\$14,290	\$14,740	\$2,480	17.60	16.70	MEDIUM	B	C	5/8	1-3/8	800			
HTSD-0400LQ	2DL3F20KE	-	\$14,740	\$15,180	\$2,530	21.00	19.90	MEDIUM	B	D	5/8	1-3/8	800			
HTSD-0600LQ	2DB3F25KE	-	\$15,700	\$16,140	\$2,620	25.10	24.20	MEDIUM	B	D	5/8	1-3/8	800			
HTSD-0601LQ	3DA3F28KE	-	\$16,470	\$16,980	\$3,580	28.60	27.60	MEDIUM	D	E	5/8	1-3/8	800			
HTSD-0750LQ	3DB3F33KE	-	\$19,780	\$20,430	\$3,560	36.40	34.60	LARGE	E	F	5/8	1-3/8	1,250			
HTSD-0900LQ	3DF3F40KE	-	\$20,500	\$21,090	\$3,740	42.00	40.40	LARGE	E	F	5/8	1-3/8	1,250			
HTSD-1000LQ	3DS3F46KE	-	\$22,660	\$23,250	\$4,130	46.70	45.00	LARGE	F	H	7/8	1-3/8	1,250			
HTSD-1500LQ	4DHF63KE	-	\$28,320	\$28,950	\$5,250	66.80	63.40	X-LARGE	J	H	7/8	1-5/8	1,575			
HTSD-2200LQ	4DJNF76KE	-	\$28,680	\$29,110	\$5,250	83.96	78.90	X-LARGE	J	H	7/8	1-5/8	1,575			

* H-SERIES OPTIONS PAGE HAS STANDARD FEATURES AND BASIC OPTIONS LIST. USE H SERIES SOFTWARE FOR ADDITIONAL CUSTOMIZATION.

** ORDERS FOR CONDENSING UNITS MUST INCLUDE THE FULL MODEL NUMBER INCLUDING CONDENSER AND RECEIVER "HTSD-0500MSBD"

CABINET SIZE	L	W	H
Small	41.8	32.3	24.5
Medium	48.0	34.1	41.9
Large	84.0	35.1	41.9
X-Large	99.0	35.0	54.4

Standard Options on HTSD units include sealed liquid drier, pumpdown switch, time clock, solid mounted compressor and crating.

RECEIVER SIZE	CAPACITY (LBS @ 90%)				LIST PRICE TO UPGRADE TO RECEIVER SIZE	MINIMUM CABINET SIZE
	R-22	R-404A/507	R-407A	R-448A		
A 6 X 12	12.8	11.1	12.2	11.6	-	SMALL
B 6 X 18	19.2	16.7	18.3	17.4	\$210	SMALL
C 6 X 23	24.6	21.4	23.4	22.3	\$50	MEDIUM
D 6 X 30	32.0	27.9	30.4	29.0	\$40	MEDIUM
E 8-5/8 X 30	62.0	53.9	59.0	56.2	\$440	MEDIUM
F 10-3/4 X 30	94.6	82.3	90.0	85.8	\$250	LARGE
H 12-3/4 X 30	115.0	100.1	109.4	104.3	\$720	LARGE

* CALCULATE COST FOR LARGER RECEIVER - ADD COST FOR EACH SIZE CHANGE (EXAMPLE - INCREASE SIZE FROM A TO C COST IS \$190 + \$50 = \$240)

This product line does not have AWEF numbers and may only be applied with refrigeration loads that are not regulated by the DOE/NRCAn.

Prices, product availability, and specifications are subject to change without notice.



HTSZ - H-SERIES LEGACY COPELAND SCROLL CONDENSING UNITS

UNIT MODEL	COMPRESSOR MODEL	LIST PRICE			4 Year Extended Compressor Warranty	CAPACITY (MBH) @ 95° F Ambient		TECHNICAL SPECIFICATION					SHIP WGT (LBS)
		208/1/60 D	208/3/60 K	460/3/60 M		+25 F Evap	-20 F Evap	Cabinet Size	Cond Size	Rcvr Size	Connections		
Scroll - Medium Temperature - R-404A													
HTSZ-0200MS	ZB15KCE	\$6,340	\$6,330	\$6,790	\$1,080	17.30	-	SMALL	A	B	1/2	7/8	400
HTSZ-0250MS	ZB19KCE	\$7,080	\$7,070	\$7,540	\$1,080	23.10	-	MEDIUM	B	D	1/2	7/8	650
HTSZ-0300MS	ZB21KCE	\$7,720	\$7,710	\$8,230	\$1,080	26.70	-	MEDIUM	B	D	1/2	7/8	650
HTSZ-0350MS	ZB26KCE	\$8,030	\$8,020	\$8,480	\$1,080	30.50	-	MEDIUM	B	E	1/2	7/8	650
HTSZ-0400MS	ZB30KCE	\$8,410	\$8,480	\$8,850	\$1,080	34.20	-	MEDIUM	B	E	1/2	7/8	650
HTSZ-0500MS	ZB38KCE	\$8,640	\$8,630	\$9,150	\$1,080	43.90	-	MEDIUM	B	E	5/8	7/8	650
HTSZ-0600MS	ZB48KCE	-	\$9,630	\$10,150	\$1,080	57.50	-	MEDIUM	D	E	5/8	7/8	650
HTSZ-0750MS	ZB58K5E	-	\$15,020	\$15,690	\$2,110	70.00	-	LARGE	E	F	5/8	1-3/8	1,200
HTSZ-1000MS	ZB76K5E	-	\$18,180	\$18,710	\$2,110	90.60	-	LARGE	F	H	5/8	1-3/8	1,200
HTSZ-1300MS	ZB95K5E	-	\$22,550	\$23,180	\$2,110	111.80	-	X-LARGE	J	H	7/8	1-5/8	1,550
HTSZ-1500MS	ZB114K5E	-	\$22,880	\$23,300	\$2,400	138.70	-	X-LARGE	J	H	7/8	1-5/8	1,550
Scroll - Low Temperature - R-404A													
HTSZ-0200LS	ZF06K4E	\$6,750	\$6,750	\$7,210	\$1,440	-	7.40	SMALL	A	B	1/2	7/8	400
HTSZ-0250LS	ZF08K4E	\$6,950	\$6,950	\$7,390	\$1,440	-	9.10	SMALL	A	B	1/2	7/8	400
HTSZ-0300LS	ZF09K4E	\$8,900	\$8,890	\$9,340	\$1,440	-	10.80	MEDIUM	B	C	1/2	7/8	650
HTSZ-0350LS	ZF11K4E	\$8,430	\$8,420	\$8,880	\$1,440	-	13.30	MEDIUM	B	C	1/2	7/8	650
HTSZ-0400LS	ZF13K4E	\$8,740	\$8,730	\$9,180	\$1,440	-	15.10	MEDIUM	B	C	1/2	7/8	650
HTSZ-0500LS	ZF15K4E	\$9,140	\$9,130	\$9,580	\$1,570	-	18.40	MEDIUM	B	C	5/8	7/8	650
HTSZ-0600LS	ZF18K4E	-	\$9,220	\$9,670	\$1,570	-	22.00	MEDIUM	B	C	5/8	7/8	650
HTSZ-0750LS	ZF25K4E	-	\$12,450	\$12,900	\$1,570	-	26.60	MEDIUM	B	C	5/8	1-3/8	650
HTSZ-1000LS	ZF34K5E	-	\$20,790	\$21,380	\$2,120	-	35.90	LARGE	E	F	5/8	1-3/8	1,200

UNIT MODEL	COMPRESSOR MODEL	LIST PRICE			4 Year Extended Compressor	CAPACITY (MBH) @ 95° F Ambient		TECHNICAL SPECIFICATION					SHIP WGT (LBS)
		208/1/60 D	208/3/60 K	460/3/60 M		R-448A	R-407A	Cabinet Size	Cond Size	Rcvr Size	Connections		
Scroll - Medium Temperature - R-448A / R-407A													
+25 F Evap													
HTSZ-0200MQ	ZB15KCE	\$6,340	\$6,330	\$6,790	\$1,080	18.40	18.40	SMALL	A	B	1/2	7/8	400
HTSZ-0250MQ	ZB19KCE	\$7,080	\$7,070	\$7,070	\$1,080	22.50	21.70	MEDIUM	B	D	1/2	7/8	650
HTSZ-0300MQ	ZB21KCE	\$7,720	\$7,710	\$8,230	\$1,080	26.40	26.70	MEDIUM	B	D	1/2	7/8	650
HTSZ-0350MQ	ZB26KCE	\$8,030	\$8,020	\$8,480	\$1,080	31.50	29.70	MEDIUM	B	E	1/2	7/8	650
HTSZ-0400MQ	ZB30KCE	\$8,410	\$8,480	\$8,850	\$1,080	37.00	37.90	MEDIUM	B	E	5/8	7/8	650
HTSZ-0500MQ	ZB38KCE	\$8,640	\$8,630	\$9,150	\$1,080	45.20	46.00	MEDIUM	B	E	5/8	7/8	650
HTSZ-0600MQ	ZB48KCE	-	\$9,630	\$10,150	\$1,080	59.50	58.50	MEDIUM	D	E	5/8	7/8	650
HTSZ-0750MQ	ZB58K5E	-	\$15,690	\$15,690	\$2,110	71.50	68.70	LARGE	E	F	5/8	1-3/8	1,200
HTSZ-1000MQ	ZB76K5E	-	\$19,900	\$19,450	\$2,110	93.00	90.80	LARGE	F	H	5/8	1-3/8	1,200
HTSZ-1300MQ	ZB95K5E	-	\$23,290	\$23,910	\$2,110	118.50	116.60	X-LARGE	J	H	7/8	1-5/8	1,550
HTSZ-1500MQ	ZB114K5E	-	\$23,460	\$24,020	\$2,400	138.50	136.60	X-LARGE	J	H	7/8	1-5/8	1,550
Scroll - Low Temperature - R-448A / R-407A													
-20° F Evap													
HTSZ-0200LQ	ZF06K4E	\$6,750	\$6,750	\$7,210	\$1,440	7.20	7.00	SMALL	A	B	1/2	7/8	400
HTSZ-0250LQ	ZF08K4E	\$6,950	\$6,950	\$7,390	\$1,440	9.20	8.50	SMALL	A	B	1/2	7/8	400
HTSZ-0300LQ	ZF09K4E	\$8,900	\$8,890	\$9,340	\$1,440	10.20	9.60	MEDIUM	B	C	1/2	7/8	650
HTSZ-0350LQ	ZF11K4E	\$8,430	\$8,420	\$8,880	\$1,440	12.80	12.00	MEDIUM	B	C	1/2	7/8	650
HTSZ-0400LQ	ZF13K4E	\$8,740	\$8,730	\$9,180	\$1,440	14.70	13.40	MEDIUM	B	C	1/2	7/8	650
HTSZ-0500LQ	ZF15K4E	\$9,140	\$9,130	\$9,580	\$1,570	18.10	16.60	MEDIUM	B	C	5/8	7/8	650
HTSZ-0600LQ	ZF18K4E	-	\$9,220	\$9,670	\$1,570	22.10	19.80	MEDIUM	B	C	5/8	7/8	650
HTSZ-0750LQ	ZF25K4E	-	\$12,450	\$12,900	\$1,570	26.00	24.60	MEDIUM	B	C	5/8	1-3/8	650
HTSZ-1000LQ	ZF34K4E	-	\$20,790	\$21,380	\$2,120	35.60	35.15	LARGE	E	F	5/8	1-3/8	1,200

* H-SERIES OPTIONS PAGE HAS STANDARD FEATURES AND BASIC OPTIONS LIST. USE H-SERIES SOFTWARE FOR ADDITIONAL CUSTOMIZATION.

** ORDERS FOR CONDENSING UNITS MUST INCLUDE THE FULL MODEL NUMBER INCLUDING CONDENSER AND RECEIVER "HTSZ-0200MSAB"

CABINET SIZE	L	W	H
Small	41.8	32.3	24.5
Medium	48.0	34.1	41.9
Large	84.0	35.1	41.9
X-Large	99.0	35.0	54.4

Standard Options on HTSZ units include sealed liquid drier, pumpdown switch, time clock and crating.

RECEIVER SIZE	CAPACITY (LBS @ 90%)				LIST PRICE TO UPGRADE TO RECEIVER SIZE	MINIMUM CABINET SIZE
	R-22	R-404A/507	R-407A	R-448A		
A 6 X 12	12.8	11.1	12.2	11.6	-	SMALL
B 6 X 18	19.2	16.7	18.3	17.4	\$210	SMALL
C 6 X 23	24.6	21.4	23.4	22.3	\$50	MEDIUM
D 6 X 30	32.0	27.9	30.4	29.0	\$40	MEDIUM
E 8-5/8 X 30	62.0	53.9	59.0	56.2	\$440	MEDIUM
F 10-3/4 X 30	94.6	82.3	90.0	85.8	\$250	LARGE
H 12-3/4 X 30	115.0	100.1	109.4	104.3	\$720	LARGE

* CALCULATE COST FOR LARGER RECEIVER - ADD COST FOR EACH SIZE CHANGE (EXAMPLE - INCREASE SIZE FROM A TO C COST IS \$190 + \$50 = \$240)

This product line does not have AWEF numbers and may only be applied with refrigeration loads that are not regulated by the DOE/NRCAN.

Prices, product availability, and specifications are subject to change without notice.



H-SERIES LEGACY PRODUCT DESCRIPTION

Version: July 2020

HTSB - H-SERIES LEGACY BITZER ECOLINE CONDENSING UNITS

UNIT MODEL	COMPRESSOR MODEL	LIST PRICE			4 Year Extended Compressor Warranty	CAPACITY (MBH)		TECHNICAL SPECIFICATION					SHIP WGT (LBS)
		208/1/60 D	208/3/60 K	460/3/60 M		@ 95° F Ambient		Cabinet Size	Cond Size	Rcvr Size	Connections		
						+25 F Evap	-20 F Evap				Liquid	Suction	
Bitzer Ecoline - Medium Temperature - R-404A													
HTSE-0050MS	2KES-05	-	\$7,540	\$7,990	\$1,020	10.06	-	SMALL	A	B	1/2	5/8	400
HTSE-0070MS	2JES-07	-	\$7,630	\$8,080	\$1,020	13.07	-	SMALL	A	B	1/2	5/8	400
HTSB-0100MS(1)	2HES-1	-	\$7,810	\$8,260	\$1,020	15.69	-	SMALL	A	B	1/2	5/8	400
HTSB-0150MS(1)	2FES-2	-	\$9,590	\$10,040	\$1,020	25.27	-	MEDIUM	B	D	1/2	5/8	550
HTSB-0200MS(1)	2EES-2	-	\$10,630	\$10,970	\$1,410	31.68	-	MEDIUM	B	D	1/2	7/8	550
HTSB-0220MS(1)	2DES-2	-	\$10,770	\$11,220	\$1,410	36.83	-	MEDIUM	B	D	5/8	7/8	550
HTSB-0300MS(1)	2CES-3	-	\$10,950	\$11,400	\$1,410	43.75	-	MEDIUM	B	D	5/8	7/8	550
HTSB-0400MS(1)	4FES-3	-	\$13,090	\$13,600	\$1,970	48.00	-	MEDIUM	D	E	5/8	7/8	550
HTSB-0500MS(1)	4EES-4	-	\$16,300	\$16,930	\$1,970	62.02	-	LARGE	E	F	5/8	1-1/8	1,250
HTSB-0600MS(1)	4DES-5	-	\$17,570	\$18,200	\$1,970	71.72	-	LARGE	E	H	5/8	1-1/8	1,250
HTSB-0650MS(1)	4CES-6	-	\$19,140	\$19,730	\$1,970	86.62	-	LARGE	F	H	7/8	1-1/8	1,250
HTSB-0700MS(1)	4VES-7	-	\$19,400	\$20,000	\$2,680	89.29	-	LARGE	F	H	7/8	1-1/8	1,250
HTSB-0900MS(1)	4TES-9	-	\$24,130	\$24,850	\$2,680	113.14	-	X-LARGE	J	H	7/8	1-5/8	1,575
HTSB-1000MS(1)	4PES-12	-	\$24,430	\$25,050	\$2,680	126.41	-	X-LARGE	J	H	7/8	1-5/8	1,575
HTSB-1200MS(1)	4NES-14	-	\$25,140	\$25,730	\$2,680	144.57	-	X-LARGE	J	H	5/8	1-5/8	1,575
Bitzer Ecoline - Low Temperature - R-404A													
HTSE-0050LS	2KES-05	-	\$7,540	\$7,990	\$1,020	-	3.11	SMALL	A	B	1/2	5/8	400
HTSE-0070LS	2JES-07	-	\$7,630	\$8,080	\$1,020	-	4.41	SMALL	A	B	1/2	5/8	400
HTSB-0100LS	2HES-1	-	\$7,810	\$8,260	\$1,020	-	5.56	SMALL	A	B	1/2	5/8	400
HTSB-0150LS	2FES-2	-	\$7,850	\$8,300	\$1,020	-	7.92	SMALL	A	B	1/2	5/8	400
HTSB-0200LS	2EES-2	-	\$8,780	\$9,240	\$1,410	-	9.97	SMALL	A	B	1/2	7/8	400
HTSB-0220LS	2DES-2	-	\$10,730	\$11,180	\$1,410	-	13.32	MEDIUM	B	C	1/2	7/8	550
HTSB-0300LS	2CES-3	-	\$10,880	\$11,330	\$1,410	-	16.49	MEDIUM	B	C	1/2	7/8	550
HTSB-0400LS	4FES-3	-	\$11,760	\$12,210	\$1,970	-	17.38	MEDIUM	B	D	5/8	7/8	550
HTSB-0500LS	4EES-4	-	\$11,970	\$12,450	\$1,970	-	21.50	MEDIUM	B	D	5/8	1-1/8	550
HTSB-0600LS	4DES-5	-	\$13,800	\$14,310	\$1,970	-	25.70	MEDIUM	D	E	5/8	1-1/8	550
HTSB-0650LS	4CES-6	-	\$15,220	\$15,670	\$1,970	-	29.90	MEDIUM	D	E	5/8	1-1/8	550
HTSB-0700LS	4VES-7	-	\$15,470	\$15,940	\$2,680	-	29.40	MEDIUM	D	E	5/8	1-1/8	550
HTSB-0900LS	4TES-9	-	\$18,690	\$19,280	\$2,680	-	37.33	LARGE	E	F	5/8	1-3/8	1,250
HTSB-1000LS	4PES-12	-	\$19,000	\$19,490	\$2,680	-	40.44	LARGE	E	F	7/8	1-5/8	1,250
HTSB-1200LS	4NES-14	-	\$19,710	\$20,170	\$2,680	-	49.71	LARGE	E	F	7/8	1-5/8	1,250
HTSB-1400LS	4JE-15	-	\$22,200	\$22,480	\$3,880	-	57.70	LARGE	F	H	7/8	1-5/8	1,250
HTSB-1600LS	4HE-18	-	\$27,400	\$27,540	\$3,880	-	71.94	X-LARGE	J	H	7/8	2-1/8	1,250
Bitzer Ecoline - Medium Temperature - R-448A / R-407A													
HTSE-0050MQ	2KES-05	-	\$7,540	\$7,990	\$1,020	10.42	10.82	SMALL	A	B	1/2	5/8	400
HTSE-0070MQ	2JES-07	-	\$7,630	\$8,080	\$1,020	13.29	13.85	SMALL	A	B	1/2	5/8	400
HTSB-0100MQ(1)	2HES-1	-	\$7,810	\$8,260	\$1,020	16.27	17.02	SMALL	A	B	1/2	5/8	550
HTSB-0150MQ(1)	2FES-2	-	\$9,590	\$10,040	\$1,020	26.45	27.37	MEDIUM	B	D	1/2	5/8	550
HTSB-0200MQ(1)	2EES-2	-	\$10,630	\$10,970	\$1,410	32.29	30.99	MEDIUM	B	D	1/2	7/8	550
HTSB-0220MQ(1)	2DES-2	-	\$10,770	\$11,220	\$1,410	37.73	36.20	MEDIUM	B	D	1/2	7/8	550
HTSB-0300MQ(1)	2CES-3	-	\$10,950	\$11,400	\$1,410	45.01	43.32	MEDIUM	B	D	5/8	7/8	550
HTSB-0400MQ(1)	4FES-3	-	\$13,090	\$13,600	\$1,970	49.60	48.70	MEDIUM	D	E	5/8	7/8	550
HTSB-0500MQ(1)	4EES-4	-	\$16,300	\$16,930	\$1,970	63.50	60.96	LARGE	E	F	5/8	1-1/8	1,250
HTSB-0600MQ(1)	4DES-5	-	\$17,570	\$18,200	\$1,970	72.82	69.93	LARGE	E	H	5/8	1-1/8	1,250
HTSB-0650MQ(1)	4CES-6	-	\$19,140	\$19,730	\$1,970	89.22	85.84	LARGE	F	H	7/8	1-1/8	1,250
HTSB-0700MQ(1)	4VES-7	-	\$19,400	\$20,000	\$2,680	91.79	87.99	LARGE	F	H	7/8	1-1/8	1,250
HTSB-0900MQ(1)	4TES-9	-	\$24,130	\$24,850	\$2,680	115.92	111.65	X-LARGE	J	H	7/8	1-3/8	1,575
HTSB-1000MQ(1)	4PES-12	-	\$24,430	\$25,050	\$2,680	129.53	124.60	X-LARGE	J	H	7/8	1-5/8	1,575
HTSB-1200MQ(1)	4NES-14	-	\$25,140	\$25,730	\$2,680	148.40	143.00	X-LARGE	J	H	5/8	1-5/8	1,575
Bitzer Ecoline - Low Temperature - R-448A / R-407A													
HTSB-0050LQ	2KES-05	-	\$7,540	\$7,990	\$1,020	2.91	3.12	SMALL	A	B	1/2	5/8	400
HTSB-0070LQ	2JES-07	-	\$7,630	\$8,080	\$1,020	4.01	4.32	SMALL	A	B	1/2	5/8	400
HTSB-0100LQ	2HES-1	-	\$7,810	\$8,260	\$1,020	5.13	5.53	SMALL	A	B	1/2	5/8	400
HTSB-0150LQ	2FES-2	-	\$7,850	\$8,300	\$1,020	7.42	8.08	SMALL	A	B	1/2	5/8	400
HTSB-0200LQ	2EES-2	-	\$8,780	\$9,240	\$1,410	8.98	8.38	SMALL	A	B	1/2	7/8	400
HTSB-0220LQ	2DES-2	-	\$10,730	\$11,180	\$1,410	12.29	11.32	MEDIUM	B	C	1/2	7/8	550
HTSB-0300LQ	2CES-3	-	\$10,910	\$11,360	\$1,410	15.26	14.15	MEDIUM	B	C	1/2	7/8	550
HTSB-0400LQ	4FES-3	-	\$12,320	\$12,760	\$1,410	15.83	15.64	MEDIUM	B	D	5/8	7/8	550
HTSB-0500LQ	4EES-4	-	\$12,530	\$12,980	\$1,410	19.49	18.41	MEDIUM	B	D	5/8	1-1/8	550
HTSB-0600LQ	4DES-5	-	\$14,360	\$14,870	\$1,410	22.10	20.80	MEDIUM	D	E	5/8	1-1/8	550
HTSB-0650LQ	4CES-6	-	\$15,770	\$16,230	\$1,970	27.90	26.70	MEDIUM	D	E	5/8	1-1/8	550
HTSB-0700LQ	4VES-7	-	\$15,970	\$16,440	\$1,970	27.00	25.30	MEDIUM	D	E	5/8	1-1/8	550
HTSB-0900LQ	4TES-9	-	\$19,200	\$19,780	\$2,680	35.51	33.44	LARGE	E	F	5/8	1-3/8	1,250
HTSB-1000LQ	4PES-12	-	\$19,500	\$19,990	\$2,680	38.15	35.86	LARGE	E	F	7/8	1-5/8	1,250
HTSB-1200LQ	4NES-14	-	\$20,260	\$20,720	\$2,680	47.35	42.84	LARGE	E	F	7/8	1-5/8	1,250
HTSB-1400LQ	4JE-15	-	\$22,760	\$23,020	\$3,880	54.40	45.40	LARGE	F	H	7/8	1-5/8	1,250
HTSB-1600LQ	4HE-18	-	\$27,980	\$28,110	\$3,880	68.96	60.38	X-LARGE	J	H	7/8	2-1/8	1,575

* H-SERIES OPTIONS PAGE HAS STANDARD FEATURES AND BASIC OPTIONS LIST. USE H-SERIES SOFTWARE FOR ADDITIONAL CUSTOMIZATION.

** ORDERS FOR CONDENSING UNITS MUST INCLUDE THE FULL MODEL NUMBER INCLUDING CONDENSER AND RECEIVER "HTSB-0200MSBD"

Refer to cabinet and receiver information on previous page.

- (1) Maximum +32°F suction operation for motor 2 compressors shown. Request COD for motor 1 compressor where operation may exceed +32°F or for more efficient medium temperature operation.
- (2) Selection of these medium temperature models will have condenser temperature differences over 20°F due to the available size of the condenser. See Krack C series models for selections with larger condensers for use in ambient temperature above 95°F.

This product line does not have AWEF numbers and may only be applied with refrigeration loads that are not regulated by the DOE/NRCAN.

H-SERIES LEGACY PRODUCT DESCRIPTION

Version: **July 2020**

H-SERIES LEGACY OPTIONS (Excludes HTST)

APPLIES TO H MODEL CONDENSING UNITS EQUIPPED WITH BITZER SEMI-HERMETIC AND COPELAND DISCUS, SCROLL AND SEMI-HERMETIC COMPRESSORS.

Standard Options

- Galvanized Steel Outdoor Housing
- Manual Re-Set High Pressure Control (Encapsulated)
- Adjustable Auto-Reset Low Pressure Control
- Oil Pressure Failure Control (Discus compressors only)
- Fixed Head Pressure Control Valve
- Crankcase Heater
- Vertical Receiver with Fusible Plug
- Compressor Contactor and Fuses
- Control Circuit with Fuses
- Sealed Liquid Line Drier and Sightglass
- Pump Down Switch
- UL Listed
- Time Clock for Defrost Scheduling
- Crating for Shipping Protection

Available Options (Shown Below)

- Sealed Suction Filter
- Replaceable Core Suction Filter
- Suction Accumulator
- Oil Separator
- Liquid Line Solenoid
- Fused Disconnect
- Phase Monitor
- Fan Cycling
- Electric Defrost Kits
- Electrofin Condenser Coating
- Copper Condenser Fins

Additional Options Available from Software

- Stackable Indoor Option
- Oversize Condenser
- Oversize Receiver
- Oil Regulator
- Adjustable Head Pressure Control
- Relief Valve Instead of Fusible Plug
- Oil Level Regulator (with Oil Separator)
- Compressor Unloader (Discus or Bitzer)
- Discharge Check Valve
- Receiver Heat and Insulation
- Suction Line Insulation
- Breaker Instead of Fuses
- Heavy-Duty Base with Horizontal Receiver
- Non-Fused Disconnect
- Replaceable Core Drier
- Hail Guard

Suction Filter			Suction Accumulator		Oil Separator		Liquid Line Solenoid Valve	
Suction Connection	Non Replaceable List Price	Replaceable Core List Price	Suction Connection	List Price	Discharge Connection	List Price	Liquid Connection	List Price
5/8	\$90	\$260	5/8	\$360	1/2 (S)	\$1,180	1/2	\$250
7/8	\$90	\$220	7/8	\$360	5/8 (M)	\$1,210	5/8	\$250
1-1/8	\$90	\$220	1 1/8	\$410	7/8 (L)	\$1,630	7/8	\$250
1-3/8	\$140	\$230	1 3/8	\$480	1 1/8 (L)	\$1,810		
1-5/8	\$140	\$240	1 5/8	\$550				
2-1/8	\$330	\$260	2 1/8	\$680				

Defrost Kits*	Price List
Defrost Clock	\$380
Elec Def Kit- E2 w Defrost Clock	\$1,910
Elec Def Kit- E3 w Defrost Clock	\$2,350
Elec Def Kit- E4 w Defrost Clock	\$3,660

1 phase, <12A fan motor, <48A heater
 3 phase, <12A fan motor, <48A heater
 3 phase, <12A fan motor, (2)<48A heater

Heat & Insulate Receiver	
Receiver Size	List Price
A, B, C, D	\$360
E, F	\$360
G, H	\$360

* Must specify evaporator motor and heater voltage and amperage.

** Deduct Defrost Clock from standard units before adding Electric Defrost Kits.

Fused Disconnect (loose)		Phase Loss Monitor		Fan Cycling (per fan)**		Fan Cycling	
Amp/Poles/Voltage	List Price	Voltage	List Price	Cycle	List Price	Cond Size	# of Fans
30A 3P 240 V	\$530	208 - 460 V	\$300	1 Step	\$290	A	1**
60A 3P 240 V	\$760	575 V	\$300	2 Step	\$580	B	1**
100A 3P 240 V	\$1,110			3 Step	\$860	C	2
200A 3P 240 V	\$2,130			4 Step	\$1,150	D	2
30A 3P 600 V	\$780			5 Step	\$1,450	E	4
60A 3P 600 V	\$760					F	4
100A 3P 600 V	\$1,480					J	6
200A 3P 600 V	\$2,130						

** FAN CYCLING IS AVAILABLE ON 2 THROUGH 6 FAN UNITS
 THE LEAD FAN ON ALL UNITS WILL NOT BE CYCLED OFF

Condenser Size	Condenser Coil Protection Adder	
	Electrofin	Copper Fin
A	\$590	COD
B	\$380	COD
C	\$510	COD
D	\$900	COD
E	\$2,390	COD
F	\$2,980	COD
J	\$3,930	COD

FOR OTHER OPTIONS AND CONFIGURATIONS, CONTACT YOUR APPLICATION OR SALES ENGINEER.

Prices, product availability, and specifications are subject to change without notice.

This product line does not have AWEF numbers and may only be applied with refrigeration loads that are not regulated by the DOE/NRCan.



HIGH EFFICIENCY H-SERIES MODEL KEY

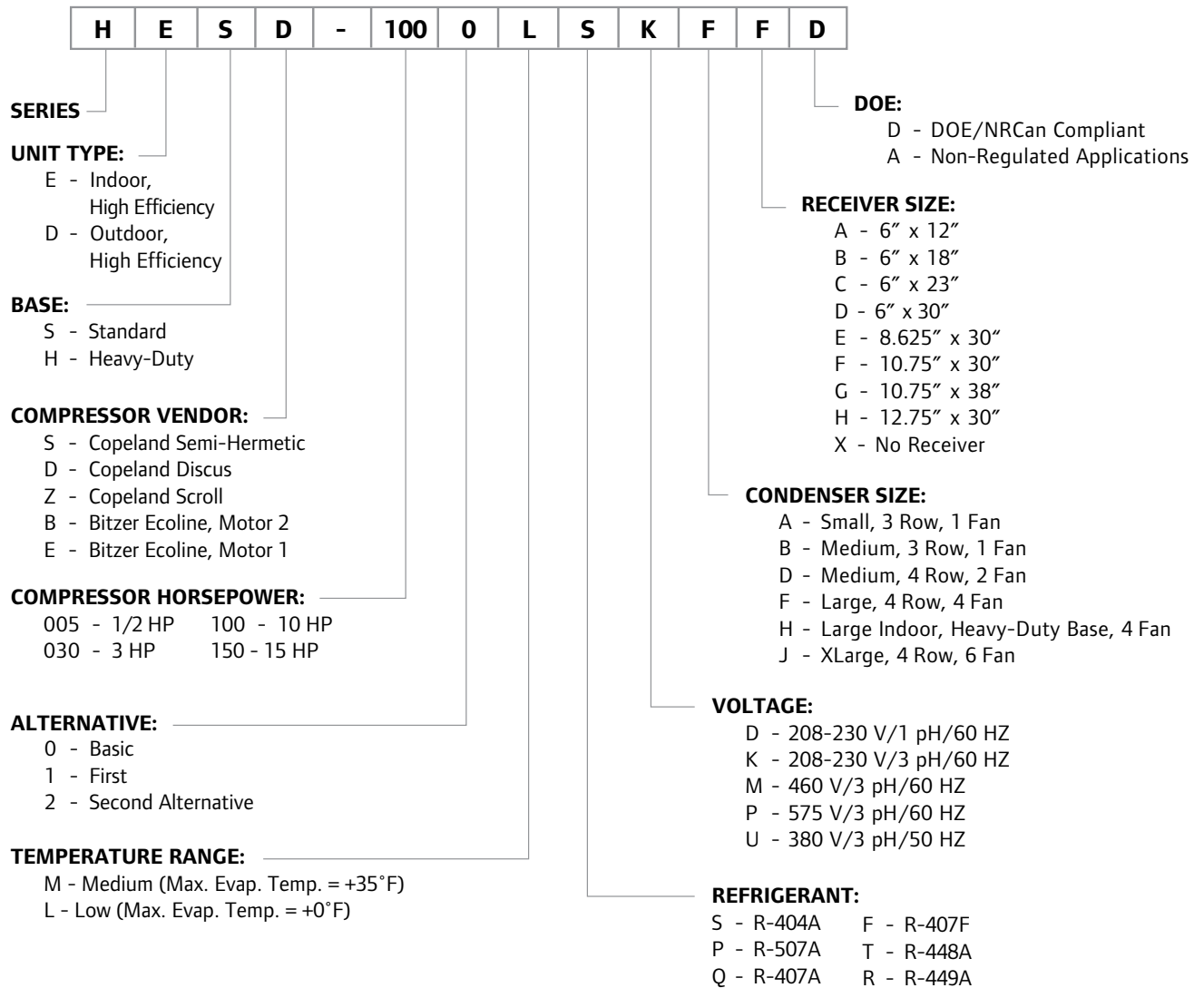

NOTE: Units are ordered refrigerant specific (i.e. "S" for R-404A) but will include other refrigerants that can also be used on the data plate.

This produce line includes AWEF values and can be applied with refrigeration loads regulated by DOE/NRCan. See the technical bulletin for published AWEF values.



HIGH EFFICIENCY H-SERIES PRODUCT DESCRIPTION

Version: July 2020

HDSZ - HIGH EFFICIENCY H-SERIES COPELAND SCROLL CONDENSING UNITS

UNIT MODEL	COMPRESSOR MODEL	LIST PRICE			4 Year Extended Compressor Warranty	TECHNICAL SPECIFICATION				SHIP WGT (LBS)
		208/1/60 D	208/3/60 K	460/3/60 M		Condenser & Cabinet Size	Rcvr Size	Connections		
								Liquid	Suction	
Scroll - Medium Temperature R-407F										
HDSZ-0200MF#BC-D	ZB15KCE	\$8,650	\$8,650	\$9,100	\$1,080	B / Medium	C	1/2	7/8	650
HDSZ-0200MF#DE-D	ZB15KCE	\$10,700	\$10,690	\$11,210	\$1,080	D / Medium	E	1/2	7/8	650
HDSZ-0250MF#BC-D	ZB19KCE	\$7,650	\$7,640	\$8,090	\$1,080	B / Medium	C	1/2	7/8	650
HDSZ-0250MF#DE-D	ZB19KCE	\$9,690	\$9,690	\$10,200	\$1,080	D / Medium	E	1/2	7/8	650
HDSZ-0300MF#BC-D	ZB21KCE	\$8,130	\$8,120	\$8,570	\$1,080	B / Medium	C	1/2	7/8	650
HDSZ-0300MF#DE-D	ZB21KCE	\$10,170	\$10,170	\$10,680	\$1,080	D / Medium	E	1/2	7/8	650
HDSZ-0350MF#BC-D	ZB26KCE	\$8,200	\$8,200	\$8,650	\$1,080	B / Medium	C	1/2	7/8	650
HDSZ-0350MF#DE-D	ZB26KCE	\$10,250	\$10,240	\$10,760	\$1,080	D / Medium	E	1/2	7/8	650
HDSZ-0400MF#BC-D	ZB30KCE	\$8,580	\$8,580	\$9,030	\$1,080	B / Medium	C	5/8	7/8	650
HDSZ-0400MF#DE-D	ZB30KCE	\$10,620	\$10,620	\$11,140	\$1,080	D / Medium	E	5/8	7/8	650
HDSZ-0500MF#DE-D	ZB38KCE	\$10,620	\$10,620	\$11,140	\$1,080	D / Medium	E	5/8	7/8	650
HDSZ-0500MF#FF-D	ZB38KCE	\$13,650	\$13,640	\$14,290	\$1,080	F / Large	F	5/8	7/8	1,200
HDSZ-0600MF#FF-D	ZB48KCE	NA	\$14,190	\$14,840	\$1,080	F / Large	F	5/8	7/8	1,200
HDSZ-0600MF#JH-D	ZB48KCE	NA	\$19,450	\$20,220	\$1,080	J / X-Large	H	5/8	7/8	1,550
HDSZ-0750MF#FF-D	ZB58K5E	NA	\$16,540	\$16,512	\$2,110	F / Large	F	5/8	1-3/8	1,200
HDSZ-0750MF#JH-D	ZB58K5E	NA	\$21,800	\$22,560	\$2,110	J / X-Large	H	5/8	1-3/8	1,550
HDSZ-1000MF#FF-D	ZB76K5E	NA	\$18,820	\$19,330	\$2,110	F / Large	F	5/8	1-3/8	1,200
HDSZ-1000MF#JH-D	ZB76K5E	NA	\$24,080	\$24,740	\$2,110	J / X-Large	H	5/8	1-3/8	1,550
HDSZ-1300MF#JH-D	ZB95K5E	NA	\$23,960	\$24,590	\$2,110	J / X-Large	H	7/8	1-3/8	1,550
HDSZ-1500MF#JH-A	ZB114K5E	NA	\$24,250	\$24,670	\$2,400	J / X-Large	H	7/8	1-3/8	1,550

UNIT MODEL	COMPRESSOR MODEL	LIST PRICE			4 Year Extended Compressor Warranty	TECHNICAL SPECIFICATION				SHIP WGT (LBS)
		208/1/60 D	208/3/60 K	460/3/60 M		Condenser & Cabinet Size	Rcvr Size	Connections		
								Liquid	Suction	
Scroll - Low Temperature R-407F										
HDSZ-0200LF#AB-A	ZF06K4E	\$7,440	\$7,430	\$7,890	\$1,440	A / Small	B	1/2	7/8	400
HDSZ-0200LF#BC-D	ZF06K4E	\$8,900	\$8,890	\$9,440	\$1,440	B / Medium	C	1/2	7/8	650
HDSZ-0250LF#BC-D	ZF08K4E	\$9,250	\$9,250	\$9,700	\$1,440	B / Medium	C	1/2	7/8	650
HDSZ-0250LF#DE-A	ZF08K4E	\$11,070	\$11,070	\$11,590	\$1,440	D / Medium	E	1/2	7/8	650
HDSZ-0300LF#AB-D	ZF09K4E	\$7,920	\$7,920	\$8,470	\$1,440	A / Small	B	1/2	7/8	650
HDSZ-0300LF#BC-D	ZF09K4E	\$9,330	\$9,330	\$9,880	\$1,440	B / Medium	C	1/2	7/8	650
HDSZ-0350LF#BC-D	ZF11K4E	\$8,860	\$8,860	\$9,420	\$1,440	B / Medium	C	1/2	7/8	650
HDSZ-0350LF#DE-D	ZF11K4E	\$10,510	\$10,510	\$11,120	\$1,440	D / Medium	E	1/2	7/8	650
HDSZ-0400LF#BC-D	ZF13K4E	\$9,170	\$9,170	\$9,720	\$1,440	B / Medium	C	1/2	7/8	650
HDSZ-0400LF#DE-D	ZF13K4E	\$10,820	\$10,810	\$11,430	\$1,440	D / Medium	E	1/2	7/8	650
HDSZ-0500LF#BC-D	ZF15K4E	\$9,570	\$9,570	\$10,120	\$1,570	B / Medium	C	1/2	7/8	650
HDSZ-0500LF#DE-D	ZF15K4E	\$11,220	\$11,210	\$11,830	\$1,570	D / Medium	E	1/2	7/8	650
HDSZ-0600LF#BC-D	ZF18K4E	NA	\$9,580	\$10,130	\$1,570	B / Medium	C	5/8	7/8	650
HDSZ-0600LF#DE-D	ZF18K4E	NA	\$11,220	\$11,840	\$1,570	D / Medium	E	5/8	7/8	650
HDSZ-0750LF#DE-A	ZF25K4E	NA	\$14,830	\$15,350	\$1,570	D / Medium	E	5/8	1-3/8	650
HDSZ-0750LF#FF-D	ZF25K4E	NA	\$17,710	\$18,460	\$1,570	F / Large	F	5/8	1-3/8	1,200
HDSZ-1000LF#DE-A	ZF34K5E	NA	\$18,430	\$18,840	\$2,120	D / Medium	E	5/8	1-3/8	650
HDSZ-1000LF#FF-D	ZF34K5E	NA	\$21,700	\$22,240	\$2,120	F / Large	F	5/8	1-3/8	1,200

* H-SERIES OPTIONS PAGE LISTS OPTIONS. USE H-SERIES SOFTWARE FOR ADDITIONAL CUSTOMIZATION.

** ORDERS MUST INCLUDE THE FULL MODEL NUMBER INCLUDING CONDENSER AND RECEIVER "HDSZ-0200MFKAB"

Standard Options on HDSZ units include sealed liquid drier, pumpdown switch, time clock and crating.



HIGH EFFICIENCY H-SERIES PRODUCT DESCRIPTION

Version: July 2020

HDSZ - HIGH EFFICIENCY H-SERIES COPELAND SCROLL CONDENSING UNITS

UNIT MODEL	COMPRESSOR MODEL	LIST PRICE			4 Year Extended Compressor Warranty	TECHNICAL SPECIFICATION				SHIP WGT (LBS)
		208/1/60 D	208/3/60 K	460/3/60 M		Condenser & Cabinet Size	Rcvr Size	Connections		
								Liquid	Suction	
Scroll - Medium Temperature R-507A										
HDSZ-0200MP#BC-D	ZB15KCE	\$8,650	\$8,650	\$9,100	\$1,080	B / Medium	C	1/2	7/8	650
HDSZ-0200MP#DE-D	ZB15KCE	\$10,700	\$10,690	\$11,210	\$1,080	D / Medium	E	1/2	7/8	650
HDSZ-0250MP#BC-D	ZB19KCE	\$7,650	\$7,640	\$8,090	\$1,080	B / Medium	C	1/2	7/8	650
HDSZ-0250MP#DE-D	ZB19KCE	\$9,690	\$9,690	\$10,200	\$1,080	D / Medium	E	1/2	7/8	650
HDSZ-0300MP#BC-D	ZB21KCE	\$8,130	\$8,120	\$8,570	\$1,080	B / Medium	C	1/2	7/8	650
HDSZ-0300MP#DE-D	ZB21KCE	\$10,170	\$10,170	\$10,680	\$1,080	D / Medium	E	1/2	7/8	650
HDSZ-0350MP#BC-A	ZB26KCE	\$8,200	\$8,200	\$8,650	\$1,080	B / Medium	C	1/2	7/8	650
HDSZ-0350MP#DE-D	ZB26KCE	\$10,250	\$10,240	\$10,760	\$1,080	D / Medium	E	1/2	7/8	650
HDSZ-0400MP#BC-D	ZB30KCE	\$8,580	\$8,580	\$9,030	\$1,080	B / Medium	C	5/8	7/8	650
HDSZ-0400MP#DE-D	ZB30KCE	\$10,620	\$10,620	\$11,140	\$1,080	D / Medium	E	5/8	7/8	650
HDSZ-0500MP#DE-D	ZB38KCE	\$10,620	\$10,620	\$11,140	\$1,080	D / Medium	E	5/8	7/8	650
HDSZ-0500MP#FF-D	ZB38KCE	\$13,650	\$13,640	\$14,290	\$1,080	F / Large	F	5/8	7/8	1,200
HDSZ-0600MP#FF-D	ZB48KCE	NA	\$14,190	\$14,840	\$1,080	F / Large	F	5/8	7/8	1,200
HDSZ-0600MP#JH-D	ZB48KCE	NA	\$19,450	\$20,220	\$1,080	J / X-Large	H	5/8	7/8	1,550
HDSZ-0750MP#FF-D	ZB58K5E	NA	\$16,540	\$16,512	\$2,110	F / Large	F	5/8	1-3/8	1,200
HDSZ-0750MP#JH-D	ZB58K5E	NA	\$21,800	\$22,560	\$2,110	J / X-Large	H	5/8	1-3/8	1,550
HDSZ-1000MP#FF-D	ZB76K5E	NA	\$18,820	\$19,330	\$2,110	F / Large	F	5/8	1-3/8	1,200
HDSZ-1000MP#JH-D	ZB76K5E	NA	\$24,080	\$24,740	\$2,110	J / X-Large	H	5/8	1-3/8	1,550
HDSZ-1300MP#JH-D	ZB95K5E	NA	\$23,960	\$24,590	\$2,110	J / X-Large	H	7/8	1-3/8	1,550
HDSZ-1500MP#JH-D	ZB114K5E	NA	\$24,250	\$24,670	\$2,400	J / X-Large	H	7/8	1-3/8	1,550

UNIT MODEL	COMPRESSOR MODEL	LIST PRICE			4 Year Extended Compressor Warranty	TECHNICAL SPECIFICATION				SHIP WGT (LBS)
		208/1/60 D	208/3/60 K	460/3/60 M		Condenser & Cabinet Size	Rcvr Size	Connections		
								Liquid	Suction	
Scroll - Low Temperature R-507A										
HDSZ-0200LP#AB-A	ZF06K4E	\$7,440	\$7,430	\$7,890	\$1,440	A / Small	B	1/2	7/8	400
HDSZ-0200LP#BC-D	ZF06K4E	\$8,900	\$8,890	\$9,440	\$1,440	B / Medium	C	1/2	7/8	650
HDSZ-0250LP#BC-D	ZF08K4E	\$9,250	\$9,250	\$9,700	\$1,440	B / Medium	C	1/2	7/8	650
HDSZ-0250LP#DE-D	ZF08K4E	\$11,070	\$11,070	\$11,590	\$1,440	D / Medium	E	1/2	7/8	650
HDSZ-0300LP#AB-D	ZF09K4E	\$7,920	\$7,920	\$8,470	\$1,440	A / Small	B	1/2	7/8	650
HDSZ-0300LP#BC-D	ZF09K4E	\$9,330	\$9,330	\$9,880	\$1,440	B / Medium	C	1/2	7/8	650
HDSZ-0350LP#BC-D	ZF11K4E	\$8,860	\$8,860	\$9,420	\$1,440	B / Medium	C	1/2	7/8	650
HDSZ-0350LP#DE-D	ZF11K4E	\$10,510	\$10,510	\$11,120	\$1,440	D / Medium	E	1/2	7/8	650
HDSZ-0400LP#BC-D	ZF13K4E	\$9,170	\$9,170	\$9,720	\$1,440	B / Medium	C	1/2	7/8	650
HDSZ-0400LP#DE-D	ZF13K4E	\$10,820	\$10,810	\$11,430	\$1,440	D / Medium	E	1/2	7/8	650
HDSZ-0500LP#BC-D	ZF15K4E	\$9,570	\$9,570	\$10,120	\$1,570	B / Medium	C	1/2	7/8	650
HDSZ-0500LP#DE-D	ZF15K4E	\$11,220	\$11,210	\$11,830	\$1,570	D / Medium	E	1/2	7/8	650
HDSZ-0600LP#BC-D	ZF18K4E	NA	\$9,580	\$10,130	\$1,570	B / Medium	C	5/8	7/8	650
HDSZ-0600LP#DE-D	ZF18K4E	NA	\$11,220	\$11,840	\$1,570	D / Medium	E	5/8	7/8	650
HDSZ-0750LP#DE-D	ZF25K4E	NA	\$14,830	\$15,350	\$1,570	D / Medium	E	5/8	1-3/8	650
HDSZ-0750LP#FF-D	ZF25K4E	NA	\$17,710	\$18,460	\$1,570	F / Large	F	5/8	1-3/8	1,200
HDSZ-1000LP#DE-D	ZF34K5E	NA	\$18,430	\$18,840	\$2,120	D / Medium	E	5/8	1-3/8	650
HDSZ-1000LP#FF-D	ZF34K5E	NA	\$21,700	\$22,240	\$2,120	F / Large	F	5/8	1-3/8	1,200

* H-SERIES OPTIONS PAGE LISTS OPTIONS. USE H-SERIES SOFTWARE FOR ADDITIONAL CUSTOMIZATION.

** ORDERS MUST INCLUDE THE FULL MODEL NUMBER INCLUDING CONDENSER AND RECEIVER "HDSZ-0200MPKAB"

Standard Options on HDSZ units include sealed liquid drier, pumpdown switch, time clock and crating.



HIGH EFFICIENCY H-SERIES PRODUCT DESCRIPTION

Version: July 2020

HDSZ - HIGH EFFICIENCY H-SERIES COPELAND SCROLL CONDENSING UNITS

UNIT MODEL	COMPRESSOR MODEL	LIST PRICE			4 Year Extended Compressor Warranty	TECHNICAL SPECIFICATION				SHIP WGT (LBS)
		208/1/60 D	208/3/60 K	460/3/60 M		Condenser & Cabinet Size	Rcvr Size	Connections		
									Liquid	Suction
Scroll - Medium Temperature R-407A										
HDSZ-0200MQ#BC-D	ZB15KCE	\$8,650	\$8,650	\$9,100	\$1,080	B / Medium	C	1/2	7/8	650
HDSZ-0200MQ#DE-D	ZB15KCE	\$10,700	\$10,690	\$11,210	\$1,080	D / Medium	E	1/2	7/8	650
HDSZ-0250MQ#BC-D	ZB19KCE	\$7,650	\$7,640	\$8,090	\$1,080	B / Medium	C	1/2	7/8	650
HDSZ-0250MQ#DE-D	ZB19KCE	\$9,690	\$9,690	\$10,200	\$1,080	D / Medium	E	1/2	7/8	650
HDSZ-0300MQ#BC-D	ZB21KCE	\$8,130	\$8,120	\$8,570	\$1,080	B / Medium	C	1/2	7/8	650
HDSZ-0300MQ#DE-D	ZB21KCE	\$10,170	\$10,170	\$10,680	\$1,080	D / Medium	E	1/2	7/8	650
HDSZ-0350MQ#BC-D	ZB26KCE	\$8,200	\$8,200	\$8,650	\$1,080	B / Medium	C	1/2	7/8	650
HDSZ-0350MQ#DE-D	ZB26KCE	\$10,250	\$10,240	\$10,760	\$1,080	D / Medium	E	1/2	7/8	650
HDSZ-0400MQ#BC-D	ZB30KCE	\$8,580	\$8,580	\$9,030	\$1,080	B / Medium	C	5/8	7/8	650
HDSZ-0400MQ#DE-D	ZB30KCE	\$10,620	\$10,620	\$11,140	\$1,080	D / Medium	E	5/8	7/8	650
HDSZ-0500MQ#DE-D	ZB38KCE	\$10,620	\$10,620	\$11,140	\$1,080	D / Medium	E	5/8	7/8	650
HDSZ-0500MQ#FF-D	ZB38KCE	\$13,650	\$13,640	\$14,290	\$1,080	F / Large	F	5/8	7/8	1,200
HDSZ-0600MQ#FF-D	ZB48KCE	NA	\$14,190	\$14,840	\$1,080	F / Large	F	5/8	7/8	1,200
HDSZ-0600MQ#JH-D	ZB48KCE	NA	\$19,450	\$20,220	\$1,080	J / X-Large	H	5/8	7/8	1,550
HDSZ-0750MQ#FF-D	ZB58K5E	NA	\$16,540	\$16,512	\$2,110	F / Large	F	5/8	1-3/8	1,200
HDSZ-0750MQ#JH-D	ZB58K5E	NA	\$21,800	\$22,560	\$2,110	J / X-Large	H	5/8	1-3/8	1,550
HDSZ-1000MQ#FF-D	ZB76K5E	NA	\$18,820	\$19,330	\$2,110	F / Large	F	5/8	1-3/8	1,200
HDSZ-1000MQ#JH-D	ZB76K5E	NA	\$24,080	\$24,740	\$2,110	J / X-Large	H	5/8	1-3/8	1,550
HDSZ-1300MQ#JH-D	ZB95K5E	NA	\$23,960	\$24,590	\$2,110	J / X-Large	H	7/8	1-3/8	1,550
HDSZ-1500MQ#JH-A	ZB114K5E	NA	\$24,250	\$24,670	\$2,400	J / X-Large	H	7/8	1-3/8	1,550

UNIT MODEL	COMPRESSOR MODEL	LIST PRICE			4 Year Extended Compressor Warranty	TECHNICAL SPECIFICATION				SHIP WGT (LBS)
		208/1/60 D	208/3/60 K	460/3/60 M		Condenser & Cabinet Size	Rcvr Size	Connections		
									Liquid	Suction
Scroll - Low Temperature R-407A										
HDSZ-0200LQ#AB-A	ZF06K4E	\$7,440	\$7,430	\$7,890	\$1,440	A / Small	B	1/2	7/8	400
HDSZ-0200LQ#BC-D	ZF06K4E	\$8,900	\$8,890	\$9,440	\$1,440	B / Medium	C	1/2	7/8	650
HDSZ-0250LQ#BC-A	ZF08K4E	\$9,250	\$9,250	\$9,700	\$1,440	B / Medium	C	1/2	7/8	650
HDSZ-0250LQ#DE-A	ZF08K4E	\$11,070	\$11,070	\$11,590	\$1,440	D / Medium	E	1/2	7/8	650
HDSZ-0300LQ#AB-D	ZF09K4E	\$7,920	\$7,920	\$8,470	\$1,440	A / Small	B	1/2	7/8	650
HDSZ-0300LQ#BC-D	ZF09K4E	\$9,330	\$9,330	\$9,880	\$1,440	B / Medium	C	1/2	7/8	650
HDSZ-0350LQ#BC-D	ZF11K4E	\$8,860	\$8,860	\$9,420	\$1,440	B / Medium	C	1/2	7/8	650
HDSZ-0350LQ#DE-D	ZF11K4E	\$10,510	\$10,510	\$11,120	\$1,440	D / Medium	E	1/2	7/8	650
HDSZ-0400LQ#BC-D	ZF13K4E	\$9,170	\$9,170	\$9,720	\$1,440	B / Medium	C	1/2	7/8	650
HDSZ-0400LQ#DE-D	ZF13K4E	\$10,820	\$10,810	\$11,430	\$1,440	D / Medium	E	1/2	7/8	650
HDSZ-0500LQ#BC-D	ZF15K4E	\$9,570	\$9,570	\$10,120	\$1,570	B / Medium	C	1/2	7/8	650
HDSZ-0500LQ#DE-D	ZF15K4E	\$11,220	\$11,210	\$11,830	\$1,570	D / Medium	E	1/2	7/8	650
HDSZ-0600LQ#BC-D	ZF18K4E	NA	\$9,580	\$10,130	\$1,570	B / Medium	C	5/8	7/8	650
HDSZ-0600LQ#DE-D	ZF18K4E	NA	\$11,220	\$11,840	\$1,570	D / Medium	E	5/8	7/8	650
HDSZ-0750LQ#DE-D	ZF25K4E	NA	\$14,830	\$15,350	\$1,570	D / Medium	E	5/8	1-3/8	650
HDSZ-0750LQ#FF-D	ZF25K4E	NA	\$17,710	\$18,460	\$1,570	F / Large	F	5/8	1-3/8	1,200
HDSZ-1000LQ#DE-A	ZF34K5E	NA	\$18,430	\$18,840	\$2,120	D / Medium	E	5/8	1-3/8	650
HDSZ-1000LQ#FF-D	ZF34K5E	NA	\$21,700	\$22,240	\$2,120	F / Large	F	5/8	1-3/8	1,200

* H-SERIES OPTIONS PAGE LISTS OPTIONS. USE H-SERIES SOFTWARE FOR ADDITIONAL CUSTOMIZATION.

** ORDERS MUST INCLUDE THE FULL MODEL NUMBER INCLUDING CONDENSER AND RECEIVER "HDSZ-0200MQKAB"

Standard Options on HDSZ units include sealed liquid drier, pumpdown switch, time clock and crating.



HIGH EFFICIENCY H-SERIES PRODUCT DESCRIPTION

Version: July 2020

HDSZ - HIGH EFFICIENCY H-SERIES COPELAND SCROLL CONDENSING UNITS

UNIT MODEL	COMPRESSOR MODEL	LIST PRICE			4 Year Extended Compressor Warranty	TECHNICAL SPECIFICATION				SHIP WGT (LBS)
		208/1/60 D	208/3/60 K	460/3/60 M		Condenser & Cabinet Size	Rcvr Size	Connections		
								Liquid	Suction	
Scroll - Medium Temperature R-449A										
HDSZ-0200MR#BC-D	ZB15KCE	\$8,650	\$8,650	\$9,100	\$1,080	B / Medium	C	1/2	7/8	650
HDSZ-0200MR#DE-D	ZB15KCE	\$10,700	\$10,690	\$11,210	\$1,080	D / Medium	E	1/2	7/8	650
HDSZ-0250MR#BC-D	ZB19KCE	\$7,650	\$7,640	\$8,090	\$1,080	B / Medium	C	1/2	7/8	650
HDSZ-0250MR#DE-D	ZB19KCE	\$9,690	\$9,690	\$10,200	\$1,080	D / Medium	E	1/2	7/8	650
HDSZ-0300MR#BC-D	ZB21KCE	\$8,130	\$8,120	\$8,570	\$1,080	B / Medium	C	1/2	7/8	650
HDSZ-0300MR#DE-D	ZB21KCE	\$10,170	\$10,170	\$10,680	\$1,080	D / Medium	E	1/2	7/8	650
HDSZ-0350MR#BC-A	ZB26KCE	\$8,200	\$8,200	\$8,650	\$1,080	B / Medium	C	1/2	7/8	650
HDSZ-0350MR#DE-D	ZB26KCE	\$10,250	\$10,240	\$10,760	\$1,080	D / Medium	E	1/2	7/8	650
HDSZ-0400MR#BC-D	ZB30KCE	\$8,580	\$8,580	\$9,030	\$1,080	B / Medium	C	5/8	7/8	650
HDSZ-0400MR#DE-D	ZB30KCE	\$10,620	\$10,620	\$11,140	\$1,080	D / Medium	E	5/8	7/8	650
HDSZ-0500MR#DE-D	ZB38KCE	\$10,620	\$10,620	\$11,140	\$1,080	D / Medium	E	5/8	7/8	650
HDSZ-0500MR#FF-D	ZB38KCE	\$13,650	\$13,640	\$14,290	\$1,080	F / Large	F	5/8	7/8	1,200
HDSZ-0600MR#FF-D	ZB48KCE	NA	\$14,190	\$14,840	\$1,080	F / Large	F	5/8	7/8	1,200
HDSZ-0600MR#JH-D	ZB48KCE	NA	\$19,450	\$20,220	\$1,080	J / X-Large	H	5/8	7/8	1,550
HDSZ-0750MR#FF-D	ZB58K5E	NA	\$16,540	\$16,512	\$2,110	F / Large	F	5/8	1-3/8	1,200
HDSZ-0750MR#JH-D	ZB58K5E	NA	\$21,800	\$22,560	\$2,110	J / X-Large	H	5/8	1-3/8	1,550
HDSZ-1000MR#FF-D	ZB76K5E	NA	\$18,820	\$19,330	\$2,110	F / Large	F	5/8	1-3/8	1,200
HDSZ-1000MR#JH-D	ZB76K5E	NA	\$24,080	\$24,740	\$2,110	J / X-Large	H	5/8	1-3/8	1,550
HDSZ-1300MR#JH-D	ZB95K5E	NA	\$23,960	\$24,590	\$2,110	J / X-Large	H	7/8	1-3/8	1,550
HDSZ-1500MR#JH-A	ZB114K5E	NA	\$24,250	\$24,670	\$2,400	J / X-Large	H	7/8	1-3/8	1,550

UNIT MODEL	COMPRESSOR MODEL	LIST PRICE			4 Year Extended Compressor Warranty	TECHNICAL SPECIFICATION				SHIP WGT (LBS)
		208/1/60 D	208/3/60 K	460/3/60 M		Condenser & Cabinet Size	Rcvr Size	Connections		
								Liquid	Suction	
Scroll - Low Temperature R-449A										
HDSZ-0200LR#AB-D	ZF06K4E	\$7,440	\$7,430	\$7,890	\$1,440	A / Small	B	1/2	7/8	400
HDSZ-0200LR#BC-D	ZF06K4E	\$8,900	\$8,890	\$9,440	\$1,440	B / Medium	C	1/2	7/8	650
HDSZ-0250LR#BC-D	ZF08K4E	\$9,250	\$9,250	\$9,700	\$1,440	B / Medium	C	1/2	7/8	650
HDSZ-0250LR#DE-D	ZF08K4E	\$11,070	\$11,070	\$11,590	\$1,440	D / Medium	E	1/2	7/8	650
HDSZ-0300LR#AB-D	ZF09K4E	\$7,920	\$7,920	\$8,470	\$1,440	A / Small	B	1/2	7/8	650
HDSZ-0300LR#BC-D	ZF09K4E	\$9,330	\$9,330	\$9,880	\$1,440	B / Medium	C	1/2	7/8	650
HDSZ-0350LR#BC-D	ZF11K4E	\$8,860	\$8,860	\$9,420	\$1,440	B / Medium	C	1/2	7/8	650
HDSZ-0350LR#DE-D	ZF11K4E	\$10,510	\$10,510	\$11,120	\$1,440	D / Medium	E	1/2	7/8	650
HDSZ-0400LR#BC-D	ZF13K4E	\$9,170	\$9,170	\$9,720	\$1,440	B / Medium	C	1/2	7/8	650
HDSZ-0400LR#DE-D	ZF13K4E	\$10,820	\$10,810	\$11,430	\$1,440	D / Medium	E	1/2	7/8	650
HDSZ-0500LR#BC-D	ZF15K4E	\$9,570	\$9,570	\$10,120	\$1,570	B / Medium	C	1/2	7/8	650
HDSZ-0500LR#DE-D	ZF15K4E	\$11,220	\$11,210	\$11,830	\$1,570	D / Medium	E	1/2	7/8	650
HDSZ-0600LR#BC-A	ZF18K4E	NA	\$9,580	\$10,130	\$1,570	B / Medium	C	5/8	7/8	650
HDSZ-0600LR#DE-D	ZF18K4E	NA	\$11,220	\$11,840	\$1,570	D / Medium	E	5/8	7/8	650
HDSZ-0750LR#DE-D	ZF25K4E	NA	\$14,830	\$15,350	\$1,570	D / Medium	E	5/8	1-3/8	650
HDSZ-0750LR#FF-D	ZF25K4E	NA	\$17,710	\$18,460	\$1,570	F / Large	F	5/8	1-3/8	1,200
HDSZ-1000LR#DE-D	ZF34K5E	NA	\$18,430	\$18,840	\$2,120	D / Medium	E	5/8	1-3/8	650
HDSZ-1000LR#FF-D	ZF34K5E	NA	\$21,700	\$22,240	\$2,120	F / Large	F	5/8	1-3/8	1,200

* H-SERIES OPTIONS PAGE LISTS OPTIONS. USE H-SERIES SOFTWARE FOR ADDITIONAL CUSTOMIZATION.

** ORDERS MUST INCLUDE THE FULL MODEL NUMBER INCLUDING CONDENSER AND RECEIVER "HDSZ-0200MRKAB"

Standard Options on HDSZ units include sealed liquid drier, pumpdown switch, time clock and crating.



HIGH EFFICIENCY H-SERIES PRODUCT DESCRIPTION

Version: July 2020

HDSZ - HIGH EFFICIENCY H-SERIES COPELAND SCROLL CONDENSING UNITS

UNIT MODEL	COMPRESSOR MODEL	LIST PRICE			4 Year Extended Compressor Warranty	TECHNICAL SPECIFICATION				SHIP WGT (LBS)
		208/1/60 D	208/3/60 K	460/3/60 M		Condenser & Cabinet Size	Rcvr Size	Connections		
								Liquid	Suction	
Scroll - Medium Temperature R-404A										
HDSZ-0200MS#BC-D	ZB15KCE	\$8,650	\$8,650	\$9,100	\$1,080	B / Medium	C	1/2	7/8	650
HDSZ-0200MS#DE-D	ZB15KCE	\$10,700	\$10,690	\$11,210	\$1,080	D / Medium	E	1/2	7/8	650
HDSZ-0250MS#BC-D	ZB19KCE	\$7,650	\$7,640	\$8,090	\$1,080	B / Medium	C	1/2	7/8	650
HDSZ-0250MS#DE-D	ZB19KCE	\$9,690	\$9,690	\$10,200	\$1,080	D / Medium	E	1/2	7/8	650
HDSZ-0300MS#BC-D	ZB21KCE	\$8,130	\$8,120	\$8,570	\$1,080	B / Medium	C	1/2	7/8	650
HDSZ-0300MS#DE-D	ZB21KCE	\$10,170	\$10,170	\$10,680	\$1,080	D / Medium	E	1/2	7/8	650
HDSZ-0350MS#BC-A	ZB26KCE	\$8,200	\$8,200	\$8,650	\$1,080	B / Medium	C	1/2	7/8	650
HDSZ-0350MS#DE-D	ZB26KCE	\$10,250	\$10,240	\$10,760	\$1,080	D / Medium	E	1/2	7/8	650
HDSZ-0400MS#BC-D	ZB30KCE	\$8,580	\$8,580	\$9,030	\$1,080	B / Medium	C	5/8	7/8	650
HDSZ-0400MS#DE-D	ZB30KCE	\$10,620	\$10,620	\$11,140	\$1,080	D / Medium	E	5/8	7/8	650
HDSZ-0500MS#DE-D	ZB38KCE	\$10,620	\$10,620	\$11,140	\$1,080	D / Medium	E	5/8	7/8	650
HDSZ-0500MS#FF-D	ZB38KCE	\$13,650	\$13,640	\$14,290	\$1,080	F / Large	F	5/8	7/8	1,200
HDSZ-0600MS#FF-D	ZB48KCE	NA	\$14,190	\$14,840	\$1,080	F / Large	F	5/8	7/8	1,200
HDSZ-0600MS#JH-D	ZB48KCE	NA	\$19,450	\$20,220	\$1,080	J / X-Large	H	5/8	7/8	1,550
HDSZ-0750MS#FF-D	ZB58K5E	NA	\$16,540	\$16,512	\$2,110	F / Large	F	5/8	1-3/8	1,200
HDSZ-0750MS#JH-D	ZB58K5E	NA	\$21,800	\$22,560	\$2,110	J / X-Large	H	5/8	1-3/8	1,550
HDSZ-1000MS#FF-D	ZB76K5E	NA	\$18,820	\$19,330	\$2,110	F / Large	F	5/8	1-3/8	1,200
HDSZ-1000MS#JH-D	ZB76K5E	NA	\$24,080	\$24,740	\$2,110	J / X-Large	H	5/8	1-3/8	1,550
HDSZ-1300MS#JH-D	ZB95K5E	NA	\$23,960	\$24,590	\$2,110	J / X-Large	H	7/8	1-3/8	1,550
HDSZ-1500MS#JH-D	ZB114K5E	NA	\$24,250	\$24,670	\$2,400	J / X-Large	H	7/8	1-3/8	1,550

UNIT MODEL	COMPRESSOR MODEL	LIST PRICE			4 Year Extended Compressor Warranty	TECHNICAL SPECIFICATION				SHIP WGT (LBS)
		208/1/60 D	208/3/60 K	460/3/60 M		Condenser & Cabinet Size	Rcvr Size	Connections		
								Liquid	Suction	
Scroll - Low Temperature R-404A										
HDSZ-0200LS#AB-A	ZF06K4E	\$7,440	\$7,430	\$7,890	\$1,440	A / Small	B	1/2	7/8	400
HDSZ-0200LS#BC-D	ZF06K4E	\$8,900	\$8,890	\$9,440	\$1,440	B / Medium	C	1/2	7/8	650
HDSZ-0250LS#BC-D	ZF08K4E	\$9,250	\$9,250	\$9,700	\$1,440	B / Medium	C	1/2	7/8	650
HDSZ-0250LS#DE-D	ZF08K4E	\$11,070	\$11,070	\$11,590	\$1,440	D / Medium	E	1/2	7/8	650
HDSZ-0300LS#AB-D	ZF09K4E	\$7,920	\$7,920	\$8,470	\$1,440	A / Small	B	1/2	7/8	650
HDSZ-0300LS#BC-D	ZF09K4E	\$9,330	\$9,330	\$9,880	\$1,440	B / Medium	C	1/2	7/8	650
HDSZ-0350LS#BC-D	ZF11K4E	\$8,860	\$8,860	\$9,420	\$1,440	B / Medium	C	1/2	7/8	650
HDSZ-0350LS#DE-D	ZF11K4E	\$10,510	\$10,510	\$11,120	\$1,440	D / Medium	E	1/2	7/8	650
HDSZ-0400LS#BC-D	ZF13K4E	\$9,170	\$9,170	\$9,720	\$1,440	B / Medium	C	1/2	7/8	650
HDSZ-0400LS#DE-D	ZF13K4E	\$10,820	\$10,810	\$11,430	\$1,440	D / Medium	E	1/2	7/8	650
HDSZ-0500LS#BC-D	ZF15K4E	\$9,570	\$9,570	\$10,120	\$1,570	B / Medium	C	1/2	7/8	650
HDSZ-0500LS#DE-D	ZF15K4E	\$11,220	\$11,210	\$11,830	\$1,570	D / Medium	E	1/2	7/8	650
HDSZ-0600LS#BC-D	ZF18K4E	NA	\$9,580	\$10,130	\$1,570	B / Medium	C	5/8	7/8	650
HDSZ-0600LS#DE-D	ZF18K4E	NA	\$11,220	\$11,840	\$1,570	D / Medium	E	5/8	7/8	650
HDSZ-0750LS#DE-D	ZF25K4E	NA	\$14,830	\$15,350	\$1,570	D / Medium	E	5/8	1-3/8	650
HDSZ-0750LS#FF-D	ZF25K4E	NA	\$17,710	\$18,460	\$1,570	F / Large	F	5/8	1-3/8	1,200
HDSZ-1000LS#DE-D	ZF34K5E	NA	\$18,430	\$18,840	\$2,120	D / Medium	E	5/8	1-3/8	650
HDSZ-1000LS#FF-D	ZF34K5E	NA	\$21,700	\$22,240	\$2,120	F / Large	F	5/8	1-3/8	1,200

* H-SERIES OPTIONS PAGE LISTS OPTIONS. USE H-SERIES SOFTWARE FOR ADDITIONAL CUSTOMIZATION.

** ORDERS MUST INCLUDE THE FULL MODEL NUMBER INCLUDING CONDENSER AND RECEIVER "HDSZ-0200MSKAB"

Standard Options on HDSZ units include sealed liquid drier, pumpdown switch, time clock and crating.



HIGH EFFICIENCY H-SERIES PRODUCT DESCRIPTION

Version: July 2020

HDSZ - HIGH EFFICIENCY H-SERIES COPELAND SCROLL CONDENSING UNITS

UNIT MODEL	COMPRESSOR MODEL	LIST PRICE			4 Year Extended Compressor Warranty	TECHNICAL SPECIFICATION				SHIP WGT (LBS)
		208/1/60 D	208/3/60 K	460/3/60 M		Condenser & Cabinet Size	Rcvr Size	Connections		
								Liquid	Suction	
Scroll - Medium Temperature R-448A										
HDSZ-0200MT#BC-D	ZB15KCE	\$8,650	\$8,650	\$9,100	\$1,080	B / Medium	C	1/2	7/8	650
HDSZ-0200MT#DE-D	ZB15KCE	\$10,700	\$10,690	\$11,210	\$1,080	D / Medium	E	1/2	7/8	650
HDSZ-0250MT#BC-D	ZB19KCE	\$7,650	\$7,640	\$8,090	\$1,080	B / Medium	C	1/2	7/8	650
HDSZ-0250MT#DE-D	ZB19KCE	\$9,690	\$9,690	\$10,200	\$1,080	D / Medium	E	1/2	7/8	650
HDSZ-0300MT#BC-D	ZB21KCE	\$8,130	\$8,120	\$8,570	\$1,080	B / Medium	C	1/2	7/8	650
HDSZ-0300MT#DE-D	ZB21KCE	\$10,170	\$10,170	\$10,680	\$1,080	D / Medium	E	1/2	7/8	650
HDSZ-0350MT#BC-A	ZB26KCE	\$8,200	\$8,200	\$8,650	\$1,080	B / Medium	C	1/2	7/8	650
HDSZ-0350MT#DE-D	ZB26KCE	\$10,250	\$10,240	\$10,760	\$1,080	D / Medium	E	1/2	7/8	650
HDSZ-0400MT#BC-D	ZB30KCE	\$8,580	\$8,580	\$9,030	\$1,080	B / Medium	C	5/8	7/8	650
HDSZ-0400MT#DE-D	ZB30KCE	\$10,620	\$10,620	\$11,140	\$1,080	D / Medium	E	5/8	7/8	650
HDSZ-0500MT#DE-D	ZB38KCE	\$10,620	\$10,620	\$11,140	\$1,080	D / Medium	E	5/8	7/8	650
HDSZ-0500MT#FF-D	ZB38KCE	\$13,650	\$13,640	\$14,290	\$1,080	F / Large	F	5/8	7/8	1,200
HDSZ-0600MT#FF-D	ZB48KCE	NA	\$14,190	\$14,840	\$1,080	F / Large	F	5/8	7/8	1,200
HDSZ-0600MT#JH-D	ZB48KCE	NA	\$19,450	\$20,220	\$1,080	J / X-Large	H	5/8	7/8	1,550
HDSZ-0750MT#FF-D	ZB58K5E	NA	\$16,540	\$16,512	\$2,110	F / Large	F	5/8	1-3/8	1,200
HDSZ-0750MT#JH-D	ZB58K5E	NA	\$21,800	\$22,560	\$2,110	J / X-Large	H	5/8	1-3/8	1,550
HDSZ-1000MT#FF-D	ZB76K5E	NA	\$18,820	\$19,330	\$2,110	F / Large	F	5/8	1-3/8	1,200
HDSZ-1000MT#JH-D	ZB76K5E	NA	\$24,080	\$24,740	\$2,110	J / X-Large	H	5/8	1-3/8	1,550
HDSZ-1300MT#JH-D	ZB95K5E	NA	\$23,960	\$24,590	\$2,110	J / X-Large	H	7/8	1-3/8	1,550
HDSZ-1500MT#JH-A	ZB114K5E	NA	\$24,250	\$24,670	\$2,400	J / X-Large	H	7/8	1-3/8	1,550

UNIT MODEL	COMPRESSOR MODEL	LIST PRICE			4 Year Extended Compressor Warranty	TECHNICAL SPECIFICATION				SHIP WGT (LBS)
		208/1/60 D	208/3/60 K	460/3/60 M		Condenser & Cabinet Size	Rcvr Size	Connections		
								Liquid	Suction	
Scroll - Low Temperature R-448A										
HDSZ-0200LT#AB-D	ZF06K4E	\$7,440	\$7,430	\$7,890	\$1,440	A / Small	B	1/2	7/8	400
HDSZ-0200LT#BC-D	ZF06K4E	\$8,900	\$8,890	\$9,440	\$1,440	B / Medium	C	1/2	7/8	650
HDSZ-0250LT#BC-D	ZF08K4E	\$9,250	\$9,250	\$9,700	\$1,440	B / Medium	C	1/2	7/8	650
HDSZ-0250LT#DE-D	ZF08K4E	\$11,070	\$11,070	\$11,590	\$1,440	D / Medium	E	1/2	7/8	650
HDSZ-0300LT#AB-D	ZF09K4E	\$7,920	\$7,920	\$8,470	\$1,440	A / Small	B	1/2	7/8	650
HDSZ-0300LT#BC-D	ZF09K4E	\$9,330	\$9,330	\$9,880	\$1,440	B / Medium	C	1/2	7/8	650
HDSZ-0350LT#BC-D	ZF11K4E	\$8,860	\$8,860	\$9,420	\$1,440	B / Medium	C	1/2	7/8	650
HDSZ-0350LT#DE-D	ZF11K4E	\$10,510	\$10,510	\$11,120	\$1,440	D / Medium	E	1/2	7/8	650
HDSZ-0400LT#BC-D	ZF13K4E	\$9,170	\$9,170	\$9,720	\$1,440	B / Medium	C	1/2	7/8	650
HDSZ-0400LT#DE-D	ZF13K4E	\$10,820	\$10,810	\$11,430	\$1,440	D / Medium	E	1/2	7/8	650
HDSZ-0500LT#BC-D	ZF15K4E	\$9,570	\$9,570	\$10,120	\$1,570	B / Medium	C	1/2	7/8	650
HDSZ-0500LT#DE-D	ZF15K4E	\$11,220	\$11,210	\$11,830	\$1,570	D / Medium	E	1/2	7/8	650
HDSZ-0600LT#BC-A	ZF18K4E	NA	\$9,580	\$10,130	\$1,570	B / Medium	C	5/8	7/8	650
HDSZ-0600LT#DE-D	ZF18K4E	NA	\$11,220	\$11,840	\$1,570	D / Medium	E	5/8	7/8	650
HDSZ-0750LT#DE-D	ZF25K4E	NA	\$14,830	\$15,350	\$1,570	D / Medium	E	5/8	1-3/8	650
HDSZ-0750LT#FF-D	ZF25K4E	NA	\$17,710	\$18,460	\$1,570	F / Large	F	5/8	1-3/8	1,200
HDSZ-1000LT#DE-D	ZF34K5E	NA	\$18,430	\$18,840	\$2,120	D / Medium	E	5/8	1-3/8	650
HDSZ-1000LT#FF-D	ZF34K5E	NA	\$21,700	\$22,240	\$2,120	F / Large	F	5/8	1-3/8	1,200

* H-SERIES OPTIONS PAGE LISTS OPTIONS. USE H-SERIES SOFTWARE FOR ADDITIONAL CUSTOMIZATION.

** ORDERS MUST INCLUDE THE FULL MODEL NUMBER INCLUDING CONDENSER AND RECEIVER "HDSZ-0200MTKAB"

Standard Options on HDSZ units include sealed liquid drier, pumpdown switch, time clock and crating.



HIGH EFFICIENCY H-SERIES PRODUCT DESCRIPTION

Version: July 2020

HDSS - HIGH EFFICIENCY H-SERIES COPELAND SEMI-HERMETIC CONDENSING UNITS

UNIT MODEL	COMPRESSOR MODEL	LIST PRICE			4 Year Extended Compressor Warranty	TECHNICAL SPECIFICATION				SHIP WGT (LBS)
		208/1/60 D	208/3/60 K	460/3/60 M		Condenser & Cabinet Size	Rcvr Size	Connections		
Semi-Hermetic - Med Temperature R-507A										
HDSS-0072MP#BC-A	KAN#-007E	\$8,670	\$8,610	-	\$1,010	B / Medium	C	1/2	5/8	650
HDSS-0100MP#BC-A	KAR#-010E	\$8,670	\$8,610	\$9,070	\$1,010	B / Medium	C	1/2	7/8	650
HDSS-0200MP#BC-A	KAK#-020E	\$8,840	\$9,220	-	\$1,230	B / Medium	C	1/2	7/8	650
HDSS-0201MP#BC-D	ERC#-021E	-	\$9,220	\$9,680	\$1,390	B / Medium	C	1/2	7/8	650
HDSS-0300MP#DE-D	ERF#-031E	-	\$10,820	\$11,280	\$1,450	D / Medium	E	1/2	1-1/8	650

UNIT MODEL	COMPRESSOR MODEL	LIST PRICE			4 Year Extended Compressor Warranty	TECHNICAL SPECIFICATION				SHIP WGT (LBS)
		208/1/60 D	208/3/60 K	460/3/60 M		Condenser & Cabinet Size	Rcvr Size	Connections		
Semi-Hermetic - Low Temperature R-507A										
HDSS-0050LPKAB-D	KAN#-006E	-	\$6,220	-	\$1,010	A / Small	B	1/2	7/8	400
HDSS-0050LPDAB-D	KAN#-005E	\$6,220	-	-	\$1,010	A / Small	B	1/2	7/8	400
HDSS-0050LP#BC-D	KAN#-006E	-	\$7,600	-	\$1,010	B / Medium	C	1/2	7/8	650
HDSS-0050LPDBC-D	KAN#-005E	\$7,600	-	-	\$1,010	B / Medium	C	1/2	7/8	650
HDSS-0070LP#AB-D	KAM#-007E	\$6,460	\$6,460	-	\$1,010	A / Small	B	1/2	7/8	400
HDSS-0070LP#BC-D	KAM#-007E	\$7,840	\$7,840	-	\$1,010	B / Medium	C	1/2	7/8	650
HDSS-0100LP#AB-D	KAJ#-011E	-	\$6,490	\$6,950	\$1,010	A / Small	B	1/2	7/8	400
HDSS-0100LP#BC-D	KAJ#-011E	-	\$7,870	\$8,330	\$1,010	B / Medium	C	1/2	7/8	650
HDSS-0150LP#BC-D	KAL#-015E	\$8,770	\$8,770	\$9,220	\$1,130	B / Medium	C	1/2	7/8	650
HDSS-0200LP#AB-D	EAV#-021E	\$7,710	\$7,710	\$8,160	\$1,050	A / Small	B	1/2	7/8	400
HDSS-0200LP#BC-A	EAV#-021E	\$9,510	\$9,510	\$9,960	\$1,050	B / Medium	C	1/2	7/8	650
HDSS-0250LP#BC-D	LAH#-032E	\$9,560	\$9,560	\$10,020	\$1,500	B / Medium	C	1/2	1-1/8	650
HDSS-0250LP#DE-D	LAH#-032E	\$11,640	\$11,640	\$12,100	\$1,500	D / Medium	E	1/2	1-1/8	650

* H-SERIES OPTIONS PAGE LISTS OPTIONS. USE H-SERIES SOFTWARE FOR ADDITIONAL CUSTOMIZATION.

** ORDERS MUST INCLUDE THE FULL MODEL NUMBER INCLUDING CONDENSER AND RECEIVER "HDSS-0070LSKAB"

Standard Options on HDSS units include sealed liquid drier, pumptdown switch, time clock and crating.

Prices, product availability, and specifications are subject to change without notice.



HIGH EFFICIENCY H-SERIES PRODUCT DESCRIPTION

Version: July 2020

HDSS - HIGH EFFICIENCY H-SERIES COPELAND SEMI-HERMETIC CONDENSING UNITS

UNIT MODEL	COMPRESSOR MODEL	LIST PRICE			4 Year Extended Compressor Warranty	TECHNICAL SPECIFICATION				SHIP WGT (LBS)
		208/1/60 D	208/3/60 K	460/3/60 M		Condenser & Cabinet Size	Rcvr Size	Connections		
								Liquid	Suction	
Semi-Hermetic - Med Temperature R-449A										
HDSS-0072MR#BC-A	KAN#-007E	\$8,670	\$8,610	-	\$1,010	B / Medium	C	1/2	5/8	650
HDSS-0100MR#BC-A	KAR#-010E	\$8,670	\$8,610	\$9,070	\$1,010	B / Medium	C	1/2	7/8	650
HDSS-0200MR#BC-A	KAK#-020E	\$8,840	\$9,220	-	\$1,230	B / Medium	C	1/2	7/8	650
HDSS-0201MR#BC-D	ERC#-021E	-	\$9,220	\$9,680	\$1,390	B / Medium	C	1/2	7/8	650
HDSS-0300MR#DE-D	ERF#-031E	-	\$10,820	\$11,280	\$1,450	D / Medium	E	1/2	1-1/8	650

UNIT MODEL	COMPRESSOR MODEL	LIST PRICE			4 Year Extended Compressor Warranty	TECHNICAL SPECIFICATION				SHIP WGT (LBS)
		208/1/60 D	208/3/60 K	460/3/60 M		Condenser & Cabinet Size	Rcvr Size	Connections		
								Liquid	Suction	
Semi-Hermetic - Low Temperature R-449A										
HDSS-0050LRKAB-D	KAN#-006E	-	\$6,220	-	\$1,010	A / Small	B	1/2	7/8	400
HDSS-0050LRDAB-D	KAN#-005E	\$6,220	-	-	\$1,010	A / Small	B	1/2	7/8	400
HDSS-0050LR#BC-D	KAN#-006E	-	\$7,600	-	\$1,010	B / Medium	C	1/2	7/8	650
HDSS-0050LRDBC-D	KAN#-005E	\$7,600	-	-	\$1,010	B / Medium	C	1/2	7/8	650
HDSS-0070LR#AB-D	KAM#-007E	\$6,460	\$6,460	-	\$1,010	A / Small	B	1/2	7/8	400
HDSS-0070LR#BC-D	KAM#-007E	\$7,840	\$7,840	-	\$1,010	B / Medium	C	1/2	7/8	650
HDSS-0100LR#AB-D	KAJ#-011E	-	\$6,490	\$6,950	\$1,010	A / Small	B	1/2	7/8	400
HDSS-0100LR#BC-D	KAJ#-011E	-	\$7,870	\$8,330	\$1,010	B / Medium	C	1/2	7/8	650
HDSS-0150LR#BC-D	KAL#-015E	\$8,770	\$8,770	\$9,220	\$1,130	B / Medium	C	1/2	7/8	650
HDSS-0200LR#AB-D	EAV#-021E	\$7,710	\$7,710	\$8,160	\$1,050	A / Small	B	1/2	7/8	400
HDSS-0200LR#BC-A	EAV#-021E	\$9,510	\$9,510	\$9,960	\$1,050	B / Medium	C	1/2	7/8	650
HDSS-0250LR#BC-D	LAH#-032E	\$9,560	\$9,560	\$10,020	\$1,500	B / Medium	C	1/2	1-1/8	650
HDSS-0250LR#DE-D	LAH#-032E	\$11,640	\$11,640	\$12,100	\$1,500	D / Medium	E	1/2	1-1/8	650

* H-SERIES OPTIONS PAGE LISTS OPTIONS. USE H-SERIES SOFTWARE FOR ADDITIONAL CUSTOMIZATION.

** ORDERS MUST INCLUDE THE FULL MODEL NUMBER INCLUDING CONDENSER AND RECEIVER "HDSS-0070LSKAB"

Standard Options on HDSS units include sealed liquid drier, pumpdown switch, time clock and crating.

Prices, product availability, and specifications are subject to change without notice.



HIGH EFFICIENCY H-SERIES PRODUCT DESCRIPTION

Version: July 2020

HDSS - HIGH EFFICIENCY H-SERIES COPELAND SEMI-HERMETIC CONDENSING UNITS

UNIT MODEL	COMPRESSOR MODEL	LIST PRICE			4 Year Extended Compressor Warranty	TECHNICAL SPECIFICATION				SHIP WGT (LBS)
		208/1/60 D	208/3/60 K	460/3/60 M		Condenser & Cabinet Size	Rcvr Size	Connections		
Semi-Hermetic - Med Temperature R-404A										
HDSS-0072MS#BC-A	KAN#-007E	\$8,670	\$8,610	-	\$1,010	B / Medium	C	1/2	5/8	650
HDSS-0100MS#BC-A	KAR#-010E	\$8,670	\$8,610	\$9,070	\$1,010	B / Medium	C	1/2	7/8	650
HDSS-0200MS#BC-A	KAK#-020E	\$8,840	\$9,220	-	\$1,230	B / Medium	C	1/2	7/8	650
HDSS-0201MS#BC-D	ERC#-021E	-	\$9,220	\$9,680	\$1,390	B / Medium	C	1/2	7/8	650
HDSS-0300MS#DE-D	ERF#-031E	-	\$10,820	\$11,280	\$1,450	D / Medium	E	1/2	1-1/8	650

UNIT MODEL	COMPRESSOR MODEL	LIST PRICE			4 Year Extended Compressor Warranty	TECHNICAL SPECIFICATION				SHIP WGT (LBS)
		208/1/60 D	208/3/60 K	460/3/60 M		Condenser & Cabinet Size	Rcvr Size	Connections		
Semi-Hermetic - Low Temperature R-404A										
HDSS-0050LSKAB-D	KAN#-006E	-	\$6,220	-	\$1,010	A / Small	B	1/2	7/8	400
HDSS-0050LSDAB-D	KAN#-005E	\$6,220	-	-	\$1,010	A / Small	B	1/2	7/8	400
HDSS-0050LS#BC-D	KAN#-006E	-	\$7,600	-	\$1,010	B / Medium	C	1/2	7/8	650
HDSS-0050LSDBC-D	KAN#-005E	\$7,600	-	-	\$1,010	B / Medium	C	1/2	7/8	650
HDSS-0070LS#AB-D	KAM#-007E	\$6,460	\$6,460	-	\$1,010	A / Small	B	1/2	7/8	400
HDSS-0070LS#BC-D	KAM#-007E	\$7,840	\$7,840	-	\$1,010	B / Medium	C	1/2	7/8	650
HDSS-0100LS#AB-D	KAJ#-011E	-	\$6,490	\$6,950	\$1,010	A / Small	B	1/2	7/8	400
HDSS-0100LS#BC-D	KAJ#-011E	-	\$7,870	\$8,330	\$1,010	B / Medium	C	1/2	7/8	650
HDSS-0150LS#BC-D	KAL#-015E	\$8,770	\$8,770	\$9,220	\$1,130	B / Medium	C	1/2	7/8	650
HDSS-0200LS#AB-D	EAV#-021E	\$7,710	\$7,710	\$8,160	\$1,050	A / Small	B	1/2	7/8	400
HDSS-0200LS#BC-A	EAV#-021E	\$9,510	\$9,510	\$9,960	\$1,050	B / Medium	C	1/2	7/8	650
HDSS-0250LS#BC-D	LAH#-032E	\$9,560	\$9,560	\$10,020	\$1,500	B / Medium	C	1/2	1-1/8	650
HDSS-0250LS#DE-D	LAH#-032E	\$11,640	\$11,640	\$12,100	\$1,500	D / Medium	E	1/2	1-1/8	650

* H-SERIES OPTIONS PAGE LISTS OPTIONS. USE H-SERIES SOFTWARE FOR ADDITIONAL CUSTOMIZATION.

** ORDERS MUST INCLUDE THE FULL MODEL NUMBER INCLUDING CONDENSER AND RECEIVER "HDSS-0070LSKAB"

Standard Options on HDSS units include sealed liquid drier, pumpdown switch, time clock and crating.

Prices, product availability, and specifications are subject to change without notice.



HIGH EFFICIENCY H-SERIES PRODUCT DESCRIPTION

Version: July 2020

HDSS - HIGH EFFICIENCY H-SERIES COPELAND SEMI-HERMETIC CONDENSING UNITS

UNIT MODEL	COMPRESSOR MODEL	LIST PRICE			4 Year Extended Compressor Warranty	TECHNICAL SPECIFICATION				SHIP WGT (LBS)
		208/1/60 D	208/3/60 K	460/3/60 M		Condenser & Cabinet Size	Rcvr Size	Connections		
								Liquid	Suction	
Semi-Hermetic - Med Temperature R-448A										
HDSS-0072MT#BC-A	KAN#-007E	\$8,670	\$8,610	-	\$1,010	B / Medium	C	1/2	5/8	650
HDSS-0100MT#BC-A	KAR#-010E	\$8,670	\$8,610	\$9,070	\$1,010	B / Medium	C	1/2	7/8	650
HDSS-0200MT#BC-A	KAK#-020E	\$8,840	\$9,220	-	\$1,230	B / Medium	C	1/2	7/8	650
HDSS-0201MT#BC-D	ERC#-021E	-	\$9,220	\$9,680	\$1,390	B / Medium	C	1/2	7/8	650
HDSS-0300MT#DE-D	ERF#-031E	-	\$10,820	\$11,280	\$1,450	D / Medium	E	1/2	1-1/8	650

UNIT MODEL	COMPRESSOR MODEL	LIST PRICE			4 Year Extended Compressor Warranty	TECHNICAL SPECIFICATION				SHIP WGT (LBS)
		208/1/60 D	208/3/60 K	460/3/60 M		Condenser & Cabinet Size	Rcvr Size	Connections		
								Liquid	Suction	
Semi-Hermetic - Low Temperature R-448A										
HDSS-0050LTKAB-D	KAN#-006E	-	\$6,220	-	\$1,010	A / Small	B	1/2	7/8	400
HDSS-0050LTDAB-D	KAN#-005E	\$6,220	-	-	\$1,010	A / Small	B	1/2	7/8	400
HDSS-0050LT#BC-D	KAN#-006E	-	\$7,600	-	\$1,010	B / Medium	C	1/2	7/8	650
HDSS-0050LTD#BC-D	KAN#-005E	\$7,600	-	-	\$1,010	B / Medium	C	1/2	7/8	650
HDSS-0070LT#AB-D	KAM#-007E	\$6,460	\$6,460	-	\$1,010	A / Small	B	1/2	7/8	400
HDSS-0070LT#BC-D	KAM#-007E	\$7,840	\$7,840	-	\$1,010	B / Medium	C	1/2	7/8	650
HDSS-0100LT#AB-D	KAJ#-011E	-	\$6,490	\$6,950	\$1,010	A / Small	B	1/2	7/8	400
HDSS-0100LT#BC-D	KAJ#-011E	-	\$7,870	\$8,330	\$1,010	B / Medium	C	1/2	7/8	650
HDSS-0150LT#BC-D	KAL#-015E	\$8,770	\$8,770	\$9,220	\$1,130	B / Medium	C	1/2	7/8	650
HDSS-0200LT#AB-D	EAV#-021E	\$7,710	\$7,710	\$8,160	\$1,050	A / Small	B	1/2	7/8	400
HDSS-0200LT#BC-A	EAV#-021E	\$9,510	\$9,510	\$9,960	\$1,050	B / Medium	C	1/2	7/8	650
HDSS-0250LT#BC-D	LAH#-032E	\$9,560	\$9,560	\$10,020	\$1,500	B / Medium	C	1/2	1-1/8	650
HDSS-0250LT#DE-D	LAH#-032E	\$11,640	\$11,640	\$12,100	\$1,500	D / Medium	E	1/2	1-1/8	650

* H-SERIES OPTIONS PAGE LISTS OPTIONS. USE H-SERIES SOFTWARE FOR ADDITIONAL CUSTOMIZATION.

** ORDERS MUST INCLUDE THE FULL MODEL NUMBER INCLUDING CONDENSER AND RECEIVER "HDSS-0070LSKAB"

Standard Options on HDSS units include sealed liquid drier, pumpdown switch, time clock and crating.

Prices, product availability, and specifications are subject to change without notice.



HIGH EFFICIENCY H-SERIES PRODUCT DESCRIPTION

Version: July 2020

HDSD - HIGH EFFICIENCY H-SERIES COPELAND DISCUS CONDENSING UNITS

UNIT MODEL	COMPRESSOR MODEL	LIST PRICE		4 Year Extended Compressor Warranty	TECHNICAL SPECIFICATION				SHIP WGT (LBS)
		208/3/60 K	460/3/60 M		Condenser & Cabinet Size	Rcvr Size	Connections		
							Liquid	Suction	
Discus - Medium Temperature R-407F									
HDSD-0500MF#BC-D	2DC3R53KE	\$13,170	\$13,620	\$1,810	B / Medium	C	1/2	1-3/8	800
HDSD-0500MF#DE-D	2DC3R53KE	\$15,210	\$15,730	\$1,810	D / Medium	E	1/2	1-3/8	800
HDSD-0501MF#DE-D	2DD3R63KE	\$15,310	\$15,830	\$1,810	D / Medium	E	5/8	1-3/8	800
HDSD-0501MF#FF-D	2DD3R63KE	\$18,580	\$19,230	\$1,810	F / Large	F	5/8	1-3/8	1,250
HDSD-0750MF#FF-D	2DL3R78KE	\$19,470	\$20,100	\$2,250	F / Large	F	5/8	1-3/8	1,250
HDSD-0750MF#JH-D	2DL3R78KE	\$24,730	\$25,490	\$2,250	J / X-Large	H	5/8	1-3/8	1,575
HDSD-0751MF#FF-D	2DA3R89KE	\$18,810	\$19,440	\$2,250	F / Large	F	5/8	1-3/8	1,575
HDSD-0751MF#JH-D	2DA3R89KE	\$24,070	\$24,830	\$2,250	J / X-Large	H	5/8	1-3/8	1,575
HDSD-0752MF#FF-D	3DA3R10ME	\$19,460	\$20,000	\$2,250	F / Large	F	5/8	1-3/8	1,250
HDSD-0752MF#JH-D	3DA3R10ME	\$24,720	\$25,380	\$2,250	J / X-Large	H	5/8	1-3/8	1,575
HDSD-1000MF#FF-D	3DB3R12ME	\$20,470	\$21,000	\$2,870	F / Large	F	7/8	1-3/8	1,250
HDSD-1000MF#JH-D	3DB3R12ME	\$25,720	\$26,390	\$2,870	J / X-Large	H	7/8	1-3/8	1,575
HDSD-1200MF#JH-D	3DF3R15ME	\$24,800	\$25,460	\$3,290	J / X-Large	H	7/8	1-3/8	1,575
HDSD-1500MF#JH-D	3DS3R17ME	\$24,800	\$25,390	\$4,350	J / X-Large	H	7/8	1-5/8	1,575

UNIT MODEL	COMPRESSOR MODEL	LIST PRICE		4 Year Extended Compressor Warranty	TECHNICAL SPECIFICATION				SHIP WGT (LBS)
		208/3/60 K	460/3/60 M		Condenser & Cabinet Size	Rcvr Size	Connections		
							Liquid	Suction	
Discus - Low Temperature - INCLUDES DEMAND COOLING REQUIRED FOR R-407F									
HDSD-0300LF#BC-D	2DF3F16KE	\$14,580	\$15,030	\$2,480	B / Medium	C	1/2	1-3/8	800
HDSD-0300LF#DE-D	2DF3F16KE	\$16,620	\$17,140	\$2,480	D / Medium	E	1/2	1-3/8	800
HDSD-0400LF#BC-D	2DL3F20KE	\$14,980	\$15,430	\$2,530	B / Medium	C	5/8	1-3/8	800
HDSD-0400LF#DE-D	2DL3F20KE	\$17,030	\$17,540	\$2,530	D / Medium	E	5/8	1-3/8	800
HDSD-0600LF#BC-D	2DB3F25KE	\$15,490	\$15,930	\$2,620	B / Medium	C	5/8	1-3/8	800
HDSD-0600LF#DE-D	2DB3F25KE	\$17,600	\$18,100	\$2,620	D / Medium	E	5/8	1-3/8	800
HDSD-0601LF#BC-D	3DA3F28KE	\$15,650	\$16,100	\$3,580	B / Medium	C	5/8	1-3/8	800
HDSD-0601LF#DE-D	3DA3F28KE	\$17,690	\$18,210	\$3,580	D / Medium	E	5/8	1-3/8	800
HDSD-0750LF#DE-D	3DB3F33KE	\$17,760	\$18,260	\$3,580	D / Medium	E	5/8	1-3/8	800
HDSD-0750LF#FF-D	3DB3F33KE	\$21,040	\$21,670	\$3,580	F / Large	F	5/8	1-3/8	1250
HDSD-0900LF#FF-D	3DF3F40KE	\$21,750	\$22,340	\$3,740	F / Large	F	5/8	1-3/8	1250
HDSD-0900LF#JH-D	3DF3F40KE	\$27,000	\$27,720	\$3,740	J / X-Large	H	5/8	1-3/8	1575
HDSD-1000LF#FF-D	3DS3F46KE	\$23,060	\$23,590	\$4,130	F / Large	F	5/8	1-3/8	1,250
HDSD-1000LF#JH-D	3DS3F46KE	\$28,310	\$28,970	\$4,130	J / X-Large	H	5/8	1-3/8	1,575
HDSD-1500LF#JH-D	4DHN63KE	\$29,800	\$30,430	\$5,250	J / X-Large	H	7/8	1-5/8	1,575
HDSD-2200LF#FF-A	4DJNF76KE	\$24,240	\$24,540	\$5,250	F / Large	F	7/8	2-1/8	1,250
HDSD-2200LF#JH-A	4DJNF76KE	\$30,170	\$30,590	\$5,250	J / X-Large	H	7/8	2-1/8	1,575

* H-SERIES OPTIONS PAGE LISTS OPTIONS. USE H-SERIES SOFTWARE FOR ADDITIONAL CUSTOMIZATION.

** ORDERS MUST INCLUDE THE FULL MODEL NUMBER "HDSD-0500MFKBD-D"

HDSD options include sealed liquid drier, pumpdown switch, time clock, solid mounted compressor and crating.

Prices, product availability, and specifications are subject to change without notice.



HIGH EFFICIENCY H-SERIES PRODUCT DESCRIPTION

Version: July 2020

HDSD - HIGH EFFICIENCY H-SERIES COPELAND DISCUS CONDENSING UNITS

UNIT MODEL	COMPRESSOR MODEL	LIST PRICE		4 Year Extended Compressor Warranty	TECHNICAL SPECIFICATION				SHIP WGT (LBS)
		208/3/60 K	460/3/60 M		Condenser & Cabinet Size	Rcvr Size	Connections		
							Liquid	Suction	
Discus - Medium Temperature R-507A									
HDSD-0500MP#BC-D	2DC3R53KE	\$13,170	\$13,620	\$1,810	B / Medium	C	1/2	1-3/8	800
HDSD-0500MP#DE-D	2DC3R53KE	\$15,210	\$15,730	\$1,810	D / Medium	E	1/2	1-3/8	800
HDSD-0501MP#DE-D	2DD3R63KE	\$15,310	\$15,830	\$1,810	D / Medium	E	5/8	1-3/8	800
HDSD-0501MP#FF-D	2DD3R63KE	\$18,580	\$19,230	\$1,810	F / Large	F	5/8	1-3/8	1,250
HDSD-0750MP#FF-D	2DL3R78KE	\$19,470	\$20,100	\$2,250	F / Large	F	5/8	1-3/8	1,250
HDSD-0750MP#JH-D	2DL3R78KE	\$24,730	\$25,490	\$2,250	J / X-Large	H	5/8	1-3/8	1,575
HDSD-0751MP#FF-D	2DA3R89KE	\$18,810	\$19,440	\$2,250	F / Large	F	5/8	1-3/8	1,575
HDSD-0751MP#JH-D	2DA3R89KE	\$24,070	\$24,830	\$2,250	J / X-Large	H	5/8	1-3/8	1,575
HDSD-0752MP#FF-D	3DA3R10ME	\$19,460	\$20,000	\$2,250	F / Large	F	5/8	1-3/8	1,250
HDSD-0752MP#JH-D	3DA3R10ME	\$24,720	\$25,380	\$2,250	J / X-Large	H	5/8	1-3/8	1,575
HDSD-1000MP#FF-D	3DB3R12ME	\$20,470	\$21,000	\$2,870	F / Large	F	7/8	1-3/8	1,250
HDSD-1000MP#JH-D	3DB3R12ME	\$25,720	\$26,390	\$2,870	J / X-Large	H	7/8	1-3/8	1,575
HDSD-1200MP#JH-D	3DF3R15ME	\$24,800	\$25,460	\$3,290	J / X-Large	H	7/8	1-3/8	1,575
HDSD-1500MP#JH-D	3DS3R17ME	\$24,800	\$25,390	\$4,350	J / X-Large	H	7/8	1-5/8	1,575

UNIT MODEL	COMPRESSOR MODEL	LIST PRICE		4 Year Extended Compressor Warranty	TECHNICAL SPECIFICATION				SHIP WGT (LBS)
		208/3/60 K	460/3/60 M		Condenser & Cabinet Size	Rcvr Size	Connections		
							Liquid	Suction	
Discus - Low Temperature R-507A									
HDSD-0300LP#BC-D	2DF3F16KE	\$13,060	\$13,510	\$2,480	B / Medium	C	1/2	1-3/8	800
HDSD-0300LP#DE-D	2DF3F16KE	\$15,100	\$15,620	\$2,480	D / Medium	E	1/2	1-3/8	800
HDSD-0400LP#BC-D	2DL3F20KE	\$13,460	\$13,910	\$2,530	B / Medium	C	5/8	1-3/8	800
HDSD-0400LP#DE-D	2DL3F20KE	\$15,510	\$16,020	\$2,530	D / Medium	E	5/8	1-3/8	800
HDSD-0600LP#BC-D	2DB3F25KE	\$13,970	\$14,410	\$2,620	B / Medium	C	5/8	1-3/8	800
HDSD-0600LP#DE-D	2DB3F25KE	\$16,080	\$16,580	\$2,620	D / Medium	E	5/8	1-3/8	800
HDSD-0601LP#BC-D	3DA3F28KE	\$14,130	\$14,580	\$3,580	B / Medium	C	5/8	1-3/8	800
HDSD-0601LP#DE-D	3DA3F28KE	\$16,170	\$16,690	\$3,580	D / Medium	E	5/8	1-3/8	800
HDSD-0750LP#DE-D	3DB3F33KE	\$16,240	\$16,740	\$3,580	D / Medium	E	5/8	1-3/8	800
HDSD-0750LP#FF-D	3DB3F33KE	\$19,520	\$20,150	\$3,580	F / Large	F	5/8	1-3/8	1250
HDSD-0900LP#FF-D	3DF3F40KE	\$20,230	\$20,820	\$3,740	F / Large	F	5/8	1-3/8	1250
HDSD-0900LP#JH-D	3DF3F40KE	\$25,480	\$26,200	\$3,740	J / X-Large	H	5/8	1-3/8	1575
HDSD-1000LP#FF-D	3DS3F46KE	\$21,540	\$22,070	\$4,130	F / Large	F	5/8	1-3/8	1,250
HDSD-1000LP#JH-D	3DS3F46KE	\$26,790	\$27,450	\$4,130	J / X-Large	H	5/8	1-3/8	1,575
HDSD-1500LP#JH-D	4DHN63KE	\$28,280	\$28,910	\$5,250	J / X-Large	H	7/8	1-5/8	1,575
HDSD-2200LP#FF-A	4DJNF76KE	\$22,720	\$23,020	\$5,250	F / Large	F	7/8	2-1/8	1,250
HDSD-2200LP#JH-D	4DJNF76KE	\$28,650	\$29,080	\$5,250	J / X-Large	H	7/8	2-1/8	1,575

* H-SERIES OPTIONS PAGE LISTS OPTIONS. USE H-SERIES SOFTWARE FOR ADDITIONAL CUSTOMIZATION.

** ORDERS MUST INCLUDE THE FULL MODEL NUMBER "HDSD-0500MPKBD-D"

HDSD options include sealed liquid drier, pumpdown switch, time clock, solid mounted compressor and crating.

Prices, product availability, and specifications are subject to change without notice.



HIGH EFFICIENCY H-SERIES PRODUCT DESCRIPTION

Version: July 2020

HDSD - HIGH EFFICIENCY H-SERIES COPELAND DISCUS CONDENSING UNITS

UNIT MODEL	COMPRESSOR MODEL	LIST PRICE		4 Year Extended Compressor Warranty	TECHNICAL SPECIFICATION				SHIP WGT (LBS)
		208/3/60 K	460/3/60 M		Condenser & Cabinet Size	Rcvr Size	Connections		
							Liquid	Suction	
Discus - Medium Temperature R-407A									
HDSD-0500MQ#BC-D	2DC3R53KE	\$13,170	\$13,620	\$1,810	B / Medium	C	1/2	1-3/8	800
HDSD-0500MQ#DE-D	2DC3R53KE	\$15,210	\$15,730	\$1,810	D / Medium	E	1/2	1-3/8	800
HDSD-0501MQ#DE-D	2DD3R63KE	\$15,310	\$15,830	\$1,810	D / Medium	E	5/8	1-3/8	800
HDSD-0501MQ#FF-D	2DD3R63KE	\$18,580	\$19,230	\$1,810	F / Large	F	5/8	1-3/8	1,250
HDSD-0750MQ#FF-D	2DL3R78KE	\$19,470	\$20,100	\$2,250	F / Large	F	5/8	1-3/8	1,250
HDSD-0750MQ#JH-D	2DL3R78KE	\$24,730	\$25,490	\$2,250	J / X-Large	H	5/8	1-3/8	1,575
HDSD-0751MQ#FF-D	2DA3R89KE	\$18,810	\$19,440	\$2,250	F / Large	F	5/8	1-3/8	1,575
HDSD-0751MQ#JH-D	2DA3R89KE	\$24,070	\$24,830	\$2,250	J / X-Large	H	5/8	1-3/8	1,575
HDSD-0752MQ#FF-D	3DA3R10ME	\$19,460	\$20,000	\$2,250	F / Large	F	5/8	1-3/8	1,250
HDSD-0752MQ#JH-D	3DA3R10ME	\$24,720	\$25,380	\$2,250	J / X-Large	H	5/8	1-3/8	1,575
HDSD-1000MQ#FF-D	3DB3R12ME	\$20,470	\$21,000	\$2,870	F / Large	F	7/8	1-3/8	1,250
HDSD-1000MQ#JH-D	3DB3R12ME	\$25,720	\$26,390	\$2,870	J / X-Large	H	7/8	1-3/8	1,575
HDSD-1200MQ#JH-D	3DF3R15ME	\$24,800	\$25,460	\$3,290	J / X-Large	H	7/8	1-3/8	1,575
HDSD-1500MQ#JH-D	3DS3R17ME	\$24,800	\$25,390	\$4,350	J / X-Large	H	7/8	1-5/8	1,575

UNIT MODEL	COMPRESSOR MODEL	LIST PRICE		4 Year Extended Compressor Warranty	TECHNICAL SPECIFICATION				SHIP WGT (LBS)
		208/3/60 K	460/3/60 M		Condenser & Cabinet Size	Rcvr Size	Connections		
							Liquid	Suction	
Discus - Low Temperature - INCLUDES DEMAND COOLING REQUIRED FOR R-407A									
HDSD-0300LQ#BC-D	2DF3F16KE	\$14,580	\$15,030	\$2,480	B / Medium	C	1/2	1-3/8	800
HDSD-0300LQ#DE-D	2DF3F16KE	\$16,620	\$17,140	\$2,480	D / Medium	E	1/2	1-3/8	800
HDSD-0400LQ#BC-D	2DL3F20KE	\$14,980	\$15,430	\$2,530	B / Medium	C	5/8	1-3/8	800
HDSD-0400LQ#DE-D	2DL3F20KE	\$17,030	\$17,540	\$2,530	D / Medium	E	5/8	1-3/8	800
HDSD-0600LQ#BC-D	2DB3F25KE	\$15,490	\$15,930	\$2,620	B / Medium	C	5/8	1-3/8	800
HDSD-0600LQ#DE-D	2DB3F25KE	\$17,600	\$18,100	\$2,620	D / Medium	E	5/8	1-3/8	800
HDSD-0601LQ#BC-D	3DA3F28KE	\$15,650	\$16,100	\$3,580	B / Medium	C	5/8	1-3/8	800
HDSD-0601LQ#DE-D	3DA3F28KE	\$17,690	\$18,210	\$3,580	D / Medium	E	5/8	1-3/8	800
HDSD-0750LQ#DE-D	3DB3F33KE	\$17,760	\$18,260	\$3,580	D / Medium	E	5/8	1-3/8	800
HDSD-0750LQ#FF-D	3DB3F33KE	\$21,040	\$21,670	\$3,580	F / Large	F	5/8	1-3/8	1250
HDSD-0900LQ#FF-D	3DF3F40KE	\$21,750	\$22,340	\$3,740	F / Large	F	5/8	1-3/8	1250
HDSD-0900LQ#JH-D	3DF3F40KE	\$27,000	\$27,720	\$3,740	J / X-Large	H	5/8	1-3/8	1575
HDSD-1000LQ#FF-D	3DS3F46KE	\$23,060	\$23,590	\$4,130	F / Large	F	5/8	1-3/8	1,250
HDSD-1000LQ#JH-D	3DS3F46KE	\$28,310	\$28,970	\$4,130	J / X-Large	H	5/8	1-3/8	1,575
HDSD-1500LQ#JH-D	4DHN63KE	\$29,800	\$30,430	\$5,250	J / X-Large	H	7/8	1-5/8	1,575
HDSD-2200LQ#FF-A	4DJNF76KE	\$24,240	\$24,540	\$5,250	F / Large	F	7/8	2-1/8	1,250
HDSD-2200LQ#JH-A	4DJNF76KE	\$30,170	\$30,590	\$5,250	J / X-Large	H	7/8	2-1/8	1,575

* H-SERIES OPTIONS PAGE LISTS OPTIONS. USE H-SERIES SOFTWARE FOR ADDITIONAL CUSTOMIZATION.

** ORDERS MUST INCLUDE THE FULL MODEL NUMBER "HDSD-0500MQKBD-D"

HDSD options include sealed liquid drier, pumpdown switch, time clock, solid mounted compressor and crating.

Prices, product availability, and specifications are subject to change without notice.



HIGH EFFICIENCY H-SERIES PRODUCT DESCRIPTION

Version: July 2020

HDSD - HIGH EFFICIENCY H-SERIES COPELAND DISCUS CONDENSING UNITS

UNIT MODEL	COMPRESSOR MODEL	LIST PRICE		4 Year Extended Compressor Warranty	TECHNICAL SPECIFICATION				SHIP WGT (LBS)
		208/3/60 K	460/3/60 M		Condenser & Cabinet Size	Rcvr Size	Connections		
							Liquid	Suction	
Discus - Medium Temperature R-449A									
HDSD-0500MR#BC-D	2DC3R53KE	\$13,170	\$13,620	\$1,810	B / Medium	C	1/2	1-3/8	800
HDSD-0500MR#DE-D	2DC3R53KE	\$15,210	\$15,730	\$1,810	D / Medium	E	1/2	1-3/8	800
HDSD-0501MR#DE-D	2DD3R63KE	\$15,310	\$15,830	\$1,810	D / Medium	E	5/8	1-3/8	800
HDSD-0501MR#FF-D	2DD3R63KE	\$18,580	\$19,230	\$1,810	F / Large	F	5/8	1-3/8	1,250
HDSD-0750MR#FF-D	2DL3R78KE	\$19,470	\$20,100	\$2,250	F / Large	F	5/8	1-3/8	1,250
HDSD-0750MR#JH-D	2DL3R78KE	\$24,730	\$25,490	\$2,250	J / X-Large	H	5/8	1-3/8	1,575
HDSD-0751MR#FF-D	2DA3R89KE	\$18,810	\$19,440	\$2,250	F / Large	F	5/8	1-3/8	1,575
HDSD-0751MR#JH-D	2DA3R89KE	\$24,070	\$24,830	\$2,250	J / X-Large	H	5/8	1-3/8	1,575
HDSD-0752MR#FF-D	3DA3R10ME	\$19,460	\$20,000	\$2,250	F / Large	F	5/8	1-3/8	1,250
HDSD-0752MR#JH-D	3DA3R10ME	\$24,720	\$25,380	\$2,250	J / X-Large	H	5/8	1-3/8	1,575
HDSD-1000MR#FF-D	3DB3R12ME	\$20,470	\$21,000	\$2,870	F / Large	F	7/8	1-3/8	1,250
HDSD-1000MR#JH-D	3DB3R12ME	\$25,720	\$26,390	\$2,870	J / X-Large	H	7/8	1-3/8	1,575
HDSD-1200MR#JH-D	3DF3R15ME	\$24,800	\$25,460	\$3,290	J / X-Large	H	7/8	1-3/8	1,575
HDSD-1500MR#JH-D	3DS3R17ME	\$24,800	\$25,390	\$4,350	J / X-Large	H	7/8	1-5/8	1,575

UNIT MODEL	COMPRESSOR MODEL	LIST PRICE		4 Year Extended Compressor Warranty	TECHNICAL SPECIFICATION				SHIP WGT (LBS)
		208/3/60 K	460/3/60 M		Condenser & Cabinet Size	Rcvr Size	Connections		
							Liquid	Suction	
Discus - Low Temperature - INCLUDES DEMAND COOLING REQUIRED FOR R-449A									
HDSD-0300LR#BC-D	2DF3F16KE	\$14,580	\$15,030	\$2,480	B / Medium	C	1/2	1-3/8	800
HDSD-0300LR#DE-D	2DF3F16KE	\$16,620	\$17,140	\$2,480	D / Medium	E	1/2	1-3/8	800
HDSD-0400LR#BC-D	2DL3F20KE	\$14,980	\$15,430	\$2,530	B / Medium	C	5/8	1-3/8	800
HDSD-0400LR#DE-D	2DL3F20KE	\$17,030	\$17,540	\$2,530	D / Medium	E	5/8	1-3/8	800
HDSD-0600LR#BC-D	2DB3F25KE	\$15,490	\$15,930	\$2,620	B / Medium	C	5/8	1-3/8	800
HDSD-0600LR#DE-D	2DB3F25KE	\$17,600	\$18,100	\$2,620	D / Medium	E	5/8	1-3/8	800
HDSD-0601LR#BC-D	3DA3F28KE	\$15,650	\$16,100	\$3,580	B / Medium	C	5/8	1-3/8	800
HDSD-0601LR#DE-D	3DA3F28KE	\$17,690	\$18,210	\$3,580	D / Medium	E	5/8	1-3/8	800
HDSD-0750LR#DE-D	3DB3F33KE	\$17,760	\$18,260	\$3,580	D / Medium	E	5/8	1-3/8	800
HDSD-0750LR#FF-D	3DB3F33KE	\$21,040	\$21,670	\$3,580	F / Large	F	5/8	1-3/8	1250
HDSD-0900LR#FF-D	3DF3F40KE	\$21,750	\$22,340	\$3,740	F / Large	F	5/8	1-3/8	1250
HDSD-0900LR#JH-D	3DF3F40KE	\$27,000	\$27,720	\$3,740	J / X-Large	H	5/8	1-3/8	1575
HDSD-1000LR#FF-D	3DS3F46KE	\$23,060	\$23,590	\$4,130	F / Large	F	5/8	1-3/8	1,250
HDSD-1000LR#JH-D	3DS3F46KE	\$28,310	\$28,970	\$4,130	J / X-Large	H	5/8	1-3/8	1,575
HDSD-1500LR#JH-A	4DHNF63KE	\$29,800	\$30,430	\$5,250	J / X-Large	H	7/8	1-5/8	1,575
HDSD-2200LR#FF-A	4DJNF76KE	\$24,240	\$24,540	\$5,250	F / Large	F	7/8	2-1/8	1,250
HDSD-2200LR#JH-A	4DJNF76KE	\$30,170	\$30,590	\$5,250	J / X-Large	H	7/8	2-1/8	1,575

* H-SERIES OPTIONS PAGE LISTS OPTIONS. USE H-SERIES SOFTWARE FOR ADDITIONAL CUSTOMIZATION.

** ORDERS MUST INCLUDE THE FULL MODEL NUMBER "HDSD-0500MR#BD-D"

HDSD options include sealed liquid drier, pumpdown switch, time clock, solid mounted compressor and crating.

Prices, product availability, and specifications are subject to change without notice.



HIGH EFFICIENCY H-SERIES PRODUCT DESCRIPTION

Version: July 2020

HDSD - HIGH EFFICIENCY H-SERIES COPELAND DISCUS CONDENSING UNITS

UNIT MODEL	COMPRESSOR MODEL	LIST PRICE		4 Year Extended Compressor Warranty	TECHNICAL SPECIFICATION				SHIP WGT (LBS)
		208/3/60 K	460/3/60 M		Condenser & Cabinet Size	Rcvr Size	Connections		
							Liquid	Suction	
Discus - Medium Temperature R-404A									
HDSD-0500MS#BC-D	2DC3R53KE	\$13,170	\$13,620	\$1,810	B / Medium	C	1/2	1-3/8	800
HDSD-0500MS#DE-D	2DC3R53KE	\$15,210	\$15,730	\$1,810	D / Medium	E	1/2	1-3/8	800
HDSD-0501MS#DE-D	2DD3R63KE	\$15,310	\$15,830	\$1,810	D / Medium	E	5/8	1-3/8	800
HDSD-0501MS#FF-D	2DD3R63KE	\$18,580	\$19,230	\$1,810	F / Large	F	5/8	1-3/8	1,250
HDSD-0750MS#FF-D	2DL3R78KE	\$19,470	\$20,100	\$2,250	F / Large	F	5/8	1-3/8	1,250
HDSD-0750MS#JH-D	2DL3R78KE	\$24,730	\$25,490	\$2,250	J / X-Large	H	5/8	1-3/8	1,575
HDSD-0751MS#FF-D	2DA3R89KE	\$18,810	\$19,440	\$2,250	F / Large	F	5/8	1-3/8	1,575
HDSD-0751MS#JH-D	2DA3R89KE	\$24,070	\$24,830	\$2,250	J / X-Large	H	5/8	1-3/8	1,575
HDSD-0752MS#FF-D	3DA3R10ME	\$19,460	\$20,000	\$2,250	F / Large	F	5/8	1-3/8	1,250
HDSD-0752MS#JH-D	3DA3R10ME	\$24,720	\$25,380	\$2,250	J / X-Large	H	5/8	1-3/8	1,575
HDSD-1000MS#FF-D	3DB3R12ME	\$20,470	\$21,000	\$2,870	F / Large	F	7/8	1-3/8	1,250
HDSD-1000MS#JH-D	3DB3R12ME	\$25,720	\$26,390	\$2,870	J / X-Large	H	7/8	1-3/8	1,575
HDSD-1200MS#JH-D	3DF3R15ME	\$24,800	\$25,460	\$3,290	J / X-Large	H	7/8	1-3/8	1,575
HDSD-1500MS#JH-D	3DS3R17ME	\$24,800	\$25,390	\$4,350	J / X-Large	H	7/8	1-5/8	1,575

UNIT MODEL	COMPRESSOR MODEL	LIST PRICE		4 Year Extended Compressor Warranty	TECHNICAL SPECIFICATION				SHIP WGT (LBS)
		208/3/60 K	460/3/60 M		Condenser & Cabinet Size	Rcvr Size	Connections		
							Liquid	Suction	
Discus - Low Temperature R-404A									
HDSD-0300LS#BC-D	2DF3F16KE	\$13,060	\$13,510	\$2,480	B / Medium	C	1/2	1-3/8	800
HDSD-0300LS#DE-D	2DF3F16KE	\$15,100	\$15,620	\$2,480	D / Medium	E	1/2	1-3/8	800
HDSD-0400LS#BC-D	2DL3F20KE	\$13,460	\$13,910	\$2,530	B / Medium	C	5/8	1-3/8	800
HDSD-0400LS#DE-D	2DL3F20KE	\$15,510	\$16,020	\$2,530	D / Medium	E	5/8	1-3/8	800
HDSD-0600LS#BC-D	2DB3F25KE	\$13,970	\$14,410	\$2,620	B / Medium	C	5/8	1-3/8	800
HDSD-0600LS#DE-D	2DB3F25KE	\$16,080	\$16,580	\$2,620	D / Medium	E	5/8	1-3/8	800
HDSD-0601LS#BC-D	3DA3F28KE	\$14,130	\$14,580	\$3,580	B / Medium	C	5/8	1-3/8	800
HDSD-0601LS#DE-D	3DA3F28KE	\$16,170	\$16,690	\$3,580	D / Medium	E	5/8	1-3/8	800
HDSD-0750LS#DE-D	3DB3F33KE	\$16,240	\$16,740	\$3,580	D / Medium	E	5/8	1-3/8	800
HDSD-0750LS#FF-D	3DB3F33KE	\$19,520	\$20,150	\$3,580	F / Large	F	5/8	1-3/8	1250
HDSD-0900LS#FF-D	3DF3F40KE	\$20,230	\$20,820	\$3,740	F / Large	F	5/8	1-3/8	1250
HDSD-0900LS#JH-D	3DF3F40KE	\$25,480	\$26,200	\$3,740	J / X-Large	H	5/8	1-3/8	1575
HDSD-1000LS#FF-D	3DS3F46KE	\$21,540	\$22,070	\$4,130	F / Large	F	5/8	1-3/8	1,250
HDSD-1000LS#JH-D	3DS3F46KE	\$26,790	\$27,450	\$4,130	J / X-Large	H	5/8	1-3/8	1,575
HDSD-1500LS#JH-D	4DHN63KE	\$28,280	\$28,910	\$5,250	J / X-Large	H	7/8	1-5/8	1,575
HDSD-2200LS#FF-A	4DJNF76KE	\$22,720	\$23,020	\$5,250	F / Large	F	7/8	2-1/8	1,250
HDSD-2200LS#JH-D	4DJNF76KE	\$28,650	\$29,080	\$5,250	J / X-Large	H	7/8	2-1/8	1,575

* H-SERIES OPTIONS PAGE LISTS OPTIONS. USE H-SERIES SOFTWARE FOR ADDITIONAL CUSTOMIZATION.

** ORDERS MUST INCLUDE THE FULL MODEL NUMBER "HDSD-0500MSKBD-D"

HDSD options include sealed liquid drier, pumpdown switch, time clock, solid mounted compressor and crating.

Prices, product availability, and specifications are subject to change without notice.



HIGH EFFICIENCY H-SERIES PRODUCT DESCRIPTION

Version: July 2020

HDSD - HIGH EFFICIENCY H-SERIES COPELAND DISCUS CONDENSING UNITS

UNIT MODEL	COMPRESSOR MODEL	LIST PRICE		4 Year Extended Compressor Warranty	TECHNICAL SPECIFICATION				SHIP WGT (LBS)
		208/3/60 K	460/3/60 M		Condenser & Cabinet Size	Rcvr Size	Connections		
Discus - Medium Temperature R-448A									
HDSD-0500MT#BC-D	2DC3R53KE	\$13,170	\$13,620	\$1,810	B / Medium	C	1/2	1-3/8	800
HDSD-0500MT#DE-D	2DC3R53KE	\$15,210	\$15,730	\$1,810	D / Medium	E	1/2	1-3/8	800
HDSD-0501MT#DE-D	2DD3R63KE	\$15,310	\$15,830	\$1,810	D / Medium	E	5/8	1-3/8	800
HDSD-0501MT#FF-D	2DD3R63KE	\$18,580	\$19,230	\$1,810	F / Large	F	5/8	1-3/8	1,250
HDSD-0750MT#FF-D	2DL3R78KE	\$19,470	\$20,100	\$2,250	F / Large	F	5/8	1-3/8	1,250
HDSD-0750MT#JH-D	2DL3R78KE	\$24,730	\$25,490	\$2,250	J / X-Large	H	5/8	1-3/8	1,575
HDSD-0751MT#FF-D	2DA3R89KE	\$18,810	\$19,440	\$2,250	F / Large	F	5/8	1-3/8	1,575
HDSD-0751MT#JH-D	2DA3R89KE	\$24,070	\$24,830	\$2,250	J / X-Large	H	5/8	1-3/8	1,575
HDSD-0752MT#FF-D	3DA3R10ME	\$19,460	\$20,000	\$2,250	F / Large	F	5/8	1-3/8	1,250
HDSD-0752MT#JH-D	3DA3R10ME	\$24,720	\$25,380	\$2,250	J / X-Large	H	5/8	1-3/8	1,575
HDSD-1000MT#FF-D	3DB3R12ME	\$20,470	\$21,000	\$2,870	F / Large	F	7/8	1-3/8	1,250
HDSD-1000MT#JH-D	3DB3R12ME	\$25,720	\$26,390	\$2,870	J / X-Large	H	7/8	1-3/8	1,575
HDSD-1200MT#JH-D	3DF3R15ME	\$24,800	\$25,460	\$3,290	J / X-Large	H	7/8	1-3/8	1,575
HDSD-1500MT#JH-D	3DS3R17ME	\$24,800	\$25,390	\$4,350	J / X-Large	H	7/8	1-5/8	1,575

UNIT MODEL	COMPRESSOR MODEL	LIST PRICE		4 Year Extended Compressor Warranty	TECHNICAL SPECIFICATION				SHIP WGT (LBS)
		208/3/60 K	460/3/60 M		Condenser & Cabinet Size	Rcvr Size	Connections		
Discus - Low Temperature - INCLUDES DEMAND COOLING REQUIRED FOR R-448A									
HDSD-0300LT#BC-D	2DF3F16KE	\$14,580	\$15,030	\$2,480	B / Medium	C	1/2	1-3/8	800
HDSD-0300LT#DE-D	2DF3F16KE	\$16,620	\$17,140	\$2,480	D / Medium	E	1/2	1-3/8	800
HDSD-0400LT#BC-D	2DL3F20KE	\$14,980	\$15,430	\$2,530	B / Medium	C	5/8	1-3/8	800
HDSD-0400LT#DE-D	2DL3F20KE	\$17,030	\$17,540	\$2,530	D / Medium	E	5/8	1-3/8	800
HDSD-0600LT#BC-D	2DB3F25KE	\$15,490	\$15,930	\$2,620	B / Medium	C	5/8	1-3/8	800
HDSD-0600LT#DE-D	2DB3F25KE	\$17,600	\$18,100	\$2,620	D / Medium	E	5/8	1-3/8	800
HDSD-0601LT#BC-D	3DA3F28KE	\$15,650	\$16,100	\$3,580	B / Medium	C	5/8	1-3/8	800
HDSD-0601LT#DE-D	3DA3F28KE	\$17,690	\$18,210	\$3,580	D / Medium	E	5/8	1-3/8	800
HDSD-0750LT#DE-D	3DB3F33KE	\$17,760	\$18,260	\$3,580	D / Medium	E	5/8	1-3/8	800
HDSD-0750LT#FF-D	3DB3F33KE	\$21,040	\$21,670	\$3,580	F / Large	F	5/8	1-3/8	1250
HDSD-0900LT#FF-D	3DF3F40KE	\$21,750	\$22,340	\$3,740	F / Large	F	5/8	1-3/8	1250
HDSD-0900LT#JH-D	3DF3F40KE	\$27,000	\$27,720	\$3,740	J / X-Large	H	5/8	1-3/8	1575
HDSD-1000LT#FF-D	3DS3F46KE	\$23,060	\$23,590	\$4,130	F / Large	F	5/8	1-3/8	1,250
HDSD-1000LT#JH-D	3DS3F46KE	\$28,310	\$28,970	\$4,130	J / X-Large	H	5/8	1-3/8	1,575
HDSD-1500LT#JH-A	4DHNF63KE	\$29,800	\$30,430	\$5,250	J / X-Large	H	7/8	1-5/8	1,575
HDSD-2200LT#FF-A	4DJNF76KE	\$24,240	\$24,540	\$5,250	F / Large	F	7/8	2-1/8	1,250
HDSD-2200LT#JH-A	4DJNF76KE	\$30,170	\$30,590	\$5,250	J / X-Large	H	7/8	2-1/8	1,575

* H-SERIES OPTIONS PAGE LISTS OPTIONS. USE H-SERIES SOFTWARE FOR ADDITIONAL CUSTOMIZATION.

** ORDERS MUST INCLUDE THE FULL MODEL NUMBER "HDSD-0500MTKBD-D"

HDSD options include sealed liquid drier, pumpdown switch, time clock, solid mounted compressor and crating.

Prices, product availability, and specifications are subject to change without notice.



HIGH EFFICIENCY H-SERIES PRODUCT DESCRIPTION

Version: July 2020

HDSB - HIGH EFFICIENCY H-SERIES BITZER ECOLINE CONDENSING UNITS

UNIT MODEL	COMPRESSOR MODEL	LIST PRICE		4 Year Extended Compressor Warranty	TECHNICAL SPECIFICATION				SHIP WGT (LBS)
		208/3/60 K	460/3/60 M		Condenser & Cabinet Size	Rcvr Size	Connections		
Bitzer Ecoline - Medium Temperature R-407F									
HDSB-0050MF#BC-D	2KES-05	\$9,850	\$10,300	\$1,020	B / Medium	C	1/2	5/8	550
HDSB-0070MF#BC-D	2JES-07	\$9,940	\$10,390	\$1,020	B / Medium	C	1/2	5/8	550
HDSB-0070MF#DE-D	2JES-07	\$11,980	\$12,500	\$1,020	D / Medium	E	1/2	5/8	550
HDSB-0100MF#BC-D	2HES-1	\$10,120	\$10,570	\$1,020	B / Medium	C	1/2	5/8	550
HDSB-0100MF#DE-D	2HES-1	\$12,170	\$12,680	\$1,020	D / Medium	E	1/2	5/8	550
HDSB-0150MF#BC-D	2FES-2	\$10,160	\$10,610	\$1,020	B / Medium	C	5/8	5/8	550
HDSB-0150MF#DE-D	2FES-2	\$12,200	\$12,720	\$1,020	D / Medium	E	5/8	5/8	550
HDSB-0200MF#BC-D	2EES-2	\$11,040	\$11,490	\$1,410	B / Medium	C	5/8	7/8	550
HDSB-0200MF#DE-D	2EES-2	\$13,080	\$13,600	\$1,410	D / Medium	E	5/8	7/8	550
HDSB-0220MF#DE-D	2DES-2	\$13,330	\$13,850	\$1,410	D / Medium	E	5/8	7/8	550
HDSB-0220MF#FF-D	2DES-2	\$16,610	\$17,250	\$1,410	F / Large	F	5/8	7/8	1,250
HDSB-0300MF#DE-D	2CES-3	\$13,480	\$14,000	\$1,410	D / Medium	E	5/8	7/8	550
HDSB-0300MF#FF-D	2CES-3	\$16,760	\$17,400	\$1,410	F / Large	F	5/8	7/8	1,250
HDSB-0400MF#FF-D	4FES-3	\$17,590	\$18,240	\$1,970	F / Large	F	5/8	7/8	1,250
HDSB-0400MF#JH-D	4FES-3	\$22,850	\$23,620	\$1,970	J / X-Large	H	5/8	7/8	1,575
HDSB-0500MF#FF-D	4EES-4	\$17,810	\$18,450	\$1,970	F / Large	F	5/8	1-1/8	1,250
HDSB-0500MF#JH-D	4EES-4	\$23,070	\$23,830	\$1,970	J / X-Large	H	5/8	1-1/8	1,575
HDSB-0600MF#FF-D	4DES-5	\$18,320	\$18,960	\$1,970	F / Large	F	5/8	1-1/8	1,250
HDSB-0600MF#JH-D	4DES-5	\$23,570	\$24,340	\$1,970	J / X-Large	H	5/8	1-1/8	1,575
HDSB-0650MF#FF-D	4CES-6	\$19,690	\$20,320	\$1,970	F / Large	F	5/8	1-1/8	1,250
HDSB-0650MF#JH-D	4CES-6	\$24,930	\$25,700	\$1,970	J / X-Large	H	5/8	1-1/8	1,575
HDSB-0700MF#FF-D	4VES-7	\$19,950	\$20,590	\$2,680	F / Large	F	7/8	1-1/8	1,250
HDSB-0700MF#JH-D	4VES-7	\$25,200	\$25,970	\$2,680	J / X-Large	H	7/8	1-1/8	1,575
HDSB-0900MF#JH-D	4TES-9	\$25,540	\$26,260	\$2,680	J / X-Large	H	7/8	1-3/8	1,575
HDSB-1000MF#JH-D	4PES-12	\$25,730	\$26,390	\$2,680	J / X-Large	H	7/8	1-3/8	1,575
HDSB-1200MF#JH-A	4NES-14	\$26,450	\$27,070	\$2,680	J / X-Large	H	7/8	1-3/8	1,575

UNIT MODEL	COMPRESSOR MODEL	LIST PRICE		Opt 4-Year Extended Compressor Warranty	TECHNICAL SPECIFICATION				SHIP WGT (LBS)
		208/3/60 K	460/3/60 M		Cabinet Size	Rcvr Size	Connections		
Bitzer Ecoline - Low Temperature R-407F									
HDSB-0050LF#AB-D	2KES-05	\$8,940	\$9,300	\$1,020	A / Small	B	1/2	5/8	400
HDSB-0050LF#BC-D	2KES-05	\$10,270	\$10,690	\$1,020	B / Medium	C	1/2	5/8	550
HDSB-0070LF#AB-D	2JES-07	\$9,080	\$9,390	\$1,020	A / Small	B	1/2	5/8	400
HDSB-0070LF#BC-D	2JES-07	\$10,360	\$10,810	\$1,020	B / Medium	C	1/2	5/8	550
HDSB-0100LF#AB-D	2HES-1	\$9,120	\$9,440	\$1,020	A / Small	B	1/2	5/8	400
HDSB-0100LF#BC-D	2HES-1	\$10,540	\$10,990	\$1,020	B / Medium	C	1/2	5/8	550
HDSB-0150LF#AB-D	2FES-2	\$9,020	\$9,610	\$1,020	A / Small	B	1/2	5/8	400
HDSB-0150LF#BC-D	2FES-2	\$10,580	\$10,890	\$1,020	B / Medium	C	1/2	5/8	550
HDSB-0200LF#AB-D	2EES-2	\$9,960	\$10,270	\$1,410	A / Small	B	1/2	7/8	400
HDSB-0200LF#BC-D	2EES-2	\$11,380	\$11,830	\$1,410	B / Medium	C	1/2	7/8	550
HDSB-0220LF#AB-D	2DES-2	\$10,210	\$10,660	\$1,410	A / Small	B	1/2	7/8	400
HDSB-0220LF#BC-D	2DES-2	\$11,630	\$12,080	\$1,410	B / Medium	C	1/2	7/8	550
HDSB-0300LF#AB-D	2CES-3	\$10,220	\$10,810	\$1,410	A / Small	B	5/8	7/8	400
HDSB-0300LF#BC-D	2CES-3	\$11,780	\$12,230	\$1,410	B / Medium	C	5/8	7/8	550
HDSB-0400LF#BC-D	4FES-3	\$13,140	\$13,590	\$1,970	B / Medium	C	5/8	7/8	550
HDSB-0400LF#DE-D	4FES-3	\$15,190	\$15,700	\$1,970	D / Medium	E	5/8	7/8	550
HDSB-0500LF#BC-D	4EES-4	\$13,340	\$13,790	\$1,970	B / Medium	C	5/8	1-1/8	550
HDSB-0500LF#DE-D	4EES-4	\$15,630	\$15,890	\$1,970	D / Medium	E	5/8	1-1/8	550
HDSB-0600LF#BC-D	4DES-5	\$14,090	\$14,270	\$1,970	B / Medium	C	5/8	1-1/8	550
HDSB-0600LF#DE-D	4DES-5	\$15,870	\$16,380	\$1,970	D / Medium	E	5/8	1-1/8	550
HDSB-0650LF#BC-D	4CES-6	\$16,070	\$16,500	\$1,970	B / Medium	C	5/8	1-1/8	550
HDSB-0650LF#DE-D	4CES-6	\$17,250	\$17,750	\$1,970	D / Medium	E	5/8	1-1/8	550
HDSB-0700LF#BC-D	4VES-7	\$15,400	\$15,710	\$2,680	B / Medium	C	5/8	1-1/8	550
HDSB-0700LF#DE-D	4VES-7	\$17,450	\$17,960	\$2,680	D / Medium	E	5/8	1-1/8	550
HDSB-0900LF#DE-D	4TES-9	\$17,710	\$18,170	\$2,680	D / Medium	E	5/8	1-3/8	550
HDSB-1000LF#DE-D	4PES-12	\$17,980	\$18,380	\$2,680	D / Medium	E	5/8	1-3/8	550
HDSB-1200LF#FF-D	4NES-14	\$22,020	\$22,510	\$2,680	F / Large	F	5/8	1-3/8	1,250
HDSB-1200LF#JH-D	4NES-14	\$27,280	\$28,180	\$2,680	J / X-Large	H	5/8	1-3/8	1,575
HDSB-1400LF#FF-D	4JE-15	\$23,680	\$23,970	\$3,880	F / Large	F	7/8	1-5/8	1,250
HDSB-1400LF#JH-D	4JE-15	\$28,450	\$28,870	\$3,880	J / X-Large	H	7/8	1-5/8	1,575
HDSB-1600LF#FF-D	4HE-18	\$23,630	\$23,930	\$3,880	F / Large	F	7/8	1-5/8	1,250
HDSB-1600LF#JH-D	4HE-18	\$28,920	\$29,340	\$3,880	J / X-Large	H	7/8	1-5/8	1,575

* H-SERIES OPTIONS PAGE LISTS OPTIONS. USE H-SERIES SOFTWARE FOR ADDITIONAL CUSTOMIZATION.

** ORDERS MUST INCLUDE THE FULL MODEL NUMBER INCLUDING CONDENSER AND RECEIVER "HDSB-0200MQKAB"

Options on HDSB units include sealed liquid drier, pumpdown switch, time clock, solid mounted compressor and crating.

(1) Maximum +32° F suction operation for B motor 2 compressors shown. Use E model motor 1 compressor where operation may exceed +20° F for more efficient medium temperature operation. Add \$670 list to B motor pricing for E motors, confirm DOE from tech bulletin and update model number.

HIGH EFFICIENCY H-SERIES PRODUCT DESCRIPTION

Version: July 2020

HDSB - HIGH EFFICIENCY H-SERIES BITZER ECOLINE CONDENSING UNITS

UNIT MODEL	COMPRESSOR MODEL	LIST PRICE		4 Year Extended Compressor Warranty	TECHNICAL SPECIFICATION				SHIP WGT (LBS)
		208/3/60 K	460/3/60 M		Condenser & Cabinet Size	Rcvr Size	Connections		
Bitzer Ecoline - Medium Temperature R-507A									
HDSB-0050MP#BC-A	2KES-05	\$9,850	\$10,300	\$1,020	B / Medium	C	1/2	5/8	550
HDSB-0070MP#BC-A	2JES-07	\$9,940	\$10,390	\$1,020	B / Medium	C	1/2	5/8	550
HDSB-0070MP#DE-A	2JES-07	\$11,980	\$12,500	\$1,020	D / Medium	E	1/2	5/8	550
HDSB-0100MP#BC-A	2HES-1	\$10,120	\$10,570	\$1,020	B / Medium	C	1/2	5/8	550
HDSB-0100MP#DE-A	2HES-1	\$12,170	\$12,680	\$1,020	D / Medium	E	1/2	5/8	550
HDSB-0150MP#BC-D	2FES-2	\$10,160	\$10,610	\$1,020	B / Medium	C	5/8	5/8	550
HDSB-0150MP#DE-D	2FES-2	\$12,200	\$12,720	\$1,020	D / Medium	E	5/8	5/8	550
HDSB-0200MP#BC-D	2EES-2	\$11,040	\$11,490	\$1,410	B / Medium	C	5/8	7/8	550
HDSB-0200MP#DE-D	2EES-2	\$13,080	\$13,600	\$1,410	D / Medium	E	5/8	7/8	550
HDSB-0220MP#DE-D	2DES-2	\$13,330	\$13,850	\$1,410	D / Medium	E	5/8	7/8	550
HDSB-0220MP#FF-D	2DES-2	\$16,610	\$17,250	\$1,410	F / Large	F	5/8	7/8	1,250
HDSB-0300MP#DE-D	2CES-3	\$13,480	\$14,000	\$1,410	D / Medium	E	5/8	7/8	550
HDSB-0300MP#FF-D	2CES-3	\$16,760	\$17,400	\$1,410	F / Large	F	5/8	7/8	1,250
HDSB-0400MP#FF-D	4FES-3	\$17,590	\$18,240	\$1,970	F / Large	F	5/8	7/8	1,250
HDSB-0400MP#JH-D	4FES-3	\$22,850	\$23,620	\$1,970	J / X-Large	H	5/8	7/8	1,575
HDSB-0500MP#FF-D	4EES-4	\$17,810	\$18,450	\$1,970	F / Large	F	5/8	1-1/8	1,250
HDSB-0500MP#JH-D	4EES-4	\$23,070	\$23,830	\$1,970	J / X-Large	H	5/8	1-1/8	1,575
HDSB-0600MP#FF-D	4DES-5	\$18,320	\$18,960	\$1,970	F / Large	F	5/8	1-1/8	1,250
HDSB-0600MP#JH-D	4DES-5	\$23,570	\$24,340	\$1,970	J / X-Large	H	5/8	1-1/8	1,575
HDSB-0650MP#FF-D	4CES-6	\$19,690	\$20,320	\$1,970	F / Large	F	5/8	1-1/8	1,250
HDSB-0650MP#JH-D	4CES-6	\$24,930	\$25,700	\$1,970	J / X-Large	H	5/8	1-1/8	1,575
HDSB-0700MP#FF-D	4VES-7	\$19,950	\$20,590	\$2,680	F / Large	F	7/8	1-1/8	1,250
HDSB-0700MP#JH-D	4VES-7	\$25,200	\$25,970	\$2,680	J / X-Large	H	7/8	1-1/8	1,575
HDSB-0900MP#JH-D	4TES-9	\$25,540	\$26,260	\$2,680	J / X-Large	H	7/8	1-3/8	1,575
HDSB-1000MP#JH-D	4PES-12	\$25,730	\$26,390	\$2,680	J / X-Large	H	7/8	1-3/8	1,575
HDSB-1200MP#JH-A	4NES-14	\$26,450	\$27,070	\$2,680	J / X-Large	H	7/8	1-3/8	1,575

UNIT MODEL	COMPRESSOR MODEL	LIST PRICE		Opt 4-Year Extended Compressor Warranty	TECHNICAL SPECIFICATION				SHIP WGT (LBS)
		208/3/60 K	460/3/60 M		Cabinet Size	Rcvr Size	Connections		
Bitzer Ecoline - Low Temperature R-507A									
HDSB-0050LP#AB-D	2KES-05	\$8,380	\$8,750	\$1,020	A / Small	B	1/2	5/8	400
HDSB-0050LP#BC-D	2KES-05	\$9,710	\$10,130	\$1,020	B / Medium	C	1/2	5/8	550
HDSB-0070LP#AB-D	2JES-07	\$8,520	\$8,830	\$1,020	A / Small	B	1/2	5/8	400
HDSB-0070LP#BC-D	2JES-07	\$9,800	\$10,250	\$1,020	B / Medium	C	1/2	5/8	550
HDSB-0100LP#AB-D	2HES-1	\$8,570	\$8,880	\$1,020	A / Small	B	1/2	5/8	400
HDSB-0100LP#BC-D	2HES-1	\$9,980	\$10,430	\$1,020	B / Medium	C	1/2	5/8	550
HDSB-0150LP#AB-D	2FES-2	\$8,460	\$9,050	\$1,020	A / Small	B	1/2	5/8	400
HDSB-0150LP#BC-D	2FES-2	\$10,020	\$10,330	\$1,020	B / Medium	C	1/2	5/8	550
HDSB-0200LP#AB-D	2EES-2	\$9,400	\$9,710	\$1,410	A / Small	B	1/2	7/8	400
HDSB-0200LP#BC-D	2EES-2	\$10,820	\$11,270	\$1,410	B / Medium	C	1/2	7/8	550
HDSB-0220LP#AB-D	2DES-2	\$9,650	\$10,100	\$1,410	A / Small	B	1/2	7/8	400
HDSB-0220LP#BC-D	2DES-2	\$11,070	\$11,520	\$1,410	B / Medium	C	1/2	7/8	550
HDSB-0300LP#AB-D	2CES-3	\$9,660	\$10,250	\$1,410	A / Small	B	5/8	7/8	400
HDSB-0300LP#BC-D	2CES-3	\$11,220	\$11,670	\$1,410	B / Medium	C	5/8	7/8	550
HDSB-0400LP#BC-D	4FES-3	\$12,590	\$13,040	\$1,970	B / Medium	C	5/8	7/8	550
HDSB-0400LP#DE-D	4FES-3	\$14,630	\$15,150	\$1,970	D / Medium	E	5/8	7/8	550
HDSB-0500LP#BC-D	4EES-4	\$12,780	\$13,230	\$1,970	B / Medium	C	5/8	1-1/8	550
HDSB-0500LP#DE-D	4EES-4	\$15,070	\$15,340	\$1,970	D / Medium	E	5/8	1-1/8	550
HDSB-0600LP#BC-D	4DES-5	\$13,530	\$13,710	\$1,970	B / Medium	C	5/8	1-1/8	550
HDSB-0600LP#DE-D	4DES-5	\$15,320	\$15,820	\$1,970	D / Medium	E	5/8	1-1/8	550
HDSB-0650LP#BC-D	4CES-6	\$15,510	\$15,950	\$1,970	B / Medium	C	5/8	1-1/8	550
HDSB-0650LP#DE-D	4CES-6	\$16,690	\$17,190	\$1,970	D / Medium	E	5/8	1-1/8	550
HDSB-0700LP#BC-D	4VES-7	\$14,850	\$15,150	\$2,680	B / Medium	C	5/8	1-1/8	550
HDSB-0700LP#DE-D	4VES-7	\$16,890	\$17,400	\$2,680	D / Medium	E	5/8	1-1/8	550
HDSB-0900LP#DE-D	4TES-9	\$17,150	\$17,610	\$2,680	D / Medium	E	5/8	1-3/8	550
HDSB-1000LP#DE-D	4PES-12	\$17,420	\$17,820	\$2,680	D / Medium	E	5/8	1-3/8	550
HDSB-1200LP#FF-D	4NES-14	\$21,460	\$21,950	\$2,680	F / Large	F	5/8	1-3/8	1,250
HDSB-1200LP#JH-D	4NES-14	\$26,720	\$27,620	\$2,680	J / X-Large	H	5/8	1-3/8	1,575
HDSB-1400LP#FF-D	4JE-15	\$23,120	\$23,410	\$3,880	F / Large	F	7/8	1-5/8	1,250
HDSB-1400LP#JH-D	4JE-15	\$27,890	\$28,310	\$3,880	J / X-Large	H	7/8	1-5/8	1,575
HDSB-1600LP#FF-D	4HE-18	\$23,070	\$23,370	\$3,880	F / Large	F	7/8	1-5/8	1,250
HDSB-1600LP#JH-D	4HE-18	\$28,360	\$28,780	\$3,880	J / X-Large	H	7/8	1-5/8	1,575

* H-SERIES OPTIONS PAGE LISTS OPTIONS. USE H-SERIES SOFTWARE FOR ADDITIONAL CUSTOMIZATION.

** ORDERS MUST INCLUDE THE FULL MODEL NUMBER INCLUDING CONDENSER AND RECEIVER "HDSB-0200MPKAB"

Options on HDSB units include sealed liquid drier, pumpdown switch, time clock, solid mounted compressor and crating.

(1) Maximum +32° F suction operation for B motor 2 compressors shown. Use E model motor 1 compressor where operation may exceed +20° F for more efficient medium temperature operation. Add \$670 list to B motor pricing for E motors, confirm DOE from tech bulletin and update model number.

HIGH EFFICIENCY H-SERIES PRODUCT DESCRIPTION

Version: July 2020

HDSB - HIGH EFFICIENCY H-SERIES BITZER ECOLINE CONDENSING UNITS

UNIT MODEL	COMPRESSOR MODEL	LIST PRICE		4 Year Extended Compressor Warranty	TECHNICAL SPECIFICATION				SHIP WGT (LBS)
		208/3/60 K	460/3/60 M		Condenser & Cabinet Size	Rcvr Size	Connections		
Bitzer Ecoline - Medium Temperature R-407A									
HDSB-0050MQ#BC-A	2KES-05	\$9,850	\$10,300	\$1,020	B / Medium	C	1/2	5/8	550
HDSB-0070MQ#BC-D	2JES-07	\$9,940	\$10,390	\$1,020	B / Medium	C	1/2	5/8	550
HDSB-0070MQ#DE-A	2JES-07	\$11,980	\$12,500	\$1,020	D / Medium	E	1/2	5/8	550
HDSB-0100MQ#BC-D	2HES-1	\$10,120	\$10,570	\$1,020	B / Medium	C	1/2	5/8	550
HDSB-0100MQ#DE-D	2HES-1	\$12,170	\$12,680	\$1,020	D / Medium	E	1/2	5/8	550
HDSB-0150MQ#BC-D	2FES-2	\$10,160	\$10,610	\$1,020	B / Medium	C	5/8	5/8	550
HDSB-0150MQ#DE-D	2FES-2	\$12,200	\$12,720	\$1,020	D / Medium	E	5/8	5/8	550
HDSB-0200MQ#BC-D	2EES-2	\$11,040	\$11,490	\$1,410	B / Medium	C	5/8	7/8	550
HDSB-0200MQ#DE-D	2EES-2	\$13,080	\$13,600	\$1,410	D / Medium	E	5/8	7/8	550
HDSB-0220MQ#DE-D	2DES-2	\$13,330	\$13,850	\$1,410	D / Medium	E	5/8	7/8	550
HDSB-0220MQ#FF-D	2DES-2	\$16,610	\$17,250	\$1,410	F / Large	F	5/8	7/8	1,250
HDSB-0300MQ#DE-D	2CES-3	\$13,480	\$14,000	\$1,410	D / Medium	E	5/8	7/8	550
HDSB-0300MQ#FF-D	2CES-3	\$16,760	\$17,400	\$1,410	F / Large	F	5/8	7/8	1,250
HDSB-0400MQ#FF-D	4FES-3	\$17,590	\$18,240	\$1,970	F / Large	F	5/8	7/8	1,250
HDSB-0400MQ#JH-D	4FES-3	\$22,850	\$23,620	\$1,970	J / X-Large	H	5/8	7/8	1,575
HDSB-0500MQ#FF-D	4EES-4	\$17,810	\$18,450	\$1,970	F / Large	F	5/8	1-1/8	1,250
HDSB-0500MQ#JH-D	4EES-4	\$23,070	\$23,830	\$1,970	J / X-Large	H	5/8	1-1/8	1,575
HDSB-0600MQ#FF-D	4DES-5	\$18,320	\$18,960	\$1,970	F / Large	F	5/8	1-1/8	1,250
HDSB-0600MQ#JH-D	4DES-5	\$23,570	\$24,340	\$1,970	J / X-Large	H	5/8	1-1/8	1,575
HDSB-0650MQ#FF-D	4CES-6	\$19,690	\$20,320	\$1,970	F / Large	F	5/8	1-1/8	1,250
HDSB-0650MQ#JH-D	4CES-6	\$24,930	\$25,700	\$1,970	J / X-Large	H	5/8	1-1/8	1,575
HDSB-0700MQ#FF-D	4VES-7	\$19,950	\$20,590	\$2,680	F / Large	F	7/8	1-1/8	1,250
HDSB-0700MQ#JH-D	4VES-7	\$25,200	\$25,970	\$2,680	J / X-Large	H	7/8	1-1/8	1,575
HDSB-0900MQ#JH-D	4TES-9	\$25,540	\$26,260	\$2,680	J / X-Large	H	7/8	1-3/8	1,575
HDSB-1000MQ#JH-D	4PES-12	\$25,730	\$26,390	\$2,680	J / X-Large	H	7/8	1-3/8	1,575
HDSB-1200MQ#JH-D	4NES-14	\$26,450	\$27,070	\$2,680	J / X-Large	H	7/8	1-3/8	1,575

UNIT MODEL	COMPRESSOR MODEL	LIST PRICE		Opt 4-Year Extended Compressor Warranty	TECHNICAL SPECIFICATION				SHIP WGT (LBS)
		208/3/60 K	460/3/60 M		Cabinet Size	Rcvr Size	Connections		
Bitzer Ecoline - Low Temperature R-407A									
HDSB-0050LQ#AB-D	2KES-05	\$8,940	\$9,300	\$1,020	A / Small	B	1/2	5/8	400
HDSB-0050LQ#BC-D	2KES-05	\$10,270	\$10,690	\$1,020	B / Medium	C	1/2	5/8	550
HDSB-0070LQ#AB-D	2JES-07	\$9,080	\$9,390	\$1,020	A / Small	B	1/2	5/8	400
HDSB-0070LQ#BC-D	2JES-07	\$10,360	\$10,810	\$1,020	B / Medium	C	1/2	5/8	550
HDSB-0100LQ#AB-D	2HES-1	\$9,120	\$9,440	\$1,020	A / Small	B	1/2	5/8	400
HDSB-0100LQ#BC-D	2HES-1	\$10,540	\$10,990	\$1,020	B / Medium	C	1/2	5/8	550
HDSB-0150LQ#AB-D	2FES-2	\$9,020	\$9,610	\$1,020	A / Small	B	1/2	5/8	400
HDSB-0150LQ#BC-D	2FES-2	\$10,580	\$10,890	\$1,020	B / Medium	C	1/2	5/8	550
HDSB-0200LQ#AB-D	2EES-2	\$9,960	\$10,270	\$1,410	A / Small	B	1/2	7/8	400
HDSB-0200LQ#BC-D	2EES-2	\$11,380	\$11,830	\$1,410	B / Medium	C	1/2	7/8	550
HDSB-0220LQ#AB-D	2DES-2	\$10,210	\$10,660	\$1,410	A / Small	B	1/2	7/8	400
HDSB-0220LQ#BC-D	2DES-2	\$11,630	\$12,080	\$1,410	B / Medium	C	1/2	7/8	550
HDSB-0300LQ#AB-D	2CES-3	\$10,220	\$10,810	\$1,410	A / Small	B	5/8	7/8	400
HDSB-0300LQ#BC-D	2CES-3	\$11,780	\$12,230	\$1,410	B / Medium	C	5/8	7/8	550
HDSB-0400LQ#BC-D	4FES-3	\$13,140	\$13,590	\$1,970	B / Medium	C	5/8	7/8	550
HDSB-0400LQ#DE-D	4FES-3	\$15,190	\$15,700	\$1,970	D / Medium	E	5/8	7/8	550
HDSB-0500LQ#BC-D	4EES-4	\$13,340	\$13,790	\$1,970	B / Medium	C	5/8	1-1/8	550
HDSB-0500LQ#DE-D	4EES-4	\$15,630	\$15,890	\$1,970	D / Medium	E	5/8	1-1/8	550
HDSB-0600LQ#BC-D	4DES-5	\$14,090	\$14,270	\$1,970	B / Medium	C	5/8	1-1/8	550
HDSB-0600LQ#DE-D	4DES-5	\$15,870	\$16,380	\$1,970	D / Medium	E	5/8	1-1/8	550
HDSB-0650LQ#BC-D	4CES-6	\$16,070	\$16,500	\$1,970	B / Medium	C	5/8	1-1/8	550
HDSB-0650LQ#DE-D	4CES-6	\$17,250	\$17,750	\$1,970	D / Medium	E	5/8	1-1/8	550
HDSB-0700LQ#BC-D	4VES-7	\$15,400	\$15,710	\$2,680	B / Medium	C	5/8	1-1/8	550
HDSB-0700LQ#DE-D	4VES-7	\$17,450	\$17,960	\$2,680	D / Medium	E	5/8	1-1/8	550
HDSB-0900LQ#DE-D	4TES-9	\$17,710	\$18,170	\$2,680	D / Medium	E	5/8	1-3/8	550
HDSB-1000LQ#DE-D	4PES-12	\$17,980	\$18,380	\$2,680	D / Medium	E	5/8	1-3/8	550
HDSB-1200LQ#FF-D	4NES-14	\$22,020	\$22,510	\$2,680	F / Large	F	5/8	1-3/8	1,250
HDSB-1200LQ#JH-D	4NES-14	\$27,280	\$28,180	\$2,680	J / X-Large	H	5/8	1-3/8	1,575
HDSB-1400LQ#FF-D	4JE-15	\$23,680	\$23,970	\$3,880	F / Large	F	7/8	1-5/8	1,250
HDSB-1400LQ#JH-D	4JE-15	\$28,450	\$28,870	\$3,880	J / X-Large	H	7/8	1-5/8	1,575
HDSB-1600LQ#FF-D	4HE-18	\$23,630	\$23,930	\$3,880	F / Large	F	7/8	1-5/8	1,250
HDSB-1600LQ#JH-D	4HE-18	\$28,920	\$29,340	\$3,880	J / X-Large	H	7/8	1-5/8	1,575

* H-SERIES OPTIONS PAGE LISTS OPTIONS. USE H-SERIES SOFTWARE FOR ADDITIONAL CUSTOMIZATION.

** ORDERS MUST INCLUDE THE FULL MODEL NUMBER INCLUDING CONDENSER AND RECEIVER "HDSB-0200MQKAB"

Options on HDSB units include sealed liquid drier, pumpdown switch, time clock, solid mounted compressor and crating.

(1) Maximum +32° F suction operation for B motor 2 compressors shown. Use E model motor 1 compressor where operation may exceed +20° F for more efficient medium temperature operation. Add \$670 list to B motor pricing for E motors, confirm DOE from tech bulletin and update model number.

HIGH EFFICIENCY H-SERIES PRODUCT DESCRIPTION

Version: July 2020

HDSB - HIGH EFFICIENCY H-SERIES BITZER ECOLINE CONDENSING UNITS

UNIT MODEL	COMPRESSOR MODEL	LIST PRICE		4 Year Extended Compressor Warranty	TECHNICAL SPECIFICATION				SHIP WGT (LBS)
		208/3/60 K	460/3/60 M		Condenser & Cabinet Size	Rcvr Size	Connections		
Bitzer Ecoline - Medium Temperature R-449A									
HDSB-0050MR#BC-A	2KES-05	\$9,850	\$10,300	\$1,020	B / Medium	C	1/2	5/8	550
HDSB-0070MR#BC-A	2JES-07	\$9,940	\$10,390	\$1,020	B / Medium	C	1/2	5/8	550
HDSB-0070MR#DE-A	2JES-07	\$11,980	\$12,500	\$1,020	D / Medium	E	1/2	5/8	550
HDSB-0100MR#BC-D	2HES-1	\$10,120	\$10,570	\$1,020	B / Medium	C	1/2	5/8	550
HDSB-0100MR#DE-A	2HES-1	\$12,170	\$12,680	\$1,020	D / Medium	E	1/2	5/8	550
HDSB-0150MR#BC-D	2FES-2	\$10,160	\$10,610	\$1,020	B / Medium	C	5/8	5/8	550
HDSB-0150MR#DE-D	2FES-2	\$12,200	\$12,720	\$1,020	D / Medium	E	5/8	5/8	550
HDSB-0200MR#BC-D	2EES-2	\$11,040	\$11,490	\$1,410	B / Medium	C	5/8	7/8	550
HDSB-0200MR#DE-D	2EES-2	\$13,080	\$13,600	\$1,410	D / Medium	E	5/8	7/8	550
HDSB-0220MR#DE-D	2DES-2	\$13,330	\$13,850	\$1,410	D / Medium	E	5/8	7/8	550
HDSB-0220MR#FF-D	2DES-2	\$16,610	\$17,250	\$1,410	F / Large	F	5/8	7/8	1,250
HDSB-0300MR#DE-D	2CES-3	\$13,480	\$14,000	\$1,410	D / Medium	E	5/8	7/8	550
HDSB-0300MR#FF-D	2CES-3	\$16,760	\$17,400	\$1,410	F / Large	F	5/8	7/8	1,250
HDSB-0400MR#FF-D	4FES-3	\$17,590	\$18,240	\$1,970	F / Large	F	5/8	7/8	1,250
HDSB-0400MR#JH-D	4FES-3	\$22,850	\$23,620	\$1,970	J / X-Large	H	5/8	7/8	1,575
HDSB-0500MR#FF-D	4EES-4	\$17,810	\$18,450	\$1,970	F / Large	F	5/8	1-1/8	1,250
HDSB-0500MR#JH-D	4EES-4	\$23,070	\$23,830	\$1,970	J / X-Large	H	5/8	1-1/8	1,575
HDSB-0600MR#FF-D	4DES-5	\$18,320	\$18,960	\$1,970	F / Large	F	5/8	1-1/8	1,250
HDSB-0600MR#JH-D	4DES-5	\$23,570	\$24,340	\$1,970	J / X-Large	H	5/8	1-1/8	1,575
HDSB-0650MR#FF-D	4CES-6	\$19,690	\$20,320	\$1,970	F / Large	F	5/8	1-1/8	1,250
HDSB-0650MR#JH-D	4CES-6	\$24,930	\$25,700	\$1,970	J / X-Large	H	5/8	1-1/8	1,575
HDSB-0700MR#FF-D	4VES-7	\$19,950	\$20,590	\$2,680	F / Large	F	7/8	1-1/8	1,250
HDSB-0700MR#JH-D	4VES-7	\$25,200	\$25,970	\$2,680	J / X-Large	H	7/8	1-1/8	1,575
HDSB-0900MR#JH-D	4TES-9	\$25,540	\$26,260	\$2,680	J / X-Large	H	7/8	1-3/8	1,575
HDSB-1000MR#JH-D	4PES-12	\$25,730	\$26,390	\$2,680	J / X-Large	H	7/8	1-3/8	1,575
HDSB-1200MR#JH-D	4NES-14	\$26,450	\$27,070	\$2,680	J / X-Large	H	7/8	1-3/8	1,575

UNIT MODEL	COMPRESSOR MODEL	LIST PRICE		Opt 4-Year Extended Compressor Warranty	TECHNICAL SPECIFICATION				SHIP WGT (LBS)
		208/3/60 K	460/3/60 M		Cabinet Size	Rcvr Size	Connections		
Bitzer Ecoline - Low Temperature R-449A									
HDSB-0050LR#AB-A	2KES-05	\$8,940	\$9,300	\$1,020	A / Small	B	1/2	5/8	400
HDSB-0050LR#BC-A	2KES-05	\$10,270	\$10,690	\$1,020	B / Medium	C	1/2	5/8	550
HDSB-0070LR#AB-D	2JES-07	\$9,080	\$9,390	\$1,020	A / Small	B	1/2	5/8	400
HDSB-0070LR#BC-D	2JES-07	\$10,360	\$10,810	\$1,020	B / Medium	C	1/2	5/8	550
HDSB-0100LR#AB-D	2HES-1	\$9,120	\$9,440	\$1,020	A / Small	B	1/2	5/8	400
HDSB-0100LR#BC-D	2HES-1	\$10,540	\$10,990	\$1,020	B / Medium	C	1/2	5/8	550
HDSB-0150LR#AB-D	2FES-2	\$9,020	\$9,610	\$1,020	A / Small	B	1/2	5/8	400
HDSB-0150LR#BC-D	2FES-2	\$10,580	\$10,890	\$1,020	B / Medium	C	1/2	5/8	550
HDSB-0200LR#AB-D	2EES-2	\$9,960	\$10,270	\$1,410	A / Small	B	1/2	7/8	400
HDSB-0200LR#BC-D	2EES-2	\$11,380	\$11,830	\$1,410	B / Medium	C	1/2	7/8	550
HDSB-0220LR#AB-D	2DES-2	\$10,210	\$10,660	\$1,410	A / Small	B	1/2	7/8	400
HDSB-0220LR#BC-D	2DES-2	\$11,630	\$12,080	\$1,410	B / Medium	C	1/2	7/8	550
HDSB-0300LR#AB-D	2CES-3	\$10,220	\$10,810	\$1,410	A / Small	B	5/8	7/8	400
HDSB-0300LR#BC-D	2CES-3	\$11,780	\$12,230	\$1,410	B / Medium	C	5/8	7/8	550
HDSB-0400LR#BC-D	4FES-3	\$13,140	\$13,590	\$1,970	B / Medium	C	5/8	7/8	550
HDSB-0400LR#DE-D	4FES-3	\$15,190	\$15,700	\$1,970	D / Medium	E	5/8	7/8	550
HDSB-0500LR#BC-D	4EES-4	\$13,340	\$13,790	\$1,970	B / Medium	C	5/8	1-1/8	550
HDSB-0500LR#DE-D	4EES-4	\$15,630	\$15,890	\$1,970	D / Medium	E	5/8	1-1/8	550
HDSB-0600LR#BC-D	4DES-5	\$14,090	\$14,270	\$1,970	B / Medium	C	5/8	1-1/8	550
HDSB-0600LR#DE-D	4DES-5	\$15,870	\$16,380	\$1,970	D / Medium	E	5/8	1-1/8	550
HDSB-0650LR#BC-D	4CES-6	\$16,070	\$16,500	\$1,970	B / Medium	C	5/8	1-1/8	550
HDSB-0650LR#DE-D	4CES-6	\$17,250	\$17,750	\$1,970	D / Medium	E	5/8	1-1/8	550
HDSB-0700LR#BC-D	4VES-7	\$15,400	\$15,710	\$2,680	B / Medium	C	5/8	1-1/8	550
HDSB-0700LR#DE-D	4VES-7	\$17,450	\$17,960	\$2,680	D / Medium	E	5/8	1-1/8	550
HDSB-0900LR#DE-D	4TES-9	\$17,710	\$18,170	\$2,680	D / Medium	E	5/8	1-3/8	550
HDSB-1000LR#DE-D	4PES-12	\$17,980	\$18,380	\$2,680	D / Medium	E	5/8	1-3/8	550
HDSB-1200LR#FF-D	4NES-14	\$22,020	\$22,510	\$2,680	F / Large	F	5/8	1-3/8	1,250
HDSB-1200LR#JH-D	4NES-14	\$27,280	\$28,180	\$2,680	J / X-Large	H	5/8	1-3/8	1,575
HDSB-1400LR#FF-D	4JE-15	\$23,680	\$23,970	\$3,880	F / Large	F	7/8	1-5/8	1,250
HDSB-1400LR#JH-D	4JE-15	\$28,450	\$28,870	\$3,880	J / X-Large	H	7/8	1-5/8	1,575
HDSB-1600LR#FF-D	4HE-18	\$23,630	\$23,930	\$3,880	F / Large	F	7/8	1-5/8	1,250
HDSB-1600LR#JH-D	4HE-18	\$28,920	\$29,340	\$3,880	J / X-Large	H	7/8	1-5/8	1,575

* H-SERIES OPTIONS PAGE LISTS OPTIONS. USE H-SERIES SOFTWARE FOR ADDITIONAL CUSTOMIZATION.

** ORDERS MUST INCLUDE THE FULL MODEL NUMBER INCLUDING CONDENSER AND RECEIVER "HDSB-0200MRKAB"

Options on HDSB units include sealed liquid drier, pumpdown switch, time clock, solid mounted compressor and crating.

(1) Maximum +32° F suction operation for B motor 2 compressors shown. Use E model motor 1 compressor where operation may exceed +20° F for more efficient medium temperature operation. Add \$670 list to B motor pricing for E motors, confirm DOE from tech bulletin and update model number.

HIGH EFFICIENCY H-SERIES PRODUCT DESCRIPTION

Version: July 2020

HDSB - HIGH EFFICIENCY H-SERIES BITZER ECOLINE CONDENSING UNITS

UNIT MODEL	COMPRESSOR MODEL	LIST PRICE		4 Year Extended Compressor Warranty	TECHNICAL SPECIFICATION				SHIP WGT (LBS)
		208/3/60 K	460/3/60 M		Condenser & Cabinet Size	Rcvr Size	Connections		
Bitzer Ecoline - Medium Temperature R-404A									
HDSB-0050MS#BC-D	2KES-05	\$9,850	\$10,300	\$1,020	B / Medium	C	1/2	5/8	550
HDSB-0070MS#BC-D	2JES-07	\$9,940	\$10,390	\$1,020	B / Medium	C	1/2	5/8	550
HDSB-0070MS#DE-D	2JES-07	\$11,980	\$12,500	\$1,020	D / Medium	E	1/2	5/8	550
HDSB-0100MS#BC-D	2HES-1	\$10,120	\$10,570	\$1,020	B / Medium	C	1/2	5/8	550
HDSB-0100MS#DE-D	2HES-1	\$12,170	\$12,680	\$1,020	D / Medium	E	1/2	5/8	550
HDSB-0150MS#BC-D	2FES-2	\$10,160	\$10,610	\$1,020	B / Medium	C	5/8	5/8	550
HDSB-0150MS#DE-D	2FES-2	\$12,200	\$12,720	\$1,020	D / Medium	E	5/8	5/8	550
HDSB-0200MS#BC-D	2EES-2	\$11,040	\$11,490	\$1,410	B / Medium	C	5/8	7/8	550
HDSB-0200MS#DE-D	2EES-2	\$13,080	\$13,600	\$1,410	D / Medium	E	5/8	7/8	550
HDSB-0220MS#DE-D	2DES-2	\$13,330	\$13,850	\$1,410	D / Medium	E	5/8	7/8	550
HDSB-0220MS#FF-D	2DES-2	\$16,610	\$17,250	\$1,410	F / Large	F	5/8	7/8	1,250
HDSB-0300MS#DE-D	2CES-3	\$13,480	\$14,000	\$1,410	D / Medium	E	5/8	7/8	550
HDSB-0300MS#FF-D	2CES-3	\$16,760	\$17,400	\$1,410	F / Large	F	5/8	7/8	1,250
HDSB-0400MS#FF-D	4FES-3	\$17,590	\$18,240	\$1,970	F / Large	F	5/8	7/8	1,250
HDSB-0400MS#JH-D	4FES-3	\$22,850	\$23,620	\$1,970	J / X-Large	H	5/8	7/8	1,575
HDSB-0500MS#FF-D	4EES-4	\$17,810	\$18,450	\$1,970	F / Large	F	5/8	1-1/8	1,250
HDSB-0500MS#JH-D	4EES-4	\$23,070	\$23,830	\$1,970	J / X-Large	H	5/8	1-1/8	1,575
HDSB-0600MS#FF-D	4DES-5	\$18,320	\$18,960	\$1,970	F / Large	F	5/8	1-1/8	1,250
HDSB-0600MS#JH-D	4DES-5	\$23,570	\$24,340	\$1,970	J / X-Large	H	5/8	1-1/8	1,575
HDSB-0650MS#FF-D	4CES-6	\$19,690	\$20,320	\$1,970	F / Large	F	5/8	1-1/8	1,250
HDSB-0650MS#JH-D	4CES-6	\$24,930	\$25,700	\$1,970	J / X-Large	H	5/8	1-1/8	1,575
HDSB-0700MS#FF-D	4VES-7	\$19,950	\$20,590	\$2,680	F / Large	F	7/8	1-1/8	1,250
HDSB-0700MS#JH-D	4VES-7	\$25,200	\$25,970	\$2,680	J / X-Large	H	7/8	1-1/8	1,575
HDSB-0900MS#JH-D	4TES-9	\$25,540	\$26,260	\$2,680	J / X-Large	H	7/8	1-3/8	1,575
HDSB-1000MS#JH-D	4PES-12	\$25,730	\$26,390	\$2,680	J / X-Large	H	7/8	1-3/8	1,575
HDSB-1200MS#JH-A	4NES-14	\$26,450	\$27,070	\$2,680	J / X-Large	H	7/8	1-3/8	1,575

UNIT MODEL	COMPRESSOR MODEL	LIST PRICE		Opt 4-Year Extended Compressor Warranty	TECHNICAL SPECIFICATION				SHIP WGT (LBS)
		208/3/60 K	460/3/60 M		Cabinet Size	Rcvr Size	Connections		
Bitzer Ecoline - Low Temperature R-404A									
HDSB-0050LS#AB-D	2KES-05	\$8,380	\$8,750	\$1,020	A / Small	B	1/2	5/8	400
HDSB-0050LS#BC-D	2KES-05	\$9,710	\$10,130	\$1,020	B / Medium	C	1/2	5/8	550
HDSB-0070LS#AB-D	2JES-07	\$8,520	\$8,830	\$1,020	A / Small	B	1/2	5/8	400
HDSB-0070LS#BC-D	2JES-07	\$9,800	\$10,250	\$1,020	B / Medium	C	1/2	5/8	550
HDSB-0100LS#AB-D	2HES-1	\$8,570	\$8,880	\$1,020	A / Small	B	1/2	5/8	400
HDSB-0100LS#BC-D	2HES-1	\$9,980	\$10,430	\$1,020	B / Medium	C	1/2	5/8	550
HDSB-0150LS#AB-D	2FES-2	\$8,460	\$9,050	\$1,020	A / Small	B	1/2	5/8	400
HDSB-0150LS#BC-D	2FES-2	\$10,020	\$10,330	\$1,020	B / Medium	C	1/2	5/8	550
HDSB-0200LS#AB-D	2EES-2	\$9,400	\$9,710	\$1,410	A / Small	B	1/2	7/8	400
HDSB-0200LS#BC-D	2EES-2	\$10,820	\$11,270	\$1,410	B / Medium	C	1/2	7/8	550
HDSB-0220LS#AB-D	2DES-2	\$9,650	\$10,100	\$1,410	A / Small	B	1/2	7/8	400
HDSB-0220LS#BC-D	2DES-2	\$11,070	\$11,520	\$1,410	B / Medium	C	1/2	7/8	550
HDSB-0300LS#AB-D	2CES-3	\$9,660	\$10,250	\$1,410	A / Small	B	5/8	7/8	400
HDSB-0300LS#BC-D	2CES-3	\$11,220	\$11,670	\$1,410	B / Medium	C	5/8	7/8	550
HDSB-0400LS#BC-D	4FES-3	\$12,590	\$13,040	\$1,970	B / Medium	C	5/8	7/8	550
HDSB-0400LS#DE-D	4FES-3	\$14,630	\$15,150	\$1,970	D / Medium	E	5/8	7/8	550
HDSB-0500LS#BC-D	4EES-4	\$12,780	\$13,230	\$1,970	B / Medium	C	5/8	1-1/8	550
HDSB-0500LS#DE-D	4EES-4	\$15,070	\$15,340	\$1,970	D / Medium	E	5/8	1-1/8	550
HDSB-0600LS#BC-D	4DES-5	\$13,530	\$13,710	\$1,970	B / Medium	C	5/8	1-1/8	550
HDSB-0600LS#DE-D	4DES-5	\$15,320	\$15,820	\$1,970	D / Medium	E	5/8	1-1/8	550
HDSB-0650LS#BC-D	4CES-6	\$15,510	\$15,950	\$1,970	B / Medium	C	5/8	1-1/8	550
HDSB-0650LS#DE-D	4CES-6	\$16,690	\$17,190	\$1,970	D / Medium	E	5/8	1-1/8	550
HDSB-0700LS#BC-D	4VES-7	\$14,850	\$15,150	\$2,680	B / Medium	C	5/8	1-1/8	550
HDSB-0700LS#DE-D	4VES-7	\$16,890	\$17,400	\$2,680	D / Medium	E	5/8	1-1/8	550
HDSB-0900LS#DE-D	4TES-9	\$17,150	\$17,610	\$2,680	D / Medium	E	5/8	1-3/8	550
HDSB-1000LS#DE-D	4PES-12	\$17,420	\$17,820	\$2,680	D / Medium	E	5/8	1-3/8	550
HDSB-1200LS#FF-D	4NES-14	\$21,460	\$21,950	\$2,680	F / Large	F	5/8	1-3/8	1,250
HDSB-1200LS#JH-D	4NES-14	\$26,720	\$27,620	\$2,680	J / X-Large	H	5/8	1-3/8	1,575
HDSB-1400LS#FF-D	4JE-15	\$23,120	\$23,410	\$3,880	F / Large	F	7/8	1-5/8	1,250
HDSB-1400LS#JH-D	4JE-15	\$27,890	\$28,310	\$3,880	J / X-Large	H	7/8	1-5/8	1,575
HDSB-1600LS#FF-A	4HE-18	\$23,070	\$23,370	\$3,880	F / Large	F	7/8	1-5/8	1,250
HDSB-1600LS#JH-D	4HE-18	\$28,360	\$28,780	\$3,880	J / X-Large	H	7/8	1-5/8	1,575

* H-SERIES OPTIONS PAGE LISTS OPTIONS. USE H-SERIES SOFTWARE FOR ADDITIONAL CUSTOMIZATION.

** ORDERS MUST INCLUDE THE FULL MODEL NUMBER INCLUDING CONDENSER AND RECEIVER "HDSB-0200MSKAB"

Options on HDSB units include sealed liquid drier, pumpdown switch, time clock, solid mounted compressor and crating.

(1) Maximum +32°F suction operation for B motor 2 compressors shown. Use E model motor 1 compressor where operation may exceed +20°F for more efficient medium temperature operation.

Prices, product availability, and specifications are subject to change without notice.



HDSB - HIGH EFFICIENCY H-SERIES BITZER ECOLINE CONDENSING UNITS

UNIT MODEL	COMPRESSOR MODEL	LIST PRICE		4 Year Extended Compressor Warranty	TECHNICAL SPECIFICATION				SHIP WGT (LBS)
		208/3/60 K	460/3/60 M		Condenser & Cabinet Size	Rcvr Size	Connections		
							Liquid	Suction	
Bitzer Ecoline - Medium Temperature R-448A									
HDSB-0050MT#BC-A	2KES-05	\$9,850	\$10,300	\$1,020	B / Medium	C	1/2	5/8	550
HDSB-0070MT#BC-A	2JES-07	\$9,940	\$10,390	\$1,020	B / Medium	C	1/2	5/8	550
HDSB-0070MT#DE-A	2JES-07	\$11,980	\$12,500	\$1,020	D / Medium	E	1/2	5/8	550
HDSB-0100MT#BC-D	2HES-1	\$10,120	\$10,570	\$1,020	B / Medium	C	1/2	5/8	550
HDSB-0100MT#DE-A	2HES-1	\$12,170	\$12,680	\$1,020	D / Medium	E	1/2	5/8	550
HDSB-0150MT#BC-D	2FES-2	\$10,160	\$10,610	\$1,020	B / Medium	C	5/8	5/8	550
HDSB-0150MT#DE-D	2FES-2	\$12,200	\$12,720	\$1,020	D / Medium	E	5/8	5/8	550
HDSB-0200MT#BC-D	2EES-2	\$11,040	\$11,490	\$1,410	B / Medium	C	5/8	7/8	550
HDSB-0200MT#DE-D	2EES-2	\$13,080	\$13,600	\$1,410	D / Medium	E	5/8	7/8	550
HDSB-0220MT#DE-D	2DES-2	\$13,330	\$13,850	\$1,410	D / Medium	E	5/8	7/8	550
HDSB-0220MT#FF-D	2DES-2	\$16,610	\$17,250	\$1,410	F / Large	F	5/8	7/8	1,250
HDSB-0300MT#DE-D	2CES-3	\$13,480	\$14,000	\$1,410	D / Medium	E	5/8	7/8	550
HDSB-0300MT#FF-D	2CES-3	\$16,760	\$17,400	\$1,410	F / Large	F	5/8	7/8	1,250
HDSB-0400MT#FF-D	4FES-3	\$17,590	\$18,240	\$1,970	F / Large	F	5/8	7/8	1,250
HDSB-0400MT#JH-D	4FES-3	\$22,850	\$23,620	\$1,970	J / X-Large	H	5/8	7/8	1,575
HDSB-0500MT#FF-D	4EES-4	\$17,810	\$18,450	\$1,970	F / Large	F	5/8	1-1/8	1,250
HDSB-0500MT#JH-D	4EES-4	\$23,070	\$23,830	\$1,970	J / X-Large	H	5/8	1-1/8	1,575
HDSB-0600MT#FF-D	4DES-5	\$18,320	\$18,960	\$1,970	F / Large	F	5/8	1-1/8	1,250
HDSB-0600MT#JH-D	4DES-5	\$23,570	\$24,340	\$1,970	J / X-Large	H	5/8	1-1/8	1,575
HDSB-0650MT#FF-D	4CES-6	\$19,690	\$20,320	\$1,970	F / Large	F	5/8	1-1/8	1,250
HDSB-0650MT#JH-D	4CES-6	\$24,930	\$25,700	\$1,970	J / X-Large	H	5/8	1-1/8	1,575
HDSB-0700MT#FF-D	4VES-7	\$19,950	\$20,590	\$2,680	F / Large	F	7/8	1-1/8	1,250
HDSB-0700MT#JH-D	4VES-7	\$25,200	\$25,970	\$2,680	J / X-Large	H	7/8	1-1/8	1,575
HDSB-0900MT#JH-D	4TES-9	\$25,540	\$26,260	\$2,680	J / X-Large	H	7/8	1-3/8	1,575
HDSB-1000MT#JH-D	4PES-12	\$25,730	\$26,390	\$2,680	J / X-Large	H	7/8	1-3/8	1,575
HDSB-1200MT#JH-D	4NES-14	\$26,450	\$27,070	\$2,680	J / X-Large	H	7/8	1-3/8	1,575

UNIT MODEL	COMPRESSOR MODEL	LIST PRICE		Opt 4-Year Extended Compressor Warranty	TECHNICAL SPECIFICATION				SHIP WGT (LBS)
		208/3/60 K	460/3/60 M		Cabinet Size	Rcvr Size	Connections		
							Liquid	Suction	
Bitzer Ecoline - Low Temperature R-448A									
HDSB-0050LT#AB-A	2KES-05	\$8,940	\$9,300	\$1,020	A / Small	B	1/2	5/8	400
HDSB-0050LT#BC-A	2KES-05	\$10,270	\$10,690	\$1,020	B / Medium	C	1/2	5/8	550
HDSB-0070LT#AB-D	2JES-07	\$9,080	\$9,390	\$1,020	A / Small	B	1/2	5/8	400
HDSB-0070LT#BC-D	2JES-07	\$10,360	\$10,810	\$1,020	B / Medium	C	1/2	5/8	550
HDSB-0100LT#AB-D	2HES-1	\$9,120	\$9,440	\$1,020	A / Small	B	1/2	5/8	400
HDSB-0100LT#BC-D	2HES-1	\$10,540	\$10,990	\$1,020	B / Medium	C	1/2	5/8	550
HDSB-0150LT#AB-D	2FES-2	\$9,020	\$9,610	\$1,020	A / Small	B	1/2	5/8	400
HDSB-0150LT#BC-D	2FES-2	\$10,580	\$10,890	\$1,020	B / Medium	C	1/2	5/8	550
HDSB-0200LT#AB-D	2EES-2	\$9,960	\$10,270	\$1,410	A / Small	B	1/2	7/8	400
HDSB-0200LT#BC-D	2EES-2	\$11,380	\$11,830	\$1,410	B / Medium	C	1/2	7/8	550
HDSB-0220LT#AB-D	2DES-2	\$10,210	\$10,660	\$1,410	A / Small	B	1/2	7/8	400
HDSB-0220LT#BC-D	2DES-2	\$11,630	\$12,080	\$1,410	B / Medium	C	1/2	7/8	550
HDSB-0300LT#AB-D	2CES-3	\$10,220	\$10,810	\$1,410	A / Small	B	5/8	7/8	400
HDSB-0300LT#BC-D	2CES-3	\$11,780	\$12,230	\$1,410	B / Medium	C	5/8	7/8	550
HDSB-0400LT#BC-D	4FES-3	\$13,140	\$13,590	\$1,970	B / Medium	C	5/8	7/8	550
HDSB-0400LT#DE-D	4FES-3	\$15,190	\$15,700	\$1,970	D / Medium	E	5/8	7/8	550
HDSB-0500LT#BC-D	4EES-4	\$13,340	\$13,790	\$1,970	B / Medium	C	5/8	1-1/8	550
HDSB-0500LT#DE-D	4EES-4	\$15,630	\$15,890	\$1,970	D / Medium	E	5/8	1-1/8	550
HDSB-0600LT#BC-D	4DES-5	\$14,090	\$14,270	\$1,970	B / Medium	C	5/8	1-1/8	550
HDSB-0600LT#DE-D	4DES-5	\$15,870	\$16,380	\$1,970	D / Medium	E	5/8	1-1/8	550
HDSB-0650LT#BC-D	4CES-6	\$16,070	\$16,500	\$1,970	B / Medium	C	5/8	1-1/8	550
HDSB-0650LT#DE-D	4CES-6	\$17,250	\$17,750	\$1,970	D / Medium	E	5/8	1-1/8	550
HDSB-0700LT#BC-D	4VES-7	\$15,400	\$15,710	\$2,680	B / Medium	C	5/8	1-1/8	550
HDSB-0700LT#DE-D	4VES-7	\$17,450	\$17,960	\$2,680	D / Medium	E	5/8	1-1/8	550
HDSB-0900LT#DE-D	4TES-9	\$17,710	\$18,170	\$2,680	D / Medium	E	5/8	1-3/8	550
HDSB-1000LT#DE-D	4PES-12	\$17,980	\$18,380	\$2,680	D / Medium	E	5/8	1-3/8	550
HDSB-1200LT#FF-D	4NES-14	\$22,020	\$22,510	\$2,680	F / Large	F	5/8	1-3/8	1,250
HDSB-1200LT#JH-D	4NES-14	\$27,280	\$28,180	\$2,680	J / X-Large	H	5/8	1-3/8	1,575
HDSB-1400LT#FF-D	4JE-15	\$23,680	\$23,970	\$3,880	F / Large	F	7/8	1-5/8	1,250
HDSB-1400LT#JH-D	4JE-15	\$28,450	\$28,870	\$3,880	J / X-Large	H	7/8	1-5/8	1,575
HDSB-1600LT#FF-D	4HE-18	\$23,630	\$23,930	\$3,880	F / Large	F	7/8	1-5/8	1,250
HDSB-1600LT#JH-D	4HE-18	\$28,920	\$29,340	\$3,880	J / X-Large	H	7/8	1-5/8	1,575

* H-SERIES OPTIONS PAGE LISTS OPTIONS. USE H-SERIES SOFTWARE FOR ADDITIONAL CUSTOMIZATION.

** ORDERS MUST INCLUDE THE FULL MODEL NUMBER INCLUDING CONDENSER AND RECEIVER "HDSB-0200MQKAB"

Options on HDSB units include sealed liquid drier, pumpdown switch, time clock, solid mounted compressor and crating.

(1) Maximum +32° F suction operation for B motor 2 compressors shown. Use E model motor 1 compressor where operation may exceed +20° F for more efficient medium temperature operation. Add \$670 list to B motor pricing for E motors, confirm DOE from tech bulletin and update model number..

HIGH EFFICIENCY H-SERIES PRODUCT DESCRIPTION

Version: July 2020

HDSE - HIGH EFFICIENCY H-SERIES BITZER ECOLINE CONDENSING UNITS

UNIT MODEL	COMPRESSOR MODEL	LIST PRICE		4 Year Extended Compressor Warranty	TECHNICAL SPECIFICATION				SHIP WGT (LBS)
		208/3/60 K	460/3/60 M		Condenser & Cabinet Size	Rcvr Size	Connections		
Bitzer Ecoline - Medium Temperature R-407F									
HDSB-0050MF#BC-D	2KES-05	\$9,850	\$10,300	\$1,020	B / Medium	C	1/2	5/8	550
HDSB-0070MF#BC-D	2JES-07	\$9,940	\$10,390	\$1,020	B / Medium	C	1/2	5/8	550
HDSB-0070MF#DE-D	2JES-07	\$11,980	\$12,500	\$1,020	D / Medium	E	1/2	5/8	550
HDSE-0100MF#BC-D	2HES-2	\$11,040	\$11,490	\$1,020	B / Medium	C	1/2	5/8	550
HDSE-0100MF#DE-D	2HES-2	\$13,090	\$13,600	\$1,020	D / Medium	E	1/2	5/8	550
HDSE-0150MF#BC-D	2FES-3	\$11,350	\$11,800	\$1,020	B / Medium	C	5/8	5/8	550
HDSE-0150MF#DE-D	2FES-3	\$13,400	\$13,910	\$1,020	D / Medium	E	5/8	5/8	550
HDSE-0200MF#BC-D	2EES-3	\$11,700	\$12,150	\$1,410	B / Medium	C	5/8	7/8	550
HDSE-0200MF#DE-D	2EES-3	\$13,740	\$14,260	\$1,410	D / Medium	E	5/8	7/8	550
HDSE-0220MF#DE-D	2DES-3	\$14,030	\$13,850	\$1,410	D / Medium	E	5/8	7/8	550
HDSE-0220MF#FF-D	2DES-3	\$17,310	\$17,950	\$1,410	F / Large	F	5/8	7/8	1,250
HDSE-0300MF#DE-D	2CES-4	\$14,480	\$14,990	\$1,410	D / Medium	E	5/8	7/8	550
HDSE-0300MF#FF-D	2CES-4	\$17,750	\$18,390	\$1,410	F / Large	F	5/8	7/8	1,250
HDSE-0400MF#FF-D	4FES-5	\$17,970	\$18,600	\$1,970	F / Large	F	5/8	7/8	1,250
HDSE-0400MF#JH-D	4FES-5	\$23,220	\$23,990	\$1,970	J / X-Large	H	5/8	7/8	1,575
HDSE-0500MF#FF-D	4EES-6	\$18,220	\$18,810	\$1,970	F / Large	F	5/8	1-1/8	1,250
HDSE-0500MF#JH-D	4EES-6	\$23,470	\$24,200	\$1,970	J / X-Large	H	5/8	1-1/8	1,575
HDSE-0600MF#FF-D	4DES-7	\$18,700	\$19,290	\$1,970	F / Large	F	5/8	1-1/8	1,250
HDSE-0600MF#JH-D	4DES-7	\$23,950	\$24,670	\$1,970	J / X-Large	H	5/8	1-1/8	1,575
HDSE-0700MF#FF-D	4VES-10	\$20,300	\$20,830	\$2,680	F / Large	F	7/8	1-1/8	1,250
HDSE-0700MF#JH-D	4VES-10	\$25,560	\$26,220	\$2,680	J / X-Large	H	7/8	1-1/8	1,575
HDSE-0900MF#JH-D	4TES-12	\$25,920	\$26,510	\$2,680	J / X-Large	H	7/8	1-3/8	1,575
HDSE-1000MF#JH-D	4PES-15	\$25,960	\$26,530	\$2,680	J / X-Large	H	7/8	1-3/8	1,575
HDSE-1200MF#JH-D	4NES-20	\$27,320	\$27,790	\$2,680	J / X-Large	H	7/8	1-3/8	1,575

* H-SERIES OPTIONS PAGE LISTS OPTIONS. USE H-SERIES SOFTWARE FOR ADDITIONAL CUSTOMIZATION.

** ORDERS MUST INCLUDE THE FULL MODEL NUMBER INCLUDING CONDENSER AND RECEIVER "HDSE-0200MFKAB"

Options on HDSE units include sealed liquid drier, pumpdown switch, time clock, solid mounted compressor and crating.

- (1) Use "E" Bitzer Motor 1 compressor where operation is above +20° F for more efficient medium temperature operation.
- (2) The "B" Bitzer Motor 2 compressor in the two smallest models is rated for higher temperature operation with no motor change.

Prices, product availability, and specifications are subject to change without notice.



HDSE - HIGH EFFICIENCY H-SERIES BITZER ECOLINE CONDENSING UNITS

UNIT MODEL	COMPRESSOR MODEL	LIST PRICE		4 Year Extended Compressor Warranty	TECHNICAL SPECIFICATION				SHIP WGT (LBS)
		208/3/60 K	460/3/60 M		Condenser & Cabinet Size	Rcvr Size	Connections		
							Liquid	Suction	
Bitzer Ecoline - Medium Temperature R-507A									
HDSB-0050MP#BC-A	2KES-05	\$9,850	\$10,300	\$1,020	B / Medium	C	1/2	5/8	550
HDSB-0070MP#BC-A	2JES-07	\$9,940	\$10,390	\$1,020	B / Medium	C	1/2	5/8	550
HDSB-0070MP#DE-A	2JES-07	\$11,980	\$12,500	\$1,020	D / Medium	E	1/2	5/8	550
HDSE-0100MP#BC-A	2HES-2	\$11,040	\$11,490	\$1,020	B / Medium	C	1/2	5/8	550
HDSE-0100MP#DE-A	2HES-2	\$13,090	\$13,600	\$1,020	D / Medium	E	1/2	5/8	550
HDSE-0150MP#BC-D	2FES-3	\$11,350	\$11,800	\$1,020	B / Medium	C	5/8	5/8	550
HDSE-0150MP#DE-D	2FES-3	\$13,400	\$13,910	\$1,020	D / Medium	E	5/8	5/8	550
HDSE-0200MP#BC-D	2EES-3	\$11,700	\$12,150	\$1,410	B / Medium	C	5/8	7/8	550
HDSE-0200MP#DE-D	2EES-3	\$13,740	\$14,260	\$1,410	D / Medium	E	5/8	7/8	550
HDSE-0220MP#DE-D	2DES-3	\$14,030	\$13,850	\$1,410	D / Medium	E	5/8	7/8	550
HDSE-0220MP#FF-D	2DES-3	\$17,310	\$17,950	\$1,410	F / Large	F	5/8	7/8	1,250
HDSE-0300MP#DE-D	2CES-4	\$14,480	\$14,990	\$1,410	D / Medium	E	5/8	7/8	550
HDSE-0300MP#FF-D	2CES-4	\$17,750	\$18,390	\$1,410	F / Large	F	5/8	7/8	1,250
HDSE-0400MP#FF-D	4FES-5	\$17,970	\$18,600	\$1,970	F / Large	F	5/8	7/8	1,250
HDSE-0400MP#JH-D	4FES-5	\$23,220	\$23,990	\$1,970	J / X-Large	H	5/8	7/8	1,575
HDSE-0500MP#FF-D	4EES-6	\$18,220	\$18,810	\$1,970	F / Large	F	5/8	1-1/8	1,250
HDSE-0500MP#JH-D	4EES-6	\$23,470	\$24,200	\$1,970	J / X-Large	H	5/8	1-1/8	1,575
HDSE-0600MP#FF-D	4DES-7	\$18,700	\$19,290	\$1,970	F / Large	F	5/8	1-1/8	1,250
HDSE-0600MP#JH-D	4DES-7	\$23,950	\$24,670	\$1,970	J / X-Large	H	5/8	1-1/8	1,575
HDSE-0700MP#FF-D	4VES-10	\$20,300	\$20,830	\$2,680	F / Large	F	7/8	1-1/8	1,250
HDSE-0700MP#JH-D	4VES-10	\$25,560	\$26,220	\$2,680	J / X-Large	H	7/8	1-1/8	1,575
HDSE-0900MP#JH-D	4TES-12	\$25,920	\$26,510	\$2,680	J / X-Large	H	7/8	1-3/8	1,575
HDSE-1000MP#JH-D	4PES-15	\$25,960	\$26,530	\$2,680	J / X-Large	H	7/8	1-3/8	1,575
HDSE-1200MP#JH-D	4NES-20	\$27,320	\$27,790	\$2,680	J / X-Large	H	7/8	1-3/8	1,575

* H-SERIES OPTIONS PAGE LISTS OPTIONS. USE H-SERIES SOFTWARE FOR ADDITIONAL CUSTOMIZATION.

** ORDERS MUST INCLUDE THE FULL MODEL NUMBER INCLUDING CONDENSER AND RECEIVER "HDSE-0200MPKAB"

Options on HDSE units include sealed liquid drier, pumpdown switch, time clock, solid mounted compressor and crating.

- (1) Use "E" Bitzer Motor 1 compressor where operation is above +20° F for more efficient medium temperature operation.
- (2) The "B" Bitzer Motor 2 compressor in the two smallest models is rated for higher temperature operation with no motor change.

Prices, product availability, and specifications are subject to change without notice.



HDSE - HIGH EFFICIENCY H-SERIES BITZER ECOLINE CONDENSING UNITS

UNIT MODEL	COMPRESSOR MODEL	LIST PRICE		4 Year Extended Compressor Warranty	TECHNICAL SPECIFICATION				SHIP WGT (LBS)
		208/3/60 K	460/3/60 M		Condenser & Cabinet Size	Rcvr Size	Connections		
Bitzer Ecoline - Medium Temperature R-407A									
HDSB-0050MQ#BC-A	2KES-05	\$9,850	\$10,300	\$1,020	B / Medium	C	1/2	5/8	550
HDSB-0070MQ#BC-D	2JES-07	\$9,940	\$10,390	\$1,020	B / Medium	C	1/2	5/8	550
HDSB-0070MQ#DE-A	2JES-07	\$11,980	\$12,500	\$1,020	D / Medium	E	1/2	5/8	550
HDSE-0100MQ#BC-D	2HES-2	\$11,040	\$11,490	\$1,020	B / Medium	C	1/2	5/8	550
HDSE-0100MQ#DE-D	2HES-2	\$13,090	\$13,600	\$1,020	D / Medium	E	1/2	5/8	550
HDSE-0150MQ#BC-D	2FES-3	\$11,350	\$11,800	\$1,020	B / Medium	C	5/8	5/8	550
HDSE-0150MQ#DE-D	2FES-3	\$13,400	\$13,910	\$1,020	D / Medium	E	5/8	5/8	550
HDSE-0200MQ#BC-D	2EES-3	\$11,700	\$12,150	\$1,410	B / Medium	C	5/8	7/8	550
HDSE-0200MQ#DE-D	2EES-3	\$13,740	\$14,260	\$1,410	D / Medium	E	5/8	7/8	550
HDSE-0220MQ#DE-D	2DES-3	\$14,030	\$13,850	\$1,410	D / Medium	E	5/8	7/8	550
HDSE-0220MQ#FF-D	2DES-3	\$17,310	\$17,950	\$1,410	F / Large	F	5/8	7/8	1,250
HDSE-0300MQ#DE-D	2CES-4	\$14,480	\$14,990	\$1,410	D / Medium	E	5/8	7/8	550
HDSE-0300MQ#FF-D	2CES-4	\$17,750	\$18,390	\$1,410	F / Large	F	5/8	7/8	1,250
HDSE-0400MQ#FF-D	4FES-5	\$17,970	\$18,600	\$1,970	F / Large	F	5/8	7/8	1,250
HDSE-0400MQ#JH-D	4FES-5	\$23,220	\$23,990	\$1,970	J / X-Large	H	5/8	7/8	1,575
HDSE-0500MQ#FF-D	4EES-6	\$18,220	\$18,810	\$1,970	F / Large	F	5/8	1-1/8	1,250
HDSE-0500MQ#JH-D	4EES-6	\$23,470	\$24,200	\$1,970	J / X-Large	H	5/8	1-1/8	1,575
HDSE-0600MQ#FF-D	4DES-7	\$18,700	\$19,290	\$1,970	F / Large	F	5/8	1-1/8	1,250
HDSE-0600MQ#JH-D	4DES-7	\$23,950	\$24,670	\$1,970	J / X-Large	H	5/8	1-1/8	1,575
HDSE-0700MQ#FF-D	4VES-10	\$20,300	\$20,830	\$2,680	F / Large	F	7/8	1-1/8	1,250
HDSE-0700MQ#JH-D	4VES-10	\$25,560	\$26,220	\$2,680	J / X-Large	H	7/8	1-1/8	1,575
HDSE-0900MQ#JH-D	4TES-12	\$25,920	\$26,510	\$2,680	J / X-Large	H	7/8	1-3/8	1,575
HDSE-1000MQ#JH-D	4PES-15	\$25,960	\$26,530	\$2,680	J / X-Large	H	7/8	1-3/8	1,575
HDSE-1200MQ#JH-D	4NES-20	\$27,320	\$27,790	\$2,680	J / X-Large	H	7/8	1-3/8	1,575

* H-SERIES OPTIONS PAGE LISTS OPTIONS. USE H-SERIES SOFTWARE FOR ADDITIONAL CUSTOMIZATION.

** ORDERS MUST INCLUDE THE FULL MODEL NUMBER INCLUDING CONDENSER AND RECEIVER "HDSE-0200MQKAB"

Options on HDSE units include sealed liquid drier, pumpdown switch, time clock, solid mounted compressor and crating.

- (1) Use "E" Bitzer Motor 1 compressor where operation is above +20° F for more efficient medium temperature operation.
- (2) The "B" Bitzer Motor 2 compressor in the two smallest models is rated for higher temperature operation with no motor change.

Prices, product availability, and specifications are subject to change without notice.



HIGH EFFICIENCY H-SERIES PRODUCT DESCRIPTION

Version: July 2020

HDSE - HIGH EFFICIENCY H-SERIES BITZER ECOLINE CONDENSING UNITS

UNIT MODEL	COMPRESSOR MODEL	LIST PRICE		4 Year Extended Compressor Warranty	TECHNICAL SPECIFICATION				SHIP WGT (LBS)
		208/3/60 K	460/3/60 M		Condenser & Cabinet Size	Rcvr Size	Connections		
							Liquid	Suction	
Bitzer Ecoline - Medium Temperature R-449A									
HDSB-0050MR#BC-A	2KES-05	\$9,850	\$10,300	\$1,020	B / Medium	C	1/2	5/8	550
HDSB-0070MR#BC-A	2JES-07	\$9,940	\$10,390	\$1,020	B / Medium	C	1/2	5/8	550
HDSB-0070MR#DE-A	2JES-07	\$11,980	\$12,500	\$1,020	D / Medium	E	1/2	5/8	550
HDSE-0100MR#BC-D	2HES-2	\$11,040	\$11,490	\$1,020	B / Medium	C	1/2	5/8	550
HDSE-0100MR#DE-A	2HES-2	\$13,090	\$13,600	\$1,020	D / Medium	E	1/2	5/8	550
HDSE-0150MR#BC-D	2FES-3	\$11,350	\$11,800	\$1,020	B / Medium	C	5/8	5/8	550
HDSE-0150MR#DE-D	2FES-3	\$13,400	\$13,910	\$1,020	D / Medium	E	5/8	5/8	550
HDSE-0200MR#BC-D	2EES-3	\$11,700	\$12,150	\$1,410	B / Medium	C	5/8	7/8	550
HDSE-0200MR#DE-D	2EES-3	\$13,740	\$14,260	\$1,410	D / Medium	E	5/8	7/8	550
HDSE-0220MR#DE-D	2DES-3	\$14,030	\$13,850	\$1,410	D / Medium	E	5/8	7/8	550
HDSE-0220MR#FF-D	2DES-3	\$17,310	\$17,950	\$1,410	F / Large	F	5/8	7/8	1,250
HDSE-0300MR#DE-D	2CES-4	\$14,480	\$14,990	\$1,410	D / Medium	E	5/8	7/8	550
HDSE-0300MR#FF-D	2CES-4	\$17,750	\$18,390	\$1,410	F / Large	F	5/8	7/8	1,250
HDSE-0400MR#FF-D	4FES-5	\$17,970	\$18,600	\$1,970	F / Large	F	5/8	7/8	1,250
HDSE-0400MR#JH-D	4FES-5	\$23,220	\$23,990	\$1,970	J / X-Large	H	5/8	7/8	1,575
HDSE-0500MR#FF-D	4EES-6	\$18,220	\$18,810	\$1,970	F / Large	F	5/8	1-1/8	1,250
HDSE-0500MR#JH-D	4EES-6	\$23,470	\$24,200	\$1,970	J / X-Large	H	5/8	1-1/8	1,575
HDSE-0600MR#FF-D	4DES-7	\$18,700	\$19,290	\$1,970	F / Large	F	5/8	1-1/8	1,250
HDSE-0600MR#JH-D	4DES-7	\$23,950	\$24,670	\$1,970	J / X-Large	H	5/8	1-1/8	1,575
HDSE-0700MR#FF-D	4VES-10	\$20,300	\$20,830	\$2,680	F / Large	F	7/8	1-1/8	1,250
HDSE-0700MR#JH-D	4VES-10	\$25,560	\$26,220	\$2,680	J / X-Large	H	7/8	1-1/8	1,575
HDSE-0900MR#JH-D	4TES-12	\$25,920	\$26,510	\$2,680	J / X-Large	H	7/8	1-3/8	1,575
HDSE-1000MR#JH-D	4PES-15	\$25,960	\$26,530	\$2,680	J / X-Large	H	7/8	1-3/8	1,575
HDSE-1200MR#JH-D	4NES-20	\$27,320	\$27,790	\$2,680	J / X-Large	H	7/8	1-3/8	1,575

* H-SERIES OPTIONS PAGE LISTS OPTIONS. USE H-SERIES SOFTWARE FOR ADDITIONAL CUSTOMIZATION.

** ORDERS MUST INCLUDE THE FULL MODEL NUMBER INCLUDING CONDENSER AND RECEIVER "HDSE-0200MRKAB"

Options on HDSE units include sealed liquid drier, pumpdown switch, time clock, solid mounted compressor and crating.

- (1) Use "E" Bitzer Motor 1 compressor where operation is above +20° F for more efficient medium temperature operation.
- (2) The "B" Bitzer Motor 2 compressor in the two smallest models is rated for higher temperature operation with no motor change.

Prices, product availability, and specifications are subject to change without notice.



HIGH EFFICIENCY H-SERIES PRODUCT DESCRIPTION

Version: July 2020

HDSE - HIGH EFFICIENCY H-SERIES BITZER ECOLINE CONDENSING UNITS

UNIT MODEL	COMPRESSOR MODEL	LIST PRICE		4 Year Extended Compressor Warranty	TECHNICAL SPECIFICATION				SHIP WGT (LBS)
		208/3/60 K	460/3/60 M		Condenser & Cabinet Size	Rcvr Size	Connections		
							Liquid	Suction	
Bitzer Ecoline - Medium Temperature R-404A									
HDSE-0050MS#BC-D ⁽²⁾	2KES-05	\$9,850	\$10,300	\$1,020	B / Medium	C	1/2	5/8	550
HDSE-0070MS#BC-D ⁽²⁾	2JES-07	\$9,940	\$10,390	\$1,020	B / Medium	C	1/2	5/8	550
HDSE-0070MS#DE-D ⁽²⁾	2JES-07	\$11,980	\$12,500	\$1,020	D / Medium	E	1/2	5/8	550
HDSE-0100MS#BC-D	2HES-2	\$11,040	\$11,490	\$1,020	B / Medium	C	1/2	5/8	550
HDSE-0100MS#DE-D	2HES-2	\$13,090	\$13,600	\$1,020	D / Medium	E	1/2	5/8	550
HDSE-0150MS#BC-D	2FES-3	\$11,350	\$11,800	\$1,020	B / Medium	C	5/8	5/8	550
HDSE-0150MS#DE-D	2FES-3	\$13,400	\$13,910	\$1,020	D / Medium	E	5/8	5/8	550
HDSE-0200MS#BC-D	2EES-3	\$11,700	\$12,150	\$1,410	B / Medium	C	5/8	7/8	550
HDSE-0200MS#DE-D	2EES-3	\$13,740	\$14,260	\$1,410	D / Medium	E	5/8	7/8	550
HDSE-0220MS#DE-D	2DES-3	\$14,030	\$13,850	\$1,410	D / Medium	E	5/8	7/8	550
HDSE-0220MS#FF-D	2DES-3	\$17,310	\$17,950	\$1,410	F / Large	F	5/8	7/8	1,250
HDSE-0300MS#DE-D	2CES-4	\$14,480	\$14,990	\$1,410	D / Medium	E	5/8	7/8	550
HDSE-0300MS#FF-D	2CES-4	\$17,750	\$18,390	\$1,410	F / Large	F	5/8	7/8	1,250
HDSE-0400MS#FF-D	4FES-5	\$17,970	\$18,600	\$1,970	F / Large	F	5/8	7/8	1,250
HDSE-0400MS#JH-D	4FES-5	\$23,220	\$23,990	\$1,970	J / X-Large	H	5/8	7/8	1,575
HDSE-0500MS#FF-D	4EES-6	\$18,220	\$18,810	\$1,970	F / Large	F	5/8	1-1/8	1,250
HDSE-0500MS#JH-D	4EES-6	\$23,470	\$24,200	\$1,970	J / X-Large	H	5/8	1-1/8	1,575
HDSE-0600MS#FF-D	4DES-7	\$18,700	\$19,290	\$1,970	F / Large	F	5/8	1-1/8	1,250
HDSE-0600MS#JH-D	4DES-7	\$23,950	\$24,670	\$1,970	J / X-Large	H	5/8	1-1/8	1,575
HDSE-0700MS#FF-D	4VES-10	\$20,300	\$20,830	\$2,680	F / Large	F	7/8	1-1/8	1,250
HDSE-0700MS#JH-D	4VES-10	\$25,560	\$26,220	\$2,680	J / X-Large	H	7/8	1-1/8	1,575
HDSE-0900MS#JH-D	4TES-12	\$25,920	\$26,510	\$2,680	J / X-Large	H	7/8	1-3/8	1,575
HDSE-1000MS#JH-D	4PES-15	\$25,960	\$26,530	\$2,680	J / X-Large	H	7/8	1-3/8	1,575
HDSE-1200MS#JH-D	4NES-20	\$27,320	\$27,790	\$2,680	J / X-Large	H	7/8	1-3/8	1,575

* H-SERIES OPTIONS PAGE LISTS OPTIONS. USE H-SERIES SOFTWARE FOR ADDITIONAL CUSTOMIZATION.

** ORDERS MUST INCLUDE THE FULL MODEL NUMBER INCLUDING CONDENSER AND RECEIVER "HDSE-0200MSKAB"

Options on HDSE units include sealed liquid drier, pumpdown switch, time clock, solid mounted compressor and crating.

(1) Use "E" Bitzer Motor 1 compressor where operation is above +20° F for more efficient medium temperature operation.

(2) The "B" Bitzer Motor 2 compressor in the two smallest models is rated for higher temperature operation with no motor change.

Prices, product availability, and specifications are subject to change without notice.



HDSE - HIGH EFFICIENCY H-SERIES BITZER ECOLINE CONDENSING UNITS

UNIT MODEL	COMPRESSOR MODEL	LIST PRICE		4 Year Extended Compressor Warranty	TECHNICAL SPECIFICATION				SHIP WGT (LBS)
		208/3/60 K	460/3/60 M		Condenser & Cabinet Size	Rcvr Size	Connections		
							Liquid	Suction	
Bitzer Ecoline - Medium Temperature R-448A									
HDSB-0050MT#BC-A	2KES-05	\$9,850	\$10,300	\$1,020	B / Medium	C	1/2	5/8	550
HDSB-0070MT#BC-A	2JES-07	\$9,940	\$10,390	\$1,020	B / Medium	C	1/2	5/8	550
HDSB-0070MT#DE-A	2JES-07	\$11,980	\$12,500	\$1,020	D / Medium	E	1/2	5/8	550
HDSE-0100MT#BC-D	2HES-2	\$11,040	\$11,490	\$1,020	B / Medium	C	1/2	5/8	550
HDSE-0100MT#DE-A	2HES-2	\$13,090	\$13,600	\$1,020	D / Medium	E	1/2	5/8	550
HDSE-0150MT#BC-D	2FES-3	\$11,350	\$11,800	\$1,020	B / Medium	C	5/8	5/8	550
HDSE-0150MT#DE-D	2FES-3	\$13,400	\$13,910	\$1,020	D / Medium	E	5/8	5/8	550
HDSE-0200MT#BC-D	2EES-3	\$11,700	\$12,150	\$1,410	B / Medium	C	5/8	7/8	550
HDSE-0200MT#DE-D	2EES-3	\$13,740	\$14,260	\$1,410	D / Medium	E	5/8	7/8	550
HDSE-0220MT#DE-D	2DES-3	\$14,030	\$13,850	\$1,410	D / Medium	E	5/8	7/8	550
HDSE-0220MT#FF-D	2DES-3	\$17,310	\$17,950	\$1,410	F / Large	F	5/8	7/8	1,250
HDSE-0300MT#DE-D	2CES-4	\$14,480	\$14,990	\$1,410	D / Medium	E	5/8	7/8	550
HDSE-0300MT#FF-D	2CES-4	\$17,750	\$18,390	\$1,410	F / Large	F	5/8	7/8	1,250
HDSE-0400MT#FF-D	4FES-5	\$17,970	\$18,600	\$1,970	F / Large	F	5/8	7/8	1,250
HDSE-0400MT#JH-D	4FES-5	\$23,220	\$23,990	\$1,970	J / X-Large	H	5/8	7/8	1,575
HDSE-0500MT#FF-D	4EES-6	\$18,220	\$18,810	\$1,970	F / Large	F	5/8	1-1/8	1,250
HDSE-0500MT#JH-D	4EES-6	\$23,470	\$24,200	\$1,970	J / X-Large	H	5/8	1-1/8	1,575
HDSE-0600MT#FF-D	4DES-7	\$18,700	\$19,290	\$1,970	F / Large	F	5/8	1-1/8	1,250
HDSE-0600MT#JH-D	4DES-7	\$23,950	\$24,670	\$1,970	J / X-Large	H	5/8	1-1/8	1,575
HDSE-0700MT#FF-D	4VES-10	\$20,300	\$20,830	\$2,680	F / Large	F	7/8	1-1/8	1,250
HDSE-0700MT#JH-D	4VES-10	\$25,560	\$26,220	\$2,680	J / X-Large	H	7/8	1-1/8	1,575
HDSE-0900MT#JH-D	4TES-12	\$25,920	\$26,510	\$2,680	J / X-Large	H	7/8	1-3/8	1,575
HDSE-1000MT#JH-D	4PES-15	\$25,960	\$26,530	\$2,680	J / X-Large	H	7/8	1-3/8	1,575
HDSE-1200MT#JH-D	4NES-20	\$27,320	\$27,790	\$2,680	J / X-Large	H	7/8	1-3/8	1,575

* H-SERIES OPTIONS PAGE LISTS OPTIONS. USE H-SERIES SOFTWARE FOR ADDITIONAL CUSTOMIZATION.

** ORDERS MUST INCLUDE THE FULL MODEL NUMBER INCLUDING CONDENSER AND RECEIVER "HDSE-0200MTKAB"

Options on HDSE units include sealed liquid drier, pumpdown switch, time clock, solid mounted compressor and crating.

- (1) Use "E" Bitzer Motor 1 compressor where operation is above +20° F for more efficient medium temperature operation.
- (2) The "B" Bitzer Motor 2 compressor in the two smallest models is rated for higher temperature operation with no motor change.

Prices, product availability, and specifications are subject to change without notice.



HIGH EFFICIENCY H-SERIES PRODUCT DESCRIPTION

Version: **July 2020**

HIGH EFFICIENCY H-SERIES OPTIONS (Excludes HTST)

APPLIES TO H MODEL CONDENSING UNITS EQUIPPED WITH BITZER SEMI-HERMETIC AND COPELAND DISCUS, AND SCROLL COMPRESSORS.

Standard Options

- Galvanized Steel Outdoor Housing
- Manual Re-Set High Pressure Control (Encapsulated)
- Adjustable Auto-Reset Low Pressure Control
- Oil Pressure Failure Control (Discus compressors only)
- Adjustable Head Pressure Control
- Crankcase Heater
- Vertical Receiver with Fusible Plug
- Compressor Contactor and Fuses
- Control Circuit with Fuses
- Sealed Liquid Line Drier and Sight Glass
- Pump Down Switch
- UL Listed
- Time Clock for Defrost Scheduling
- Crating for Shipping Protection
- Oversize Condenser
- Ambient Fan Cycling on Multi-Fan Units (one stage)

Available Options (Shown Below)

- Sealed Suction Filter
- Replaceable Core Suction Filter
- Suction Accumulator
- Oil Separator
- Liquid Line Solenoid
- Fused Disconnect
- Phase Monitor
- Fan Cycling
- Electric Defrost Kits
- Electrofin Condenser Coating
- Oversize Receiver

Additional Options Available from Software

- Stackable Indoor Option
- Oil Regulator
- Relief Valve Instead of Fusible Plug
- Oil Level Regulator (with Oil Separator)
- Compressor Unloader (Discus or Bitzer)
- Discharge Check Valve
- Receiver Heat and Insulation
- Suction Line Insulation
- Breaker Instead of Fuses
- Heavy-Duty Base with Horizontal Receiver
- Non-Fused Disconnect
- Replaceable Core Drier
- Hail Guard

Suction Filter		Suction Filter		Suction Accumulator		Oil Separator		Liquid Line Solenoid Valve	
Suction Connection	Non Replaceable	Replaceable Core	Suction Connection	Suction Accumulator	Discharge Connection	List Price	Liquid Connection	List Price	
5/8	\$90	\$260	5/8	\$360	1/2 (S)	\$1,180	1/2	\$250	
7/8	\$90	\$220	7/8	\$360	5/8 (M)	\$1,210	5/8	\$250	
1-1/8	\$90	\$220	1-1/8	\$410	7/8 (L)	\$1,630	7/8	\$250	
1-3/8	\$140	\$230	1-3/8	\$480	1 1/8 (XL)	\$1,810			
1-5/8	\$140	\$240	1-5/8	\$550					
2-1/8	\$330	\$260	2-1/8	\$680					
Defrost Kits*		Price List							
NO DEFROST CLOCK		(\$380)							
Defrost Clock		\$0							
Elec Def Kit- E2 w Defrost Clock		\$1,530		1 phase, <12A fan motor, <48A heater 3 phase, <12A fan motor, <48A heater 3 phase, <12A fan motor, (2)<48A heater					
Elec Def Kit- E3 w Defrost Clock		\$1,970							
Elec Def Kit- E4 w Defrost Clock		\$3,660							

Heat & Insulate Receiver	
Receiver	List Price
ALL SIZES	\$360

Phase Loss Monitor	
Voltage	List Price
208 - 460 V	\$300
575 V	\$300

* Must specify evaporator motor and heater voltage and amperage on orders.

Fused Disconnect (loose)	
Amp / Poles / Voltage	List Price
30A 3P 240 V	\$530
60A 3P 240 V	\$760
100A 3P 240 V	\$1,110
200A 3P 240 V	\$2,130
30A 3P 600 V	\$780
60A 3P 600 V	\$760
100A 3P 600 V	\$1,480
200A 3P 600 V	\$2,130

Fan Cycling			Coil Protection	
Cond Size	# of Stages	LIST PRICE	Cond Size	Electrofin
A	NA	NA	A	\$590
B	NA	NA	B	\$380
D	1 STAGE	INCLUDED	D	\$900
F	1 STAGE	INCLUDED	F	\$2,980
F	2 STAGES	\$270	F	\$3,930
J	1 STAGE	INCLUDED		
J	2 STAGES	\$270		
J	3 STAGES	\$550		

RECEIVER SIZE	CAPACITY (LBS @ 90%)				TO UPGRADE RECEIVER SIZE	CABINET SIZE
	R-404A / R-507A	R-407A / R-407F	R-448A / R-449A			
A 6 x 12	11.1	12.2	11.6		-	SMALL
B 6 x 18	16.7	18.3	17.4		\$210	SMALL
C 6 x 23	21.4	23.4	22.3		\$50	MEDIUM
D 6 x 30	27.9	30.4	29.0		\$40	MEDIUM
E 8-5/8 x 30	53.9	59.0	56.2		\$440	MEDIUM
F 10-3/4 x 30	82.3	90.0	85.8		\$250	LARGE
H 12-3/4 x 30	100.1	109.4	104.3		\$720	LARGE

* CALCULATE COST FOR LARGER RECEIVER - ADD COST FOR EACH SIZE CHANGE
(EXAMPLE - INCREASE SIZE FROM A TO C COST IS \$190 + \$50 = \$240)

FOR OTHER OPTIONS AND CONFIGURATIONS, CONTACT YOU APPLICATION OR SALES ENGINEER.



COMMERCIAL LARGE CONDENSING UNIT PRODUCT DESCRIPTION

Version: **July 2020**

COMMERCIAL LARGE CONDENSING UNIT MODEL KEY

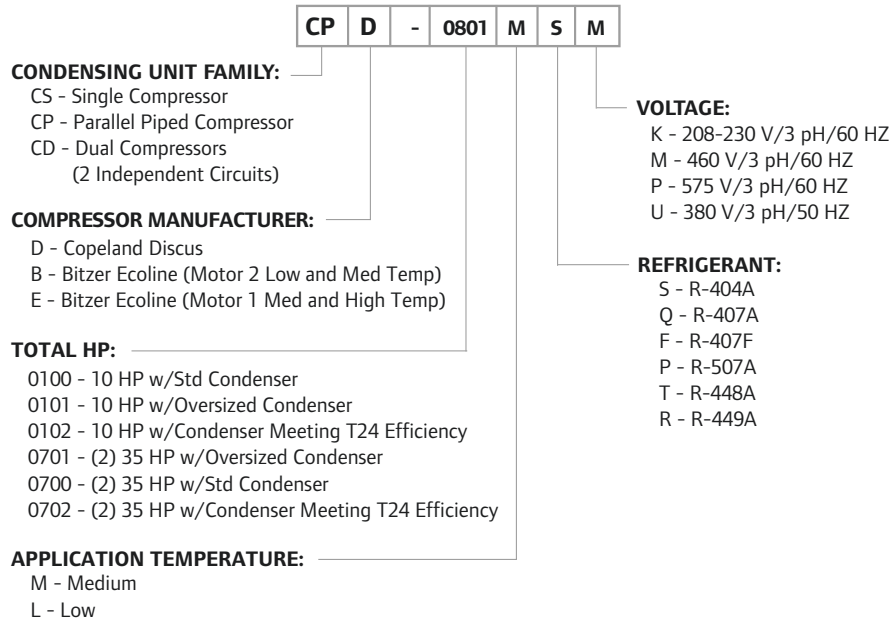

Standard Features

- Replaceable core liquid line filter drier and sight glass.
- Encapsulated high pressure cutout.
- CoreSense Electronic oil pressure control Discus compressors.
- Adjustable low pressure control.
- 230 V control circuit (with transformer as required).
- Adjustable low ambient head pressure control valve.
- Oversized condenser (models pre-engineered).
- Suction accumulator standard on low temperature models.
- 1.5 H.P. ; 1140 RPM fan motors.

Optional Features

- Pressure fan cycling.
- Sealed suction filter.
- Replaceable core suction filter.
- 115 control voltage with transformer.
- Oil separator system to activate flow of oil. (Required for room temperatures of -10° F and below).
- Suction accumulator (medium/high temperature). Recommended for multiple evaporator and variable load applications.
- Heated and Insulated receiver.
- Mounted non-fused disconnect with interlock.
- Electric defrost control options including defrost time clock, evaporator fan motor and defrost heater contactors.
- Air defrost timer.
- Shipped loose fused disconnect (Fuses Not Included).
- Cylinder unloading for compressors (where available).
- Inverter duty suitable fan motors on K and M voltage (requires power block for VFD option).
- Alternate fin materials, such as vinyl and copper, can be specified for adverse environmental conditions.
- Condenser access/clean outdoors.

*Prices, product availability, and specifications
are subject to change without notice.*



COMMERCIAL LARGE CONDENSING UNIT PRODUCT DESCRIPTION

Version: July 2020

CSD - SINGLE COMPRESSOR MODELS with COPELAND DISCUS COMPRESSORS

Single compressor units with one refrigerant and electrical circuit.

Standard Condenser Model	Compressor Model Copeland Discus	95° F Ambient Capacity MBH		Base Unit List Price			Suction filter		Options				Optional Four Year Extended Compressor Warranty	Unit Size	DIMENSIONS (IN)			Ship wt. (lbs)
		@ +25 Evap	@ -20 Evap	230V (K)	460V (M)	575V (P)	Sealed	Replace-able core	Suction Accumulator	Oil Separator	Pressure Fan Cycling	Heated & Insulated Receiver			L	W	H	
CSD-0100MS	3DB3R12ME	107.5	-	\$21,230	\$21,780	\$22,240	\$1,050	\$1,590	\$1,720	\$3,110	NA	\$1,990	\$2,680	A	92	45.25	51.5	1,564
CSD-0150MS	3DS3R17ME	144.4	-	\$23,620	\$24,270	\$24,800	\$1,050	\$1,590	\$1,720	\$3,110	\$1,030	\$1,990	\$4,060	B	146	45.25	51.5	1,834
CSD-0200MS	4DBNR20ME	173.7	-	\$26,680	\$27,550	\$28,130	\$1,050	\$1,590	\$1,720	\$3,110	\$1,030	\$1,990	\$4,940	B	146	45.25	51.5	1,882
CSD-0250MS	4DHNR22ME	193.5	-	\$32,420	\$32,200	\$34,030	\$1,050	\$1,590	\$1,720	\$3,110	\$1,030	\$2,110	\$5,510	B	146	45.25	51.5	2,002
CSD-0300MS	4DJNR28ME	229.8	-	\$40,160	\$41,120	\$41,980	\$1,050	\$1,590	\$1,720	\$3,110	\$1,030	\$2,170	\$6,290	B	146	45.25	51.5	2,106
CSD-0350MS	6DHNR35ME	280.1	-	\$45,730	\$46,740	\$47,740	\$1,050	\$1,590	\$1,720	\$3,190	\$1,640	\$2,240	\$6,350	C	200	45.25	51.5	2,511
CSD-0400MS*	6DJNR40ME	340.6	-	\$50,010	\$51,060	\$52,150	\$1,050	\$1,590	\$2,220	\$3,190	\$1,640	\$2,240	\$7,050	C	200	45.25	51.5	2,820
CSD-0500MS	6DUNR49ML	401.0	-	\$54,780	\$55,860	\$57,030	\$1,460	\$2,070	\$2,220	\$4,900	\$1,030	\$2,240	\$8,950	D	146	90.50	51.5	3,330
CSD-0150LQ*	4DHNF63KE	-	64.7	\$32,170	\$33,020	\$33,710	\$1,050	\$1,590	INCL	\$3,110	NA	\$1,990	\$4,060	A	92	45.25	51.5	1,639
CSD-0220LQ	4DJNF76KE	-	78.5	\$35,350	\$36,340	\$37,110	\$1,050	\$1,590	INCL	\$3,190	\$1,030	\$1,990	\$4,940	B	146	45.25	51.5	1,885
CSD-0270LQ	6DHNF93KE	-	96.0	\$41,260	\$41,130	\$42,010	\$1,050	\$1,590	INCL	\$3,190	\$1,030	\$1,990	\$5,510	B	146	45.25	51.5	2,044
CSD-0300LQ	6DJNF11ME	-	115.5	\$45,620	\$46,000	\$46,970	\$1,050	\$1,590	INCL	\$3,190	\$1,030	\$1,990	\$6,290	B	146	45.25	51.5	2,069
CSD-0150LS*	4DHNF63KE	-	71.1	\$30,770	\$30,900	\$31,540	\$1,050	\$1,590	INCL	\$3,110	NA	\$1,990	\$4,060	A	92	45.25	51.5	1,639
CSD-0220LS	4DJNF76KE	-	86.3	\$33,980	\$34,050	\$34,780	\$1,050	\$1,590	INCL	\$3,190	\$1,030	\$1,990	\$4,940	B	146	45.25	51.5	1,890
CSD-0270LS	6DHNF93KE	-	107.9	\$39,550	\$39,690	\$40,530	\$1,050	\$1,590	INCL	\$3,190	\$1,030	\$2,110	\$5,510	B	146	45.25	51.5	2,056
CSD-0300LS	6DJNF11ME	-	120.3	\$43,840	\$44,790	\$45,720	\$1,050	\$1,590	INCL	\$3,190	\$1,030	\$2,110	\$6,290	B	146	45.25	51.5	2,170

Over Sized Condenser Model	Compressor Model Copeland Discus	95° F Ambient Capacity MBH		Base Unit List Price			Suction filter		Options				Optional Four Year Extended Compressor Warranty	Unit Size	DIMENSIONS (IN)			Ship wt. (lbs)
		@ +25 Evap	@ -20 Evap	230V (K)	460V (M)	575V (P)	Sealed	Replace-able core	Suction Accumulator	Oil Separator	Pressure Fan Cycling	Heated & Insulated Receiver			L	W	H	
CSD-0101MS	3DB3R12ME	111.0	-	\$24,290	\$24,870	\$25,410	\$1,050	\$1,590	\$1,720	\$3,110	\$1,030	\$1,990	\$2,680	B	146	45.25	51.5	1,845
CSD-0151MS	3DS3R17ME	148.7	-	\$25,340	\$26,000	\$26,560	\$1,050	\$1,590	\$1,720	\$3,110	\$1,030	\$2,110	\$4,060	B	146	45.25	51.5	1,930
CSD-0201MS	4DBNR20ME	180.3	-	\$28,400	\$29,280	\$29,900	\$1,050	\$1,590	\$1,720	\$3,110	\$1,030	\$2,110	\$4,940	B	146	45.25	51.5	1,979
CSD-0251MS	4DHNR22ME	203.8	-	\$36,680	\$37,560	\$38,390	\$1,050	\$1,590	\$1,720	\$3,110	\$1,640	\$2,170	\$5,510	C	200	45.25	51.5	2,511
CSD-0301MS	4DJNR28ME	239.7	-	\$42,700	\$43,670	\$44,600	\$1,050	\$1,590	\$1,720	\$3,110	\$1,640	\$2,240	\$6,290	C	200	45.25	51.5	2,584
CSD-0351MS	6DHNR35ME	304.5	-	\$53,490	\$54,490	\$55,650	\$1,050	\$1,590	\$1,720	\$3,190	\$1,030	\$2,240	\$6,350	D	146	90.50	51.5	3,099
CSD-0401MS	6DJNR40ME	354.2	-	\$54,780	\$55,860	\$57,030	\$1,050	\$1,590	\$2,220	\$3,190	\$1,030	\$2,330	\$7,050	D	146	90.50	51.5	3,380
CSD-0501MS	6DUNR49ML	424.0	-	\$62,630	\$63,710	\$64,890	\$1,460	\$2,070	\$2,220	\$4,900	\$1,030	\$2,330	\$7,050	E	200	90.50	51.5	3,380
CSD-0151LQ	4DHNF63KE	-	65.8	\$33,630	\$34,500	\$35,240	\$1,050	\$1,590	INCL	\$3,110	\$1,030	\$1,990	\$4,060	B	146	45.25	51.5	1,934
CSD-0221LQ	4DJNF76KE	-	80.4	\$37,080	\$38,070	\$38,860	\$1,050	\$1,590	INCL	\$3,190	\$1,030	\$1,990	\$4,940	B	146	45.25	51.5	1,947
CSD-0271LQ	6DHNF93KE	-	97.4	\$42,930	\$42,810	\$43,710	\$1,050	\$1,590	INCL	\$3,190	\$1,640	\$1,990	\$5,510	C	200	45.25	51.5	2,427
CSD-0301LQ	6DJNF11ME	-	117.2	\$49,890	\$50,250	\$51,330	\$1,050	\$1,590	INCL	\$3,190	\$1,640	\$2,110	\$6,290	C	200	45.25	51.5	2,580
CSD-0151LS	4DHNF63KE	-	73.1	\$32,260	\$32,360	\$33,050	\$1,050	\$1,590	INCL	\$3,110	\$1,030	\$1,990	\$4,060	B	146	45.25	51.5	1,934
CSD-0221LS	4DJNF76KE	-	88.3	\$35,700	\$35,770	\$36,540	\$1,050	\$1,590	INCL	\$3,190	\$1,030	\$2,110	\$4,940	B	146	45.25	51.5	1,987
CSD-0271LS	6DHNF93KE	-	109.4	\$41,240	\$41,350	\$42,240	\$1,050	\$1,590	INCL	\$3,190	\$1,640	\$2,110	\$5,510	C	200	45.25	51.5	2,439
CSD-0301LS	6DJNF11ME	-	123.4	\$46,370	\$47,320	\$48,310	\$1,050	\$1,590	INCL	\$3,190	\$1,640	\$2,110	\$6,290	C	200	45.25	51.5	2,617

Standard Condenser Model	Compressor Model Copeland Discus	95° F Ambient Capacity MBH		Base Unit List Price			Suction filter		Options				Optional Four Year Extended Compressor Warranty	Unit Size	DIMENSIONS (IN)			Ship wt. (lbs)
		@ +25 Evap	@ -20 Evap	230V (K)	460V (M)	575V (P)	Sealed	Replace-able core	Suction Accumulator	Oil Separator	Pressure Fan Cycling	Heated & Insulated Receiver			L	W	H	
CSD-0102MS	3DB3R12ME	109.7	-	\$21,410	\$21,960	\$22,420	\$1,050	\$1,590	\$1,720	\$3,110	NA	\$1,990	\$2,680	A	92	45.25	51.5	1,594
CSD-0152MS	3DS3R17ME	151.7	-	\$26,320	\$26,980	\$27,510	\$1,050	\$1,590	\$1,720	\$3,110	\$1,030	\$1,990	\$4,060	B	146	45.25	51.5	1,951
CSD-0202MS	4DBNR20ME	183.9	-	\$29,380	\$30,250	\$30,840	\$1,050	\$1,590	\$1,720	\$3,110	\$1,030	\$1,990	\$4,940	B	146	45.25	51.5	1,999
CSD-0252MS	4DHNR22ME	197.4	-	\$34,570	\$34,350	\$36,180	\$1,050	\$1,590	\$1,720	\$3,110	\$1,030	\$2,110	\$5,510	B	146	45.25	51.5	2,061
CSD-0302MS	4DJNR28ME	232.1	-	\$42,020	\$42,970	\$43,840	\$1,050	\$1,590	\$1,720	\$3,110	\$1,030	\$2,170	\$6,290	B	146	45.25	51.5	2,152
CSD-0352MS	6DHNR35ME	285.7	-	\$48,210	\$49,220	\$50,220	\$1,050	\$1,590	\$1,720	\$3,190	\$1,640	\$2,240	\$6,350	C	200	45.25	51.5	2,600
CSD-0502MS	6DUNR49ML	412.0	-	\$59,250	\$60,330	\$61,510	\$1,050	\$1,590	\$2,220	\$3,190	\$1,030	\$2,330	\$7,050	D	146	90.50	51.5	3,380
CSD-0222LQ	4DJNF76KE	-	82	\$38,050	\$39,040	\$39,810	\$1,050	\$1,590	INCL	\$3,190	\$1,030	\$1,990	\$4,940	B	146	45.25	51.5	2,002
CSD-0272LQ	6DHNF93KE	-	98	\$43,410	\$43,280	\$44,160	\$1,050	\$1,590	INCL	\$3,190	\$1,030	\$1,990	\$5,510	B	146	45.25	51.5	2,103
CSD-0302LQ	6DJNF11ME	-	116.6	\$47,780	\$48,150	\$49,120	\$1,050	\$1,590	INCL	\$3,190	\$1,030	\$1,990	\$6,290	B	146	45.25	51.5	2,128
CSD-0222LS	4DJNF76KE	-	90.1	\$36,680	\$36,750	\$37,480	\$1,050	\$1,590	INCL	\$3,190	\$1,030	\$1,990	\$4,940	B	146	45.25	51.5	2,007
CSD-0272LS	6DHNF93KE	-	110.1	\$41,700	\$41,840	\$42,680	\$1,050	\$1,590	INCL	\$3,190	\$1,030	\$2,110	\$5,510	B	146	45.25	51.5	2,115
CSD-0302LS	6DJNF11ME	-	122.7	\$45,990	\$46,950	\$47,870	\$1,050	\$1,590	INCL	\$3,190	\$1,030	\$2,110	\$6,290	B	146	45.25	51.5	2,229

MS - Medium temperature R-404A models would be selected for R-407A (MQ), R-448A (MT), R-449A (MR), R-407F (MF) or R-507 (MP)
 LQ - Low temperature R-407A model would be selected for application with R-448A (LT), R-449A (LR) or R-407F (LF) and would include liquid injection for discharge temperature control
 LS - Low temperature R-404A model would be selected for application with R-507 (LP) and would NOT include liquid injection for discharge temperature control

Models numbers with "2" before the L or M temperature range designation or an * at the end have a condenser that meets California Title 24 efficiency requirements.

Prices, product availability, and specifications are subject to change without notice.



COMMERCIAL LARGE CONDENSING UNIT PRODUCT DESCRIPTION

Version: July 2020

CSB - SINGLE COMPRESSOR MODELS with BITZER ECOLINE COMPRESSORS (Motor 2)

Single compressor units with one refrigerant and electrical circuit.

Standard Condenser Model	Compressor Model	95°F Ambient Capacity MBH		Base Unit List Price			Suction filter		Options				Optional Four Year Extended Compressor Warranty	Unit Size	DIMENSIONS (IN)			Ship wt. (lbs)
		@ +25 Evap	@ -20 Evap	230V (K)	460V (M)	575V (P)	Sealed	Replace-able core	Suction Accum-ulator	Oil Separator	Pressure Fan Cycling	Heated & Insulated Receiver			L	W	H	
CSB-0100MS	4TES-9	106.9	-	\$21,230	\$21,780	\$22,240	\$1,050	\$1,590	\$1,720	\$3,110	NA	\$1,990	\$2,680	A	92	45.25	51.5	1,564
CSB-0150MS	4NES-14	153.7	-	\$23,620	\$24,270	\$24,800	\$1,050	\$1,590	\$1,720	\$3,110	\$1,030	\$1,990	\$4,060	B	146	45.25	51.5	1,834
CSB-0200MS	4JE-15	170.4	-	\$27,720	\$28,590	\$29,170	\$1,050	\$1,590	\$1,720	\$3,110	\$1,030	\$1,990	\$4,940	B	146	45.25	51.5	1,882
CSB-0250MS	4HE-18	200.8	-	\$32,420	\$32,200	\$34,030	\$1,050	\$1,590	\$1,720	\$3,110	\$1,030	\$2,110	\$5,510	B	146	45.25	51.5	2,002
CSB-0300MS	4GE-23	231.9	-	\$40,160	\$41,120	\$41,980	\$1,050	\$1,590	\$1,720	\$3,110	\$1,030	\$2,170	\$6,290	B	146	45.25	51.5	2,106
CSB-0350MS	6HE-28	298.7	-	\$45,730	\$46,740	\$47,740	\$1,050	\$1,590	\$1,720	\$3,190	\$1,640	\$2,240	\$6,350	C	200	45.25	51.5	2,511
CSB-0400MS*	6GE-34	344.7	-	\$50,010	\$51,060	\$52,150	\$1,050	\$1,590	\$2,220	\$3,190	\$1,640	\$2,240	\$7,050	C	200	45.25	51.5	2,820
CSB-0500MS	6FE-44	407.0	-	\$67,230	\$69,430	\$70,910	\$1,460	\$2,070	\$2,220	\$4,900	\$1,640	\$2,240	\$8,950	D	146	90.50	51.5	3,330
CSB-0150LQ*	4HE-18	-	60.6	\$32,170	\$33,020	\$33,710	\$1,050	\$1,590	INCL	\$3,110	NA	\$1,990	\$4,060	A	92	45.25	51.5	1,639
CSB-0220LQ	4GE-23	-	72.1	\$35,350	\$36,340	\$37,110	\$1,050	\$1,590	INCL	\$3,190	\$1,030	\$1,990	\$4,940	B	146	45.25	51.5	1,885
CSB-0270LQ	6HE-28	-	92.7	\$41,260	\$41,130	\$42,010	\$1,050	\$1,590	INCL	\$3,190	\$1,030	\$1,990	\$5,510	B	146	45.25	51.5	2,044
CSB-0300LQ	6GE-34	-	108.8	\$45,620	\$46,000	\$46,970	\$1,050	\$1,590	INCL	\$3,190	\$1,030	\$1,990	\$6,290	B	146	45.25	51.5	2,069
CSB-0150LS*	4HE-18	-	65.9	\$30,770	\$30,900	\$31,540	\$1,050	\$1,590	INCL	\$3,110	NA	\$1,990	\$4,060	A	92	45.25	51.5	1,639
CSB-0220LS	4GE-23	-	78.4	\$33,980	\$34,050	\$34,780	\$1,050	\$1,590	INCL	\$3,190	\$1,030	\$1,990	\$4,940	B	146	45.25	51.5	1,890
CSB-0270LS	6HE-28	-	100.8	\$39,550	\$39,690	\$40,530	\$1,050	\$1,590	INCL	\$3,190	\$1,030	\$2,110	\$5,510	B	146	45.25	51.5	2,056
CSB-0300LS	6GE-34	-	118.3	\$43,840	\$44,790	\$45,720	\$1,050	\$1,590	INCL	\$3,190	\$1,030	\$2,110	\$6,290	B	146	45.25	51.5	2,170

Over Sized Condenser Model	Compressor Model	95°F Ambient Capacity MBH		Base Unit List Price			Suction filter		Options				Optional Four Year Extended Compressor Warranty	Unit Size	DIMENSIONS (IN)			Ship wt. (lbs)
		@ +25 Evap	@ -20 Evap	230V (K)	460V (M)	575V (P)	Sealed	Replace-able core	Suction Accum-ulator	Oil Separator	Pressure Fan Cycling	Heated & Insulated Receiver			L	W	H	
CSB-0101MS	4TES-9	112.8	-	\$24,290	\$24,870	\$25,410	\$1,050	\$1,590	\$1,720	\$3,110	\$1,030	\$1,990	\$2,680	B	146	45.25	51.5	1,845
CSB-0151MS	4NES-14	159.8	-	\$25,340	\$26,000	\$26,560	\$1,050	\$1,590	\$1,720	\$3,110	\$1,030	\$2,110	\$4,060	B	146	45.25	51.5	1,930
CSB-0201MS	4JE-15	177.2	-	\$29,440	\$30,320	\$30,940	\$1,050	\$1,590	\$1,720	\$3,110	\$1,030	\$2,110	\$4,940	B	146	45.25	51.5	1,979
CSB-0251MS	4HE-18	210.1	-	\$36,680	\$37,560	\$38,390	\$1,050	\$1,590	\$1,720	\$3,110	\$1,640	\$2,170	\$5,510	C	200	45.25	51.5	2,511
CSB-0301MS	4GE-23	238.4	-	\$42,700	\$43,670	\$44,600	\$1,050	\$1,590	\$1,720	\$3,110	\$1,640	\$2,240	\$6,290	C	200	45.25	51.5	2,584
CSB-0351MS	6HE-28	312.0	-	\$53,490	\$54,490	\$55,650	\$1,050	\$1,590	\$1,720	\$3,190	\$1,030	\$2,240	\$6,350	D	146	90.50	51.5	3,099
CSB-0401MS	6GE-34	360.0	-	\$54,780	\$55,860	\$57,030	\$1,050	\$1,590	\$2,220	\$3,190	\$1,030	\$2,330	\$7,050	D	146	90.50	51.5	3,380
CSB-0501MS	6FE-44	430.0	-	\$77,220	\$79,400	\$81,110	\$1,460	\$2,070	\$2,220	\$4,900	\$1,640	\$2,330	\$8,950	E	200	90.50	51.5	4,124
CSB-0151LQ	4HE-18	-	62.8	\$33,630	\$34,500	\$35,240	\$1,050	\$1,590	INCL	\$3,110	\$1,030	\$1,990	\$4,060	B	146	45.25	51.5	1,934
CSB-0221LQ	4GE-23	-	74.2	\$37,080	\$38,070	\$38,860	\$1,050	\$1,590	INCL	\$3,190	\$1,030	\$1,990	\$4,940	B	146	45.25	51.5	1,947
CSB-0271LQ	6HE-28	-	93.7	\$42,930	\$42,810	\$43,710	\$1,050	\$1,590	INCL	\$3,190	\$1,640	\$1,990	\$5,510	C	200	45.25	51.5	2,427
CSB-0301LQ	6GE-34	-	111.1	\$49,890	\$50,250	\$51,330	\$1,050	\$1,590	INCL	\$3,190	\$1,640	\$2,110	\$6,290	C	200	45.25	51.5	2,580
CSB-0151LS	4HE-18	-	68.3	\$32,260	\$32,360	\$33,050	\$1,050	\$1,590	INCL	\$3,110	\$1,030	\$1,990	\$4,060	B	146	45.25	51.5	1,934
CSB-0221LS	4GE-23	-	80.7	\$35,700	\$35,770	\$36,540	\$1,050	\$1,590	INCL	\$3,190	\$1,030	\$2,110	\$4,940	B	146	45.25	51.5	1,987
CSB-0271LS	6HE-28	-	101.8	\$41,240	\$41,350	\$42,240	\$1,050	\$1,590	INCL	\$3,190	\$1,640	\$2,110	\$5,510	C	200	45.25	51.5	2,439
CSB-0301LS	6GE-34	-	120.8	\$46,370	\$47,320	\$48,310	\$1,050	\$1,590	INCL	\$3,190	\$1,640	\$2,110	\$6,290	C	200	45.25	51.5	2,617

Standard Condenser Model	Compressor Model	95°F Ambient Capacity MBH		Base Unit List Price			Suction filter		Options				Optional Four Year Extended Compressor Warranty	Unit Size	DIMENSIONS (IN)			Ship wt. (lbs)
		@ +25 Evap	@ -20 Evap	230V (K)	460V (M)	575V (P)	Sealed	Replace-able core	Suction Accum-ulator	Oil Separator	Pressure Fan Cycling	Heated & Insulated Receiver			L	W	H	
CSB-0102MS	4TES-9	109.0	-	\$21,410	\$21,960	\$22,420	\$1,050	\$1,590	\$1,720	\$3,110	NA	\$1,990	\$2,680	A	92	45.25	51.5	1,594
CSB-0152MS	4NES-14	163.0	-	\$26,320	\$26,980	\$27,510	\$1,050	\$1,590	\$1,720	\$3,110	\$1,030	\$1,990	\$4,060	B	146	45.25	51.5	1,951
CSB-0202MS	4JE-15	180.7	-	\$30,420	\$31,290	\$31,880	\$1,050	\$1,590	\$1,720	\$3,110	\$1,030	\$1,990	\$4,940	B	146	45.25	51.5	1,999
CSB-0252MS	4HE-18	204.8	-	\$34,570	\$34,350	\$36,180	\$1,050	\$1,590	\$1,720	\$3,110	\$1,030	\$2,110	\$5,510	B	146	45.25	51.5	2,061
CSB-0302MS	4GE-23	234.2	-	\$42,020	\$42,970	\$43,840	\$1,050	\$1,590	\$1,720	\$3,110	\$1,030	\$2,170	\$6,290	B	146	45.25	51.5	2,152
CSB-0352MS	6HE-28	304.7	-	\$48,210	\$49,220	\$50,220	\$1,050	\$1,590	\$1,720	\$3,190	\$1,640	\$2,240	\$6,350	C	200	45.25	51.5	2,600
CSB-0402MS	6FE-44	418.0	-	\$71,700	\$73,900	\$75,380	\$1,460	\$2,070	\$2,220	\$4,900	\$1,640	\$2,240	\$8,950	D	146	90.50	51.5	3,380
CSB-0222LQ	4GE-23	-	75.7	\$38,050	\$39,040	\$39,810	\$1,050	\$1,590	INCL	\$3,190	\$1,030	\$1,990	\$4,940	B	146	45.25	51.5	2,002
CSB-0272LQ	6HE-28	-	94.6	\$43,410	\$43,280	\$44,160	\$1,050	\$1,590	INCL	\$3,190	\$1,030	\$1,990	\$5,510	B	146	45.25	51.5	2,103
CSB-0302LQ	6GE-34	-	110.5	\$47,780	\$48,150	\$49,120	\$1,050	\$1,590	INCL	\$3,190	\$1,030	\$1,990	\$6,290	B	146	45.25	51.5	2,128
CSB-0222LS	4GE-23	-	82.3	\$36,680	\$36,750	\$37,480	\$1,050	\$1,590	INCL	\$3,190	\$1,030	\$1,990	\$4,940	B	146	45.25	51.5	2,007
CSB-0272LS	6HE-28	-	102.8	\$41,700	\$41,840	\$42,680	\$1,050	\$1,590	INCL	\$3,190	\$1,030	\$2,110	\$5,510	B	146	45.25	51.5	2,115
CSB-0302LS	6GE-34	-	120.1	\$45,990	\$46,950	\$47,870	\$1,050	\$1,590	INCL	\$3,190	\$1,030	\$2,110	\$6,290	B	146	45.25	51.5	2,229

MS - Medium temperature R-404A models would be selected for R-407A (MQ), R-448A (MT), R-449A (MR), R-407F (MF) or R-507 (MP)
 LQ - Low temperature R-407A model would be selected for application with R-448A (LT), R-449A (LR) or R-407F (LF) and would include liquid injection for discharge temperature control
 LS - Low temperature R-404A model would be selected for application with R-507 (LP) and would NOT include liquid injection for discharge temperature control

Models numbers with "2" before the L or M temperature range designation or an * at the end have a condenser that meets California Title 24 efficiency requirements.

Prices, product availability, and specifications are subject to change without notice.



COMMERCIAL LARGE CONDENSING UNIT PRODUCT DESCRIPTION

Version: **July 2020**

CSE - SINGLE COMPRESSOR MODELS with BITZER ECOLINE COMPRESSORS (Motor 1)

Single compressor units with one refrigerant and electrical circuit.

Standard Condenser Model	Compressor Model	95°F Ambient Capacity MBH		Base Unit List Price			Suction filter		Options				Optional Four Year Extended Compressor Warranty	Unit Size	DIMENSIONS (IN)			Ship wt. (lbs)
		@ +25 Evap	@ -20 Evap	230V (K)	460V (M)	575V (P)	Sealed	Replace-able core	Suction Accumulator	Oil Separator	Pressure Fan Cycling	Heated & Insulated Receiver			L	W	H	
CSE-0100MS	4TES-12	106.9	-	\$21,360	\$21,910	\$22,370	\$1,050	\$1,590	\$1,720	\$3,110	NA	\$1,990	\$2,680	A	92	45.25	51.5	1,564
CSE-0150MS	4NES-20	153.7	-	\$23,750	\$24,410	\$24,940	\$1,050	\$1,590	\$1,720	\$3,110	\$1,030	\$1,990	\$4,060	B	146	45.25	51.5	1,834
CSE-0200MS	4JE-22	170.4	-	\$27,850	\$28,720	\$29,310	\$1,050	\$1,590	\$1,720	\$3,110	\$1,030	\$1,990	\$4,940	B	146	45.25	51.5	1,882
CSE-0250MS	4HE-25	200.8	-	\$32,550	\$32,330	\$34,160	\$1,050	\$1,590	\$1,720	\$3,110	\$1,030	\$2,110	\$5,510	B	146	45.25	51.5	2,002
CSE-0300MS	4GE-30	231.9	-	\$40,300	\$41,260	\$42,120	\$1,050	\$1,590	\$1,720	\$3,110	\$1,030	\$2,170	\$6,290	B	146	45.25	51.5	2,106
CSE-0350MS	6HE-35	298.7	-	\$45,860	\$46,870	\$47,870	\$1,050	\$1,590	\$1,720	\$3,190	\$1,640	\$2,240	\$6,350	C	200	45.25	51.5	2,511
CSE-0400MS*	6GE-40	344.7	-	\$50,150	\$51,200	\$52,280	\$1,050	\$1,590	\$2,220	\$3,190	\$1,640	\$2,240	\$7,050	C	200	45.25	51.5	2,820
CSE-0500MS	6FE-50	408.0	-	\$67,360	\$69,570	\$71,040	\$1,460	\$2,070	\$2,220	\$4,900	\$1,640	\$2,240	\$8,950	D	146	90.50	51.5	3,330
CSE-0150LQ*	4HE-25	-	60.6	\$32,300	\$33,160	\$33,840	\$1,050	\$1,590	INCL	\$3,110	NA	\$1,990	\$4,060	A	92	45.25	51.5	1,639
CSE-0220LQ	4GE-30	-	72.1	\$35,480	\$36,470	\$37,240	\$1,050	\$1,590	INCL	\$3,190	\$1,030	\$1,990	\$4,940	B	146	45.25	51.5	1,885
CSE-0270LQ	6HE-35	-	92.7	\$41,390	\$41,270	\$42,140	\$1,050	\$1,590	INCL	\$3,190	\$1,030	\$1,990	\$5,510	B	146	45.25	51.5	2,044
CSE-0300LQ	6GE-40	-	108.8	\$45,760	\$46,130	\$47,100	\$1,050	\$1,590	INCL	\$3,190	\$1,030	\$1,990	\$6,290	B	146	45.25	51.5	2,069
CSE-0150LS*	4HE-25	-	65.9	\$30,910	\$31,030	\$31,680	\$1,050	\$1,590	INCL	\$3,110	NA	\$1,990	\$4,060	A	92	45.25	51.5	1,639
CSE-0220LS	4GE-30	-	78.4	\$34,110	\$34,180	\$34,910	\$1,050	\$1,590	INCL	\$3,190	\$1,030	\$1,990	\$4,940	B	146	45.25	51.5	1,890
CSE-0270LS	6HE-35	-	100.8	\$39,690	\$39,820	\$40,660	\$1,050	\$1,590	INCL	\$3,190	\$1,030	\$2,110	\$5,510	B	146	45.25	51.5	2,056
CSE-0300LS	6GE-40	-	118.3	\$43,970	\$44,930	\$45,850	\$1,050	\$1,590	INCL	\$3,190	\$1,030	\$2,110	\$6,290	B	146	45.25	51.5	2,170

Over Sized Condenser Model	Compressor Model	95°F Ambient Capacity MBH		Base Unit List Price			Suction filter		Options				Optional Four Year Extended Compressor Warranty	Unit Size	DIMENSIONS (IN)			Ship wt. (lbs)
		@ +25 Evap	@ -20 Evap	230V (K)	460V (M)	575V (P)	Sealed	Replace-able core	Suction Accumulator	Oil Separator	Pressure Fan Cycling	Heated & Insulated Receiver			L	W	H	
CSE-0101MS	4TES-12	112.8	-	\$24,430	\$25,000	\$25,540	\$1,050	\$1,590	\$1,720	\$3,110	\$1,030	\$1,990	\$2,680	B	146	45.25	51.5	1,845
CSE-0151MS	4NES-20	159.8	-	\$25,480	\$26,140	\$26,700	\$1,050	\$1,590	\$1,720	\$3,110	\$1,030	\$2,110	\$4,060	B	146	45.25	51.5	1,930
CSE-0201MS	4JE-22	177.2	-	\$29,580	\$30,450	\$31,080	\$1,050	\$1,590	\$1,720	\$3,110	\$1,030	\$2,110	\$4,940	B	146	45.25	51.5	1,979
CSE-0251MS	4HE-25	210.1	-	\$36,820	\$37,700	\$38,520	\$1,050	\$1,590	\$1,720	\$3,110	\$1,640	\$2,170	\$5,510	C	200	45.25	51.5	2,511
CSE-0301MS	4GE-30	238.4	-	\$42,840	\$43,800	\$44,730	\$1,050	\$1,590	\$1,720	\$3,110	\$1,640	\$2,240	\$6,290	C	200	45.25	51.5	2,584
CSE-0351MS	6HE-35	312.0	-	\$53,620	\$54,620	\$55,790	\$1,050	\$1,590	\$1,720	\$3,190	\$1,030	\$2,240	\$6,350	D	146	90.50	51.5	3,099
CSE-0401MS	6GE-40	360.0	-	\$54,910	\$55,990	\$57,170	\$1,050	\$1,590	\$2,220	\$3,190	\$1,030	\$2,330	\$7,050	D	146	90.50	51.5	3,380
CSE-0501MS	6FE-50	431.0	-	\$77,360	\$79,540	\$81,240	\$1,460	\$2,070	\$2,220	\$4,900	\$1,640	\$2,330	\$8,950	E	200	90.50	51.5	4,124
CSE-0151LQ	4HE-25	-	62.8	\$33,770	\$34,630	\$35,370	\$1,050	\$1,590	INCL	\$3,110	\$1,030	\$1,990	\$4,060	B	146	45.25	51.5	1,934
CSE-0221LQ	4GE-30	-	74.2	\$37,210	\$38,210	\$39,000	\$1,050	\$1,590	INCL	\$3,190	\$1,030	\$1,990	\$4,940	B	146	45.25	51.5	1,947
CSE-0271LQ	6HE-35	-	93.7	\$43,070	\$42,940	\$43,850	\$1,050	\$1,590	INCL	\$3,190	\$1,640	\$1,990	\$5,510	C	200	45.25	51.5	2,427
CSE-0301LQ	6GE-40	-	111.1	\$50,020	\$50,390	\$51,470	\$1,050	\$1,590	INCL	\$3,190	\$1,640	\$2,110	\$6,290	C	200	45.25	51.5	2,580
CSE-0151LS	4HE-25	-	68.3	\$32,400	\$32,500	\$33,190	\$1,050	\$1,590	INCL	\$3,110	\$1,030	\$1,990	\$4,060	B	146	45.25	51.5	1,934
CSE-0221LS	4GE-30	-	80.7	\$35,840	\$35,900	\$36,670	\$1,050	\$1,590	INCL	\$3,190	\$1,030	\$2,110	\$4,940	B	146	45.25	51.5	1,987
CSE-0271LS	6HE-35	-	101.8	\$41,370	\$41,490	\$42,380	\$1,050	\$1,590	INCL	\$3,190	\$1,640	\$2,110	\$5,510	C	200	45.25	51.5	2,439
CSE-0301LS	6GE-40	-	120.8	\$46,510	\$47,460	\$48,440	\$1,050	\$1,590	INCL	\$3,190	\$1,640	\$2,110	\$6,290	C	200	45.25	51.5	2,617

Standard Condenser Model	Compressor Model	95°F Ambient Capacity MBH		Base Unit List Price			Suction filter		Options				Optional Four Year Extended Compressor Warranty	Unit Size	DIMENSIONS (IN)			Ship wt. (lbs)
		@ +25 Evap	@ -20 Evap	230V (K)	460V (M)	575V (P)	Sealed	Replace-able core	Suction Accumulator	Oil Separator	Pressure Fan Cycling	Heated & Insulated Receiver			L	W	H	
CSE-0102MS	4TES-12	109.0	-	\$21,550	\$22,100	\$22,560	\$1,050	\$1,590	\$1,720	\$3,110	NA	\$1,990	\$2,680	A	92	45.25	51.5	1,594
CSE-0152MS	4NES-20	163.0	-	\$26,460	\$27,110	\$27,640	\$1,050	\$1,590	\$1,720	\$3,110	\$1,030	\$1,990	\$4,060	B	146	45.25	51.5	1,951
CSE-0202MS	4JE-22	180.7	-	\$30,560	\$31,430	\$32,010	\$1,050	\$1,590	\$1,720	\$3,110	\$1,030	\$1,990	\$4,940	B	146	45.25	51.5	1,999
CSE-0252MS	4HE-25	204.8	-	\$34,700	\$34,490	\$36,320	\$1,050	\$1,590	\$1,720	\$3,110	\$1,030	\$2,110	\$5,510	B	146	45.25	51.5	2,061
CSE-0302MS	4GE-30	234.2	-	\$42,150	\$43,110	\$43,970	\$1,050	\$1,590	\$1,720	\$3,110	\$1,030	\$2,170	\$6,290	B	146	45.25	51.5	2,152
CSE-0352MS	6HE-35	304.7	-	\$48,350	\$49,360	\$50,360	\$1,050	\$1,590	\$1,720	\$3,190	\$1,640	\$2,240	\$6,350	C	200	45.25	51.5	2,600
CSE-0502MS	6FE-50	419.0	-	\$71,830	\$74,040	\$75,510	\$1,460	\$2,070	\$2,220	\$4,900	\$1,640	\$2,240	\$8,950	D	146	90.50	51.5	3,380
CSE-0222LQ	4GE-30	-	75.7	\$38,190	\$39,180	\$39,950	\$1,050	\$1,590	INCL	\$3,190	\$1,030	\$1,990	\$4,940	B	146	45.25	51.5	2,002
CSE-0272LQ	6HE-35	-	94.6	\$43,540	\$43,420	\$44,290	\$1,050	\$1,590	INCL	\$3,190	\$1,030	\$1,990	\$5,510	B	146	45.25	51.5	2,103
CSE-0302LQ	6GE-40	-	110.5	\$47,910	\$48,290	\$49,250	\$1,050	\$1,590	INCL	\$3,190	\$1,030	\$1,990	\$6,290	B	146	45.25	51.5	2,128
CSE-0222LS	4GE-30	-	82.3	\$36,820	\$36,890	\$37,620	\$1,050	\$1,590	INCL	\$3,190	\$1,030	\$1,990	\$4,940	B	146	45.25	51.5	2,007
CSE-0272LS	6HE-35	-	102.8	\$41,840	\$41,970	\$42,820	\$1,050	\$1,590	INCL	\$3,190	\$1,030	\$2,110	\$5,510	B	146	45.25	51.5	2,115
CSE-0302LS	6GE-40	-	120.1	\$46,120	\$47,080	\$48,010	\$1,050	\$1,590	INCL	\$3,190	\$1,030	\$2,110	\$6,290	B	146	45.25	51.5	2,229

MS - Medium temperature R-404A models would be selected for R-407A (MQ), R-448A (MT), R-449A (MR), R-407F (MF) or R-507 (MP)

LQ - Low temperature R-407A model would be selected for application with R-448A (LT), R-449A (LR) or R-407F (LF) and would include liquid injection for discharge temperature control

LS - Low temperature R-404A model would be selected for application with R-507 (LP) and would NOT include liquid injection for discharge temperature control

Models numbers with "2" before the L or M temperature range designation or an * at the end have a condenser that meets California Title 24 efficiency requirements.

Prices, product availability, and specifications are subject to change without notice.



COMMERCIAL LARGE CONDENSING UNIT PRODUCT DESCRIPTION

Version: **July 2020**

CDD - DUAL COMPRESSOR MODELS with COPELAND DISCUS COMPRESSORS

Two independent refrigerant and electrical circuits with single point power feed.

Standard Condenser	Compressor Model	95° F Ambient Capacity MBH		Base Unit List Price		Suction filter		Options				Optional Four Year Extended Compressor Warranty	Unit Size	DIMENSIONS (IN)			Ship wt. (lbs)
		@ +25 Evap	@ -20 Evap	230V (K), 460V (M)	575V (P)	Sealed	Replace-able core	Suction Accum-ulator	Oil Separat or	Pressure Fan Cycling	Heated & Insulated Receiver			L	W	H	
CDD-0100MS	(2) 2DC3R53KE	43.2	-	\$26,570	\$27,140	\$2,110	\$3,330	\$3,400	\$6,200	NA	\$3,960	\$3,180	F	124.75	45.25	51.5	1,748
CDD-0150MS*	(2) 2DL3R78KE	63.7	-	\$36,130	\$36,890	\$2,110	\$3,330	\$3,400	\$6,200	NA	\$3,960	\$4,200	F	124.75	45.25	51.5	1,839
CDD-0160MS	(2) 2DA3R89KE	73.8	-	\$38,830	\$39,690	\$2,110	\$3,330	\$3,400	\$6,200	\$1,030	\$3,960	\$4,200	G	178.75	45.25	51.5	2,378
CDD-0180MS	(2) 3DA3R10ME	87.8	-	\$42,940	\$43,860	\$2,110	\$3,330	\$3,400	\$6,200	\$1,030	\$3,960	\$5,360	G	178.75	45.25	51.5	2,533
CDD-0200MS	(2) 3DB3R12ME	105.4	-	\$48,520	\$49,550	\$2,110	\$3,330	\$3,400	\$6,200	\$1,030	\$3,960	\$5,360	G	178.75	45.25	51.5	2,660
CDD-0240MS*	(2) 3DF3R15ME	122.4	-	\$54,480	-	\$2,110	\$3,330	\$3,400	\$6,200	\$1,030	\$3,960	\$6,120	G	178.75	45.25	51.5	2,725
CDD-0300MS	(2) 3DS3R17ME	141.0	-	\$57,910	\$59,130	\$2,110	\$3,330	\$3,400	\$6,200	\$1,640	\$3,960	\$8,110	H	232.75	45.25	51.5	3,115
CDD-0400MS	(2) 4DBNR20ME	149.7	-	\$59,780	\$60,270	\$2,110	\$3,330	\$3,400	\$6,390	\$1,640	\$3,960	\$9,880	H	232.75	45.25	51.5	3,168
CDD-0500MS*	(2) 4DHNR22ME	188.2	-	\$69,930	\$70,640	\$2,110	\$3,330	\$3,400	\$6,390	\$1,640	\$4,200	\$11,020	H	232.75	45.25	51.5	3,381
CDD-0600MS*	(2) 4DJNR28ME	229.8	-	\$78,900	\$80,570	\$2,110	\$3,330	\$3,400	\$6,390	\$1,640	\$4,360	\$12,590	I	146.00	90.50	51.5	3,716
CDD-0700MS	(2) 6DHNR35ME	280.5	-	\$88,150	\$90,040	\$2,110	\$3,330	\$3,400	\$7,990	\$2,870	\$4,360	\$12,700	J	200.00	90.50	51.5	4,379
CDD-0800MS*	(2) 6DJNR40ME	340.7	-	\$99,300	\$101,400	\$2,110	\$3,330	\$4,430	\$7,990	\$2,870	\$4,480	\$14,100	J	200.00	90.50	51.5	4,942
CDD-0300LQ*	(2) 4DKNF63KE	-	64.7	\$55,620	\$68,610	\$2,110	\$3,330	INCL	\$6,390	\$1,640	\$3,960	\$8,120	G	178.75	45.25	51.5	2,719
CDD-0440LQ	(2) 4DJNF76KE	-	73.5	\$69,210	\$70,680	\$2,110	\$3,330	INCL	\$6,390	\$1,640	\$3,960	\$9,880	H	232.75	45.25	51.5	3,167
CDD-0540LQ*	(2) 6DHNF93KE	-	91.8	\$77,020	\$78,640	\$2,110	\$3,330	INCL	\$6,390	\$1,640	\$4,200	\$11,020	H	232.75	45.25	51.5	3,452
CDD-0600LQ	(2) 6DJNF11ME	-	109	\$84,100	\$85,880	\$2,110	\$3,330	INCL	\$6,390	\$1,640	\$4,200	\$12,590	I	146.00	90.50	51.5	3,765
CDD-0300LS*	(2) 4DKNF63KE	-	71.1	\$55,400	\$65,300	\$2,110	\$3,330	INCL	\$6,390	\$1,640	\$3,960	\$8,120	G	178.75	45.25	51.5	2,719
CDD-0440LS	(2) 4DJNF76KE	-	85.9	\$65,990	\$67,370	\$2,110	\$3,330	INCL	\$6,390	\$1,640	\$3,960	\$9,880	H	232.75	45.25	51.5	3,179
CDD-0540LS*	(2) 6DHNF93KE	-	106.1	\$73,810	\$75,350	\$2,110	\$3,330	INCL	\$6,390	\$1,640	\$4,200	\$11,020	H	232.75	45.25	51.5	3,477
CDD-0600LS	(2) 6DJNF11ME	-	118.8	\$80,880	\$82,610	\$2,110	\$3,330	INCL	\$6,390	\$1,640	\$4,200	\$12,590	I	146.00	90.50	51.5	3,765

Over Sized Condenser	Compressor Model	95° F Ambient Capacity MBH		Base Unit List Price		Suction filter		Options				Optional Four Year Extended Compressor Warranty	Unit Size	DIMENSIONS (IN)			Ship wt. (lbs)
		@ +25 Evap	@ -20 Evap	230V (K), 460V (M)	575V (P)	Sealed	Replace-able core	Suction Accum-ulator	Oil Separat or	Pressure Fan Cycling	Heated & Insulated Receiver			L	W	H	
CDD-0101MS*	(2) 2DC3R53KE	44.9	-	\$29,720	\$30,350	\$2,110	\$3,330	\$3,400	\$6,200	NA	\$3,960	\$3,180	F	124.75	45.25	51.5	1,812
CDD-0151MS	(2) 2DL3R78KE	65.8	-	\$37,600	\$38,420	\$2,110	\$3,330	\$3,400	\$6,200	\$1,030	\$3,960	\$4,200	G	178.75	45.25	51.5	2,371
CDD-0161MS	(2) 2DA3R89KE	75.2	-	\$40,570	\$41,450	\$2,110	\$3,330	\$3,400	\$6,200	\$1,030	\$3,960	\$4,200	G	178.75	45.25	51.5	2,440
CDD-0181MS*	(2) 3DA3R10ME	90.6	-	\$46,390	\$47,370	\$2,110	\$3,330	\$3,400	\$6,200	\$1,030	\$3,960	\$5,360	G	178.75	45.25	51.5	2,729
CDD-0201MS	(2) 3DB3R12ME	108.6	-	\$52,770	\$53,900	\$2,110	\$3,330	\$3,400	\$6,200	\$1,640	\$3,960	\$5,360	H	232.75	45.25	51.5	3,077
CDD-0241MS	(2) 3DF3R15ME	125.5	-	\$57,000	-	\$2,110	\$3,330	\$3,400	\$6,200	\$1,640	\$3,960	\$6,120	H	232.75	45.25	51.5	3,079
CDD-0301MS*	(2) 3DS3R17ME	142.2	-	\$61,360	\$62,670	\$2,110	\$3,330	\$3,400	\$6,200	\$1,640	\$4,200	\$8,110	H	232.75	45.25	51.5	3,277
CDD-0401MS	(2) 4DBNR20ME	156.8	-	\$75,400	\$76,210	\$2,110	\$3,330	\$3,400	\$6,390	\$1,640	\$4,200	\$9,880	I	146.00	90.50	51.5	3,515
CDD-0501MS	(2) 4DHNR22ME	203.8	-	\$80,790	\$82,500	\$2,110	\$3,330	\$3,400	\$6,390	\$2,870	\$4,360	\$11,020	J	200.00	90.50	51.5	4,329
CDD-0601MS	(2) 4DJNR28ME	239.7	-	\$84,960	\$86,770	\$2,110	\$3,330	\$3,400	\$6,390	\$2,870	\$4,480	\$12,590	J	200.00	90.50	51.5	4,474
CDD-0701MS	(2) 6DHNR35ME	304.5	-	\$110,310	\$112,600	\$2,110	\$3,330	\$3,400	\$7,990	\$4,090	\$4,480	\$12,700	K	254.00	90.50	51.5	5,329
CDD-0801MS*	(2) 6DJNR40ME	354.2	-	\$113,010	\$115,360	\$2,110	\$3,330	\$4,430	\$7,990	\$4,090	\$4,640	\$14,100	K	254.00	90.50	51.5	5,895
CDD-0301LQ	(2) 4DKNF63KE	-	67.8	\$60,810	\$70,800	\$2,110	\$3,330	INCL	\$6,390	\$1,640	\$3,960	\$8,120	H	232.75	45.25	51.5	3,212
CDD-0441LQ*	(2) 4DJNF76KE	-	74.0	\$72,640	\$74,180	\$2,110	\$3,330	INCL	\$6,390	\$1,640	\$4,200	\$9,880	H	232.75	45.25	51.5	3,261
CDD-0541LQ*	(2) 6DHNF93KE	-	93.7	\$81,810	\$83,530	\$2,110	\$3,330	INCL	\$6,390	\$1,640	\$4,200	\$11,020	I	146.00	90.50	51.5	3,831
CDD-0601LQ	(2) 6DJNF11ME	-	111.6	\$94,100	\$96,100	\$2,110	\$3,330	INCL	\$6,390	\$2,870	\$4,200	\$12,590	J	200.00	90.50	51.5	4,452
CDD-0301LS	(2) 4DKNF63KE	-	75.3	\$57,590	\$67,490	\$2,110	\$3,330	INCL	\$6,390	\$1,640	\$3,960	\$8,120	H	232.75	45.25	51.5	3,212
CDD-0441LS*	(2) 4DJNF76KE	-	88.3	\$70,280	\$71,780	\$2,110	\$3,330	INCL	\$6,390	\$1,640	\$4,200	\$9,880	H	232.75	45.25	51.5	3,261
CDD-0541LS*	(2) 6DHNF93KE	-	109.0	\$78,580	\$80,240	\$2,110	\$3,330	INCL	\$6,390	\$1,640	\$4,200	\$11,020	I	146.00	90.50	51.5	3,788
CDD-0601LS	(2) 6DJNF11ME	-	123.4	\$90,860	\$92,810	\$2,110	\$3,330	INCL	\$6,390	\$2,870	\$4,200	\$12,590	J	200.00	90.50	51.5	4,527

Over Sized Condenser	Compressor Model	95° F Ambient Capacity MBH		Base Unit List Price		Suction filter		Options				Optional Four Year Extended Compressor Warranty	Unit Size	DIMENSIONS (IN)			Ship wt. (lbs)
		@ +25 Evap	@ -20 Evap	230V (K), 460V (M)	575V (P)	Sealed	Replace-able core	Suction Accum-ulator	Oil Separat or	Pressure Fan Cycling	Heated & Insulated Receiver			L	W	H	
CDD-0162MS	(2) 2DA3R89KE	73.8	-	\$41,540	\$42,390	\$2,110	\$3,330	\$3,400	\$6,200	\$1,030	\$3,960	\$4,200	G	178.75	45.25	51.5	2,495
CDD-0202MS	(2) 3DB3R12ME	105.4	-	\$50,670	\$51,700	\$2,110	\$3,330	\$3,400	\$6,200	\$1,030	\$3,960	\$5,360	G	178.75	45.25	51.5	2,719
CDD-0402MS	(2) 4DBNR20ME	149.7	-	\$62,260	\$62,750	\$2,110	\$3,330	\$3,400	\$6,390	\$1,640	\$3,960	\$9,880	H	232.75	45.25	51.5	3,256
CDD-0702MS	(2) 6DHNR35ME	280.5	-	\$93,130	\$95,020	\$2,110	\$3,330	\$3,400	\$7,990	\$2,870	\$4,360	\$12,700	J	200.00	90.50	51.5	4,494
CDD-0602LQ	(2) 6DJNF11ME	-	109.0	\$88,400	\$90,180	\$2,110	\$3,330	INCL	\$6,390	\$1,640	\$4,200	\$12,590	I	146.00	90.50	51.5	3,895
CDD-0602LS	(2) 6DJNF11ME	-	118.8	\$85,180	\$86,900	\$2,110	\$3,330	INCL	\$6,390	\$1,640	\$4,200	\$12,590	I	146.00	90.50	51.5	3,895

MS - Medium temperature R-404A models would be selected for R-407A (MQ), R-448A (MT), R-449A (MR), R-407F (MF) or R-507 (MP)

LQ - Low temperature R-407A model would be selected for application with R-448A (LT), R-449A (LR) or R-407F (LF) and would include liquid injection for discharge temperature control

LS - Low temperature R-404A model would be selected for application with R-507 (LP) and would NOT include liquid injection for discharge temperature control

Models numbers with "2" before the L or M temperature range designation or an * at the end have a condenser that meets California Title 24 efficiency requirements.

Prices, product availability, and specifications are subject to change without notice.



COMMERCIAL LARGE CONDENSING UNIT PRODUCT DESCRIPTION

Version: July 2020

CDB - DUAL COMPRESSOR MODELS with BITZER ECOLINE COMPRESSORS (Motor 2)

Two independent refrigerant and electrical circuits with single point power feed.

Standard Condenser Model	Compressor Model	95° F Ambient Capacity MBH		Base Unit List Price		Suction filter		Options				Optional Four Year Extended Compressor Warranty	Unit Size	DIMENSIONS (IN)			Ship wt. (lbs)
		@ +25 Evap	@ -20 Evap	230V (K), 460V (M)	575V (P)	Sealed	Replace-able core	Suction Accum-ulator	Oil Separat or	Pressure Fan Cycling	Heated & Insulated Receiver			L	W	H	
CDB-0100MS	(2) 2FES-3	43.9	-	\$26,570	\$27,140	\$2,110	\$3,330	\$3,400	\$6,200	NA	\$3,960	\$3,180	F	124.75	45.25	51.5	1,748
CDB-0150MS*	(2) 2EES-4	66.0	-	\$36,130	\$36,890	\$2,110	\$3,330	\$3,400	\$6,200	NA	\$3,960	\$4,200	F	124.75	45.25	51.5	1,839
CDB-0160MS	(2) 2DES-5	69.3	-	\$38,830	\$39,690	\$2,110	\$3,330	\$3,400	\$6,200	\$1,030	\$3,960	\$4,200	G	178.75	45.25	51.5	2,378
CDB-0180MS	(2) 4CES-6	88.5	-	\$42,940	\$43,860	\$2,110	\$3,330	\$3,400	\$6,200	\$1,030	\$3,960	\$5,360	G	178.75	45.25	51.5	2,533
CDB-0200MS	(2) 4TES-9	106.9	-	\$48,520	\$49,550	\$2,110	\$3,330	\$3,400	\$6,200	\$1,030	\$3,960	\$5,360	G	178.75	45.25	51.5	2,660
CDB-0240MS*	(2) 4PES-12	128.1	-	\$54,480	\$55,640	\$2,110	\$3,330	\$3,400	\$6,200	\$1,030	\$3,960	\$6,120	G	178.75	45.25	51.5	2,725
CDB-0300MS	(2) 4NES-14	150.0	-	\$57,910	\$59,130	\$2,110	\$3,330	\$3,400	\$6,200	\$1,640	\$3,960	\$8,110	H	232.75	45.25	51.5	3,115
CDB-0400MS	(2) 4JE-15	169.2	-	\$59,780	\$60,270	\$2,110	\$3,330	\$3,400	\$6,390	\$1,640	\$3,960	\$9,880	H	232.75	45.25	51.5	3,168
CDB-0500MS*	(2) 4HE-18	195.7	-	\$69,930	\$70,640	\$2,110	\$3,330	\$3,400	\$6,390	\$1,640	\$4,200	\$11,020	H	232.75	45.25	51.5	3,381
CDB-0600MS*	(2) 4GE-23	231.9	-	\$78,900	\$80,570	\$2,110	\$3,330	\$3,400	\$6,390	\$1,640	\$4,360	\$12,590	I	146.00	90.50	51.5	3,776
CDB-0700MS	(2) 6HE-28	298.7	-	\$88,150	\$90,040	\$2,110	\$3,330	\$3,400	\$7,990	\$2,870	\$4,360	\$12,700	J	200.00	90.50	51.5	4,319
CDB-0800MS*	(2) 6GE-34	344.7	-	\$99,300	\$101,400	\$2,110	\$3,330	\$4,430	\$7,990	\$2,870	\$4,480	\$14,100	J	200.00	90.50	51.5	4,942
CDB-0300LQ*	(2) 4HE-18	-	60.6	\$63,160	\$64,650	\$2,110	\$3,330	INCL	\$6,390	\$1,640	\$3,960	\$8,120	G	178.75	45.25	51.5	2,719
CDB-0440LQ	(2) 4GE-23	-	71.7	\$69,210	\$70,680	\$2,110	\$3,330	INCL	\$6,390	\$1,640	\$3,960	\$9,880	H	232.75	45.25	51.5	3,167
CDB-0540LQ*	(2) 6HE-28	-	90.9	\$77,020	\$78,640	\$2,110	\$3,330	INCL	\$6,390	\$1,640	\$4,200	\$11,020	H	232.75	45.25	51.5	3,452
CDB-0600LQ	(2) 6GE-34	-	106.9	\$84,100	\$85,880	\$2,110	\$3,330	INCL	\$6,390	\$1,640	\$4,200	\$12,590	I	146.00	90.50	51.5	3,688
CDB-0300LS*	(2) 4HE-18	-	65.9	\$59,960	\$61,340	\$2,110	\$3,330	INCL	\$6,390	\$1,640	\$3,960	\$8,120	G	178.75	45.25	51.5	2,719
CDB-0440LS	(2) 4GE-23	-	77.9	\$65,990	\$67,370	\$2,110	\$3,330	INCL	\$6,390	\$1,640	\$3,960	\$9,880	H	232.75	45.25	51.5	3,179
CDB-0540LS*	(2) 6HE-28	-	98.8	\$73,810	\$75,350	\$2,110	\$3,330	INCL	\$6,390	\$1,640	\$4,200	\$11,020	H	232.75	45.25	51.5	3,477
CDB-0600LS	(2) 6GE-34	-	116.2	\$80,880	\$82,610	\$2,110	\$3,330	INCL	\$6,390	\$1,640	\$4,200	\$12,590	I	146.00	90.50	51.5	3,765

Over Sized Condenser Model	Compressor Model	95° F Ambient Capacity MBH		Base Unit List Price		Suction filter		Options				Optional Four Year Extended Compressor Warranty	Unit Size	DIMENSIONS (IN)			Ship wt. (lbs)
		@ +25 Evap	@ -20 Evap	230V (K), 460V (M)	575V (P)	Sealed	Replace-able core	Suction Accum-ulator	Oil Separat or	Pressure Fan Cycling	Heated & Insulated Receiver			L	W	H	
CDB-0101MS*	(2) 2FES-3	46.5	-	\$29,720	\$30,350	\$2,110	\$3,330	\$3,400	\$6,200	NA	\$3,960	\$3,180	F	124.75	45.25	51.5	1,812
CDB-0151MS	(2) 2EES-4	69.3	-	\$37,600	\$38,420	\$2,110	\$3,330	\$3,400	\$6,200	\$1,030	\$3,960	\$4,200	G	178.75	45.25	51.5	2,371
CDB-0161MS	(2) 2DES-5	71.0	-	\$40,570	\$41,450	\$2,110	\$3,330	\$3,400	\$6,200	\$1,030	\$3,960	\$4,200	G	178.75	45.25	51.5	2,440
CDB-0181MS*	(2) 4CES-6	92.9	-	\$46,390	\$47,370	\$2,110	\$3,330	\$3,400	\$6,200	\$1,030	\$3,960	\$5,360	G	178.75	45.25	51.5	2,729
CDB-0201MS	(2) 4TES-9	112.2	-	\$52,770	\$53,900	\$2,110	\$3,330	\$3,400	\$6,200	\$1,640	\$3,960	\$5,360	H	232.75	45.25	51.5	3,077
CDB-0241MS	(2) 4PES-12	131.8	-	\$57,000	\$58,220	\$2,110	\$3,330	\$3,400	\$6,200	\$1,640	\$3,960	\$6,120	H	232.75	45.25	51.5	3,079
CDB-0301MS*	(2) 4NES-14	152.7	-	\$63,440	\$64,750	\$2,110	\$3,330	\$3,400	\$6,200	\$1,640	\$4,200	\$8,110	H	232.75	45.25	51.5	3,277
CDB-0401MS	(2) 4JE-15	177.2	-	\$75,400	\$76,210	\$2,110	\$3,330	\$3,400	\$6,390	\$1,640	\$4,200	\$9,880	I	146.00	90.50	51.5	3,515
CDB-0501MS	(2) 4HE-18	210.1	-	\$80,790	\$82,500	\$2,110	\$3,330	\$3,400	\$6,390	\$2,870	\$4,360	\$11,020	J	200.00	90.50	51.5	4,329
CDB-0601MS	(2) 4GE-23	238.4	-	\$84,960	\$86,770	\$2,110	\$3,330	\$3,400	\$6,390	\$2,870	\$4,480	\$12,590	J	200.00	90.50	51.5	4,474
CDB-0701MS	(2) 6HE-28	312.0	-	\$110,310	\$112,600	\$2,110	\$3,330	\$3,400	\$7,990	\$4,090	\$4,480	\$12,700	K	254.00	90.50	51.5	5,329
CDB-0801MS	(2) 6GE-34	360.0	-	\$113,010	\$115,360	\$2,110	\$3,330	\$4,430	\$7,990	\$4,090	\$4,640	\$14,100	K	254.00	90.50	51.5	5,895
CDB-0301LQ	(2) 4HE-18	-	64.7	\$65,270	\$74,180	\$2,110	\$3,330	INCL	\$6,390	\$1,640	\$4,200	\$8,120	H	232.75	45.25	51.5	3,212
CDB-0441LQ*	(2) 4GE-23	-	74.2	\$72,640	\$74,180	\$2,110	\$3,330	INCL	\$6,390	\$1,640	\$4,200	\$9,880	H	232.75	45.25	51.5	3,261
CDB-0541LQ*	(2) 6HE-28	-	94.2	\$81,810	\$83,530	\$2,110	\$3,330	INCL	\$6,390	\$1,640	\$4,200	\$11,020	I	146.00	90.50	51.5	3,831
CDB-0601LQ	(2) 6GE-34	-	111.1	\$94,100	\$96,100	\$2,110	\$3,330	INCL	\$6,390	\$2,870	\$4,200	\$12,590	J	200.00	90.50	51.5	4,452
CDB-0301LS	(2) 4HE-18	-	70.3	\$62,150	\$63,530	\$2,110	\$3,330	INCL	\$6,390	\$1,640	\$4,200	\$8,120	H	232.75	45.25	51.5	3,212
CDB-0441LS*	(2) 4GE-23	-	80.7	\$70,280	\$71,780	\$2,110	\$3,330	INCL	\$6,390	\$1,640	\$4,200	\$9,880	H	232.75	45.25	51.5	3,261
CDB-0541LS*	(2) 6HE-28	-	102.4	\$78,580	\$80,240	\$2,110	\$3,330	INCL	\$6,390	\$1,640	\$4,200	\$11,020	I	146.00	90.50	51.5	3,788
CDB-0601LS	(2) 6GE-34	-	120.8	\$90,860	\$92,810	\$2,110	\$3,330	INCL	\$6,390	\$2,870	\$4,200	\$12,590	J	200.00	90.50	51.5	4,527

Over Sized Condenser Model	Compressor Model	95° F Ambient Capacity MBH		Base Unit List Price		Suction filter		Options				Optional Four Year Extended Compressor Warranty	Unit Size	DIMENSIONS (IN)			Ship wt. (lbs)
		@ +25 Evap	@ -20 Evap	230V (K), 460V (M)	575V (P)	Sealed	Replace-able core	Suction Accum-ulator	Oil Separat or	Pressure Fan Cycling	Heated & Insulated Receiver			L	W	H	
CDB-0162MS	(2) 2DES-5	72.4	-	\$41,540	\$42,390	\$2,110	\$3,330	\$3,400	\$6,200	\$1,030	\$3,960	\$4,200	G	178.75	45.25	51.5	2,495
CDB-0202MS	(2) 4TES-9	109.0	-	\$50,670	\$51,700	\$2,110	\$3,330	\$3,400	\$6,200	\$1,030	\$3,960	\$5,360	G	178.75	45.25	51.5	2,719
CDB-0402MS	(2) 4JE-15	172.6	-	\$64,340	\$64,830	\$2,110	\$3,330	\$3,400	\$6,390	\$1,640	\$3,960	\$9,880	H	232.75	45.25	51.5	3,256
CDB-0702MS	(2) 6HE-28	304.7	-	\$93,130	\$95,020	\$2,110	\$3,330	\$3,400	\$7,990	\$2,870	\$4,360	\$12,700	J	200.00	90.50	51.5	4,494
CDB-0602LQ	(2) 6GE-34	-	109.0	\$88,400	\$90,180	\$2,110	\$3,330	INCL	\$6,390	\$1,640	\$4,200	\$12,590	I	146.00	90.50	51.5	3,895
CDB-0602LS	(2) 6GE-34	-	118.5	\$85,180	\$86,900	\$2,110	\$3,330	INCL	\$6,390	\$1,640	\$4,200	\$12,590	I	146.00	90.50	51.5	3,895

MS - Medium temperature R-404A models would be selected for R-407A (MQ), R-448A (MT), R-449A (MR), R-407F (MF) or R-507 (MP)
 LQ - Low temperature R-407A model would be selected for application with R-448A (LT), R-449A (LR) or R-407F (LF) and would include liquid injection for discharge temperature control
 LS - Low temperature R-404A model would be selected for application with R-507 (LP) and would NOT include liquid injection for discharge temperature control

Models numbers with "2" before the L or M temperature range designation or an * at the end have a condenser that meets California Title 24 efficiency requirements.

Prices, product availability, and specifications are subject to change without notice.



COMMERCIAL LARGE CONDENSING UNIT PRODUCT DESCRIPTION

Version: July 2020

CDE - DUAL COMPRESSOR MODELS with BITZER ECOLINE COMPRESSORS (Motor 1)

Two independent refrigerant and electrical circuits with single point power feed.

Standard Condenser Model	Compressor Model Bitzer Ecoline	95° F Ambient Capacity MBH		Base Unit List Price		Suction filter		Options				Optional Four Year Extended Compressor Warranty	Unit Size	DIMENSIONS (IN)			Ship wt. (lbs)
		@ +25 Evap	@ -20 Evap	230V (K), 460V (M)	575V (P)	Sealed	Replace-able core	Suction Accum-ulator	Oil Separat or	Pressure Fan Cycling	Heated & Insulated Receiver			L	W	H	
CDE-0100MS	(2) 4FES-5	43.9	-	\$26,830	\$27,400	\$2,110	\$3,330	\$3,400	\$6,200	NA	\$3,960	\$3,180	F	124.75	45.25	51.5	1,748
CDE-0150MS*	(2) 4EES-6	66	-	\$36,390	\$37,150	\$2,110	\$3,330	\$3,400	\$6,200	NA	\$3,960	\$4,200	F	124.75	45.25	51.5	1,839
CDE-0160MS	(2) 4DES-7	69.3	-	\$39,090	\$39,950	\$2,110	\$3,330	\$3,400	\$6,200	\$1,030	\$3,960	\$4,200	G	178.75	45.25	51.5	2,378
CDE-0180MS	(2) 4CES-9	88.5	-	\$43,200	\$44,120	\$2,110	\$3,330	\$3,400	\$6,200	\$1,030	\$3,960	\$5,360	G	178.75	45.25	51.5	2,533
CDE-0200MS	(2) 4TES-12	106.9	-	\$48,780	\$49,810	\$2,110	\$3,330	\$3,400	\$6,200	\$1,030	\$3,960	\$5,360	G	178.75	45.25	51.5	2,660
CDE-0240MS*	(2) 4PES-15	128.1	-	\$54,740	\$55,900	\$2,110	\$3,330	\$3,400	\$6,200	\$1,030	\$3,960	\$6,120	G	178.75	45.25	51.5	2,725
CDE-0300MS	(2) 4NES-20	150.0	-	\$58,170	\$59,390	\$2,110	\$3,330	\$3,400	\$6,200	\$1,640	\$3,960	\$8,110	H	232.75	45.25	51.5	3,115
CDE-0400MS	(2) 4JE-22	169.2	-	\$60,040	\$60,530	\$2,110	\$3,330	\$3,400	\$6,390	\$1,640	\$3,960	\$9,880	H	232.75	45.25	51.5	3,168
CDE-0500MS*	(2) 4HE-25	195.7	-	\$70,190	\$70,900	\$2,110	\$3,330	\$3,400	\$6,390	\$1,640	\$4,200	\$11,020	H	232.75	45.25	51.5	3,381
CDE-0600MS*	(2) 4GE-30	231.9	-	\$79,160	\$80,830	\$2,110	\$3,330	\$3,400	\$6,390	\$1,640	\$4,360	\$12,590	I	146.00	90.50	51.5	3,776
CDE-0700MS	(2) 6HE-35	298.7	-	\$88,410	\$90,300	\$2,110	\$3,330	\$3,400	\$7,990	\$2,870	\$4,360	\$12,700	J	200.00	90.50	51.5	4,319
CDE-0800MS*	(2) 6GE-40	344.7	-	\$99,560	\$101,660	\$2,110	\$3,330	\$4,430	\$7,990	\$2,870	\$4,480	\$14,100	J	200.00	90.50	51.5	4,942
CDE-0300LQ*	(2) 4HE-25	-	60.6	\$62,710	\$64,110	\$2,110	\$3,330	INCL	\$6,390	\$1,640	\$3,960	\$8,120	G	178.75	45.25	51.5	2,719
CDE-0440LQ	(2) 4GE-30	-	71.7	\$69,470	\$70,940	\$2,110	\$3,330	INCL	\$6,390	\$1,640	\$3,960	\$9,880	H	232.75	45.25	51.5	3,167
CDE-0540LQ*	(2) 6HE-35	-	90.9	\$77,280	\$78,900	\$2,110	\$3,330	INCL	\$6,390	\$1,640	\$4,200	\$11,020	H	232.75	45.25	51.5	3,452
CDE-0600LQ	(2) 6GE-40	-	106.9	\$84,360	\$86,140	\$2,110	\$3,330	INCL	\$6,390	\$1,640	\$4,200	\$12,590	I	146.00	90.50	51.5	3,688
CDE-0300LS*	(2) 4HE-25	-	65.9	\$59,490	\$60,870	\$2,110	\$3,330	INCL	\$6,390	\$1,640	\$3,960	\$8,120	G	178.75	45.25	51.5	2,719
CDE-0440LS	(2) 4GE-30	-	77.9	\$66,250	\$67,630	\$2,110	\$3,330	INCL	\$6,390	\$1,640	\$3,960	\$9,880	H	232.75	45.25	51.5	3,179
CDE-0540LS*	(2) 6HE-35	-	98.8	\$74,070	\$75,610	\$2,110	\$3,330	INCL	\$6,390	\$1,640	\$4,200	\$11,020	H	232.75	45.25	51.5	3,477
CDE-0600LS	(2) 6GE-40	-	116.2	\$81,140	\$82,870	\$2,110	\$3,330	INCL	\$6,390	\$1,640	\$4,200	\$12,590	I	146.00	90.50	51.5	3,765

Over Sized Condenser Model	Compressor Model Bitzer Ecoline	95° F Ambient Capacity MBH		Base Unit List Price		Suction filter		Options				Optional Four Year Extended Compressor Warranty	Unit Size	DIMENSIONS (IN)			Ship wt. (lbs)
		@ +25 Evap	@ -20 Evap	230V (K), 460V (M)	575V (P)	Sealed	Replace-able core	Suction Accum-ulator	Oil Separat or	Pressure Fan Cycling	Heated & Insulated Receiver			L	W	H	
CDE-0101MS*	(2) 4FES-5	46.5	-	\$29,980	\$30,610	\$2,110	\$3,330	\$3,400	\$6,200	NA	\$3,960	\$3,180	F	124.75	45.25	51.5	1,812
CDE-0151MS	(2) 4EES-6	69.3	-	\$37,860	\$38,680	\$2,110	\$3,330	\$3,400	\$6,200	\$1,030	\$3,960	\$4,200	G	178.75	45.25	51.5	2,371
CDE-0161MS	(2) 4DES-7	71.0	-	\$40,830	\$41,710	\$2,110	\$3,330	\$3,400	\$6,200	\$1,030	\$3,960	\$4,200	G	178.75	45.25	51.5	2,440
CDE-0181MS*	(2) 4CES-9	92.9	-	\$46,650	\$47,630	\$2,110	\$3,330	\$3,400	\$6,200	\$1,030	\$3,960	\$5,360	G	178.75	45.25	51.5	2,729
CDE-0201MS	(2) 4TES-12	112.2	-	\$53,030	\$54,160	\$2,110	\$3,330	\$3,400	\$6,200	\$1,640	\$3,960	\$5,360	H	232.75	45.25	51.5	3,077
CDE-0241MS	(2) 4PES-15	131.8	-	\$57,260	\$58,480	\$2,110	\$3,330	\$3,400	\$6,200	\$1,640	\$3,960	\$6,120	H	232.75	45.25	51.5	3,079
CDE-0301MS*	(2) 4NES-20	152.7	-	\$61,620	\$62,930	\$2,110	\$3,330	\$3,400	\$6,200	\$1,640	\$4,200	\$8,110	H	232.75	45.25	51.5	3,277
CDE-0401MS	(2) 4JE-22	177.2	-	\$75,660	\$76,470	\$2,110	\$3,330	\$3,400	\$6,390	\$1,640	\$4,200	\$9,880	I	146.00	90.50	51.5	3,515
CDE-0501MS	(2) 4HE-25	210.1	-	\$81,050	\$82,760	\$2,110	\$3,330	\$3,400	\$6,390	\$2,870	\$4,360	\$11,020	J	200.00	90.50	51.5	4,329
CDE-0601MS	(2) 4GE-30	238.4	-	\$85,220	\$87,030	\$2,110	\$3,330	\$3,400	\$6,390	\$2,870	\$4,480	\$12,590	J	200.00	90.50	51.5	4,474
CDE-0701MS	(2) 6HE-35	312.0	-	\$110,570	\$112,860	\$2,110	\$3,330	\$3,400	\$7,990	\$4,090	\$4,480	\$12,700	K	254.00	90.50	51.5	5,329
CDE-0801MS	(2) 6GE-40	360.0	-	\$113,270	\$115,620	\$2,110	\$3,330	\$4,430	\$7,990	\$4,090	\$4,640	\$14,100	K	254.00	90.50	51.5	5,895
CDE-0301LQ	(2) 4HE-25	-	64.7	\$64,900	\$66,370	\$2,110	\$3,330	INCL	\$6,390	\$1,640	\$3,960	\$8,120	H	232.75	45.25	51.5	3,212
CDE-0441LQ*	(2) 4GE-30	-	74.2	\$72,900	\$74,440	\$2,110	\$3,330	INCL	\$6,390	\$1,640	\$4,200	\$9,880	H	232.75	45.25	51.5	3,261
CDE-0541LQ*	(2) 6HE-35	-	94.2	\$82,070	\$83,790	\$2,110	\$3,330	INCL	\$6,390	\$1,640	\$4,200	\$11,020	I	146.00	90.50	51.5	3,831
CDE-0601LQ	(2) 6GE-40	-	111.1	\$94,360	\$96,360	\$2,110	\$3,330	INCL	\$6,390	\$2,870	\$4,200	\$12,590	J	200.00	90.50	51.5	4,452
CDE-0301LS	(2) 4HE-25	-	70.3	\$61,680	\$63,060	\$2,110	\$3,330	INCL	\$6,390	\$1,640	\$4,120	\$8,440	H	232.75	45.25	51.5	3,212
CDE-0441LS*	(2) 4GE-30	-	80.7	\$70,540	\$72,040	\$2,110	\$3,330	INCL	\$6,390	\$1,640	\$4,200	\$9,880	H	232.75	45.25	51.5	3,261
CDE-0541LS*	(2) 6HE-35	-	102.4	\$78,840	\$80,500	\$2,110	\$3,330	INCL	\$6,390	\$1,640	\$4,200	\$11,020	I	146.00	90.50	51.5	3,831
CDE-0601LS	(2) 6GE-40	-	120.8	\$91,120	\$93,070	\$2,110	\$3,330	INCL	\$6,390	\$2,870	\$4,200	\$12,590	J	200.00	90.50	51.5	4,452

Over Sized Condenser Model	Compressor Model Bitzer Ecoline	95° F Ambient Capacity MBH		Base Unit List Price		Suction filter		Options				Optional Four Year Extended Compressor Warranty	Unit Size	DIMENSIONS (IN)			Ship wt. (lbs)
		@ +25 Evap	@ -20 Evap	230V (K), 460V (M)	575V (P)	Sealed	Replace-able core	Suction Accum-ulator	Oil Separat or	Pressure Fan Cycling	Heated & Insulated Receiver			L	W	H	
CDE-0162MS	(2) 4DES-7	72.4	-	\$41,800	\$42,650	\$2,110	\$3,330	\$3,400	\$6,200	\$1,030	\$3,960	\$4,200	G	178.75	45.25	51.5	2,495
CDE-0202MS	(2) 4TES-12	109.0	-	\$50,930	\$51,960	\$2,110	\$3,330	\$3,400	\$6,200	\$1,030	\$3,960	\$5,360	G	178.75	45.25	51.5	2,719
CDE-0402MS	(2) 4JE-22	172.6	-	\$62,520	\$63,010	\$2,110	\$3,330	\$3,400	\$6,390	\$1,640	\$3,960	\$9,880	H	232.75	45.25	51.5	3,256
CDE-0702MS	(2) 6HE-35	304.7	-	\$93,390	\$95,280	\$2,110	\$3,330	\$3,400	\$7,990	\$2,870	\$4,360	\$12,700	J	200.00	90.50	51.5	4,494
CDE-0602LQ	(2) 6GE-40	-	109.0	\$88,660	\$90,440	\$2,110	\$3,330	INCL	\$6,390	\$1,640	\$4,200	\$12,590	I	146.00	90.50	51.5	3,895
CDE-0602LS	(2) 6GE-40	-	118.5	\$85,440	\$87,160	\$2,110	\$3,330	INCL	\$6,390	\$1,640	\$4,200	\$12,590	I	146.00	90.50	51.5	3,895

MS - Medium temperature R-404A models would be selected for R-407A (MQ), R-448A (MT), R-449A (MR), R-407F (MF) or R-507 (MP)
 LQ - Low temperature R-407A model would be selected for application with R-448A (LT), R-449A (LR) or R-407F (LF) and would include liquid injection for discharge temperature control
 LS - Low temperature R-404A model would be selected for application with R-507 (LP) and would NOT include liquid injection for discharge temperature control

Models numbers with "2" before the L or M temperature range designation or an * at the end have a condenser that meets California Title 24 efficiency requirements.

Prices, product availability, and specifications are subject to change without notice.



COMMERCIAL LARGE CONDENSING UNIT PRODUCT DESCRIPTION

Version: July 2020

CPD - PARALLEL COMPRESSOR MODELS with COPELAND DISCUS COMPRESSORS

One refrigeration circuit with two parallel piped compressors and one electrical circuit.

Standard Condenser	Compressor Model	95° F Ambient Capacity MBH		Base Unit List Price		Suction filter		Options		Optional Four Year Extended Compressor Warranty	Unit Size	DIMENSIONS (IN)			Ship wt. (lbs)
		@ +25 Evap	@ -20 Evap	230V (K), 460V (M)	575V (P)	Sealed	Replace-able core	Pressure Fan Cycling	Heated & Insulated Receiver			L	W	H	
CPD-0100MS	(2) 2DC3R53KE	88.1	-	\$56,260	\$57,370	\$1,050	\$1,590	\$1,640	\$1,990	\$3,180	F	124.75	45.25	51.5	1,793
CPD-0150MS*	(2) 2DL3R78KE	129.9	-	\$57,920	\$59,530	\$1,050	\$1,590	\$1,640	\$1,990	\$4,200	F	124.75	45.25	51.5	1,884
CPD-0160MS	(2) 2DA3R89KE	150.6	-	\$59,560	\$60,950	\$1,050	\$1,590	\$1,640	\$2,110	\$4,200	G	178.75	45.25	51.5	2,423
CPD-0180MS	(2) 3DA3R10ME	179.1	-	\$60,240	\$61,530	\$1,050	\$1,590	\$1,640	\$2,110	\$5,360	G	178.75	45.25	51.5	2,578
CPD-0200MS	(2) 3DB3R12ME	215.0	-	\$64,290	\$65,680	\$1,050	\$1,590	\$1,640	\$2,170	\$5,360	G	178.75	45.25	51.5	2,705
CPD-0240MS*	(2) 3DF3R15ME	249.7	-	\$64,780	-	\$1,050	\$1,590	\$1,640	\$2,170	\$6,120	G	178.75	45.25	51.5	2,770
CPD-0300MS	(2) 3DS3R17ME	287.6	-	\$69,120	\$71,790	\$1,050	\$1,590	\$1,640	\$2,240	\$8,110	H	232.75	45.25	51.5	3,160
CPD-0400MS	(2) 4DBNR20ME	344.3	-	\$72,520	\$73,640	\$1,050	\$1,590	\$1,640	\$2,240	\$9,880	H	232.75	45.25	51.5	3,213
CPD-0500MS*	(2) 4DHNR22ME	376.3	-	\$77,500	\$79,100	\$1,050	\$1,590	\$1,640	\$2,240	\$11,020	H	232.75	45.25	51.5	3,410
CPD-0600MS*	(2) 4DJNR28ME	459.6	-	\$86,470	\$88,250	\$1,050	\$1,590	\$1,030	\$2,330	\$12,590	I	146.00	90.50	51.5	3,833
CPD-0700MS	(2) 6DHNR35ME	561.0	-	\$95,700	\$97,720	\$1,050	\$1,590	\$1,640	\$2,330	\$12,700	J	200.00	90.50	51.5	4,397
CPD-0800MS	(2) 6DJNR40ME	681.3	-	\$106,850	\$109,100	\$1,050	\$1,590	\$1,640	\$3,040	\$14,100	J	200.00	90.50	51.5	5,058
CPD-0300LQ*	(2) 4DKNF63KE	-	129.4	\$66,170	\$76,280	\$1,050	\$1,590	\$1,640	\$2,050	\$8,120	G	178.75	45.25	51.5	2,737
CPD-0440LQ	(2) 4DJNF76KE	-	156.3	\$76,760	\$78,350	\$1,050	\$1,590	\$1,640	\$2,050	\$9,880	H	232.75	45.25	51.5	3,164
CPD-0540LQ*	(2) 6DHNF93KE	-	188.8	\$84,570	\$86,330	\$1,050	\$1,590	\$1,640	\$2,240	\$11,020	H	232.75	45.25	51.5	3,512
CPD-0600LQ	(2) 6DJNF11ME	-	228.0	\$91,280	\$93,180	\$1,460	\$2,070	\$1,030	\$2,240	\$12,590	I	146.00	90.50	51.5	3,769
CPD-0300LS*	(2) 4DKNF63KE	-	142.2	\$62,550	\$72,590	\$1,460	\$1,590	\$1,640	\$2,050	\$8,120	G	178.75	45.25	51.5	2,737
CPD-0440LS	(2) 4DJNF76KE	-	171.8	\$73,140	\$74,660	\$1,460	\$1,590	\$1,640	\$2,050	\$9,880	H	232.75	45.25	51.5	3,167
CPD-0540LS*	(2) 6DHNF93KE	-	212.1	\$80,960	\$82,650	\$1,460	\$1,590	\$1,640	\$2,240	\$11,020	H	232.75	45.25	51.5	3,453
CPD-0600LS	(2) 6DJNF11ME	-	237.5	\$88,050	\$89,890	\$1,460	\$2,070	\$1,030	\$2,240	\$12,590	I	146.00	90.50	51.5	3,772

Over Sized Condenser	Compressor Model	95° F Ambient Capacity MBH		Base Unit List Price		Suction filter		Options		Optional Four Year Extended Compressor Warranty	Unit Size	DIMENSIONS (IN)			Ship wt. (lbs)
		@ +25 Evap	@ -20 Evap	230V (K), 460V (M)	575V (P)	Sealed	Replace-able core	Pressure Fan Cycling	Heated & Insulated Receiver			L	W	H	
CPD-0101MS*	(2) 2DC3R53KE	91.6	-	\$57,050	\$58,160	\$1,050	\$1,590	\$1,640	\$1,990	\$3,180	F	124.75	45.25	51.5	1,857
CPD-0151MS	(2) 2DL3R78KE	134.2	-	\$59,310	\$60,920	\$1,050	\$1,590	\$1,640	\$2,110	\$4,200	G	178.75	45.25	51.5	2,416
CPD-0161MS	(2) 2DA3R89KE	153.4	-	\$60,510	\$61,900	\$1,050	\$1,590	\$1,640	\$2,110	\$4,200	G	178.75	45.25	51.5	2,485
CPD-0181MS*	(2) 3DA3R10ME	184.8	-	\$61,780	\$63,070	\$1,050	\$1,590	\$1,640	\$2,170	\$5,360	G	178.75	45.25	51.5	2,774
CPD-0201MS	(2) 3DB3R12ME	221.5	-	\$66,770	\$68,160	\$1,050	\$1,590	\$1,640	\$2,170	\$5,360	H	232.75	45.25	51.5	3,122
CPD-0241MS	(2) 3DF3R15ME	256.0	-	\$67,990	-	\$1,050	\$1,590	\$1,640	\$2,170	\$6,120	H	232.75	45.25	51.5	3,124
CPD-0301MS*	(2) 3DS3R17ME	290.1	-	\$69,930	\$72,600	\$1,050	\$1,590	\$1,640	\$2,240	\$8,110	H	232.75	45.25	51.5	3,322
CPD-0401MS	(2) 4DBNR20ME	360.6	-	\$77,860	\$78,980	\$1,050	\$1,590	\$1,640	\$2,330	\$9,880	I	146.00	90.50	51.5	3,560
CPD-0501MS	(2) 4DHNR22ME	407.5	-	\$79,830	\$81,530	\$1,050	\$1,590	\$1,640	\$2,330	\$11,020	J	200.00	90.50	51.5	4,389
CPD-0601MS	(2) 4DJNR28ME	479.4	-	\$92,510	\$94,450	\$1,050	\$1,590	\$1,640	\$2,430	\$12,590	J	200.00	90.50	51.5	4,448
CPD-0701MS	(2) 6DHNR35ME	609.0	-	\$104,000	\$106,140	\$1,460	\$2,070	\$2,260	\$3,040	\$12,700	K	254.00	90.50	51.5	5,412
CPD-0801MS	(2) 6DJNR40ME	708.4	-	\$120,180	\$122,670	\$1,460	\$2,070	\$2,260	\$3,040	\$14,100	K	254.00	90.50	51.5	5,816
CPD-0301LQ	(2) 4DKNF63KE	-	135.5	\$68,360	\$78,470	\$1,050	\$1,590	\$1,640	\$2,050	\$8,120	H	232.75	45.25	51.5	3,320
CPD-0441LQ*	(2) 4DJNF76KE	-	160.7	\$80,220	\$81,870	\$1,050	\$1,590	\$1,640	\$2,240	\$9,880	H	232.75	45.25	51.5	3,320
CPD-0541LQ*	(2) 6DHNF93KE	-	193.9	\$89,370	\$91,220	\$1,050	\$1,590	\$1,030	\$2,330	\$11,020	I	146.00	90.50	51.5	3,823
CPD-0601LQ	(2) 6DJNF11ME	-	234.5	\$101,260	\$103,400	\$1,460	\$2,070	\$1,640	\$2,330	\$12,590	J	200.00	90.50	51.5	4,465
CPD-0301LS	(2) 4DKNF63KE	-	150.6	\$64,740	\$74,780	\$1,460	\$2,070	\$1,030	\$2,050	\$8,120	H	232.75	45.25	51.5	3,320
CPD-0441LS*	(2) 4DJNF76KE	-	176.6	\$77,450	\$79,060	\$1,460	\$2,070	\$1,030	\$2,240	\$9,880	H	232.75	45.25	51.5	3,320
CPD-0541LS*	(2) 6DHNF93KE	-	217.9	\$85,740	\$87,540	\$1,460	\$2,070	\$1,030	\$2,330	\$11,020	I	146.00	90.50	51.5	3,872
CPD-0601LS	(2) 6DJNF11ME	-	246.8	\$98,040	\$100,110	\$1,460	\$2,070	\$1,640	\$2,330	\$12,590	J	200.00	90.50	51.5	4,566

Over Sized Condenser	Compressor Model	95° F Ambient Capacity MBH		Base Unit List Price		Suction filter		Options		Optional Four Year Extended Compressor Warranty	Unit Size	DIMENSIONS (IN)			Ship wt. (lbs)
		@ +25 Evap	@ -20 Evap	230V (K), 460V (M)	575V (P)	Sealed	Replace-able core	Pressure Fan Cycling	Heated & Insulated Receiver			L	W	H	
CPD-0162MS	(2) 2DA3R89KE	156.5	-	\$61,100	\$62,490	\$1,050	\$1,590	\$1,640	\$2,170	\$4,200	G	178.75	45.25	51.5	2,544
CPD-0202MS	(2) 3DB3R12ME	219.3	-	\$63,560	\$64,950	\$1,050	\$1,590	\$1,640	\$2,170	\$5,360	G	178.75	45.25	51.5	2,764
CPD-0402MS	(2) 4DBNR20ME	351.2	-	\$75,700	\$76,820	\$1,050	\$1,590	\$1,640	\$2,240	\$9,880	H	232.75	45.25	51.5	3,301
CPD-0702MS	(2) 6DHNR35ME	572.2	-	\$100,680	\$102,690	\$1,050	\$1,590	\$1,640	\$2,330	\$12,700	J	200.00	90.50	51.5	4,572
CPD-0602LQ	(2) 6DJNF11ME	-	232.6	\$95,580	\$97,480	\$1,460	\$2,070	\$1,030	\$2,240	\$12,590	I	146.00	90.50	51.5	3,899
CPD-0602LS	(2) 6DJNF11ME	-	242.3	\$92,340	\$94,180	\$1,460	\$2,070	\$1,030	\$2,240	\$12,590	I	146.00	90.50	51.5	3,902

ALL PARALLEL UNITS INCLUDE SUCTION ACCUMULATOR AND OIL SEPARATOR.

MS - Medium temperature R-404A models would be selected for R-407A (MQ), R-448A (MT), R-449A (MR), R-407F (MF) or R-507 (MP)

LQ - Low temperature R-407A model would be selected for application with R-448A (LT), R-449A (LR) or R-407F (LF) and would include liquid injection for discharge temperature control

LS - Low temperature R-404A model would be selected for application with R-507 (LP) and would NOT include liquid injection for discharge temperature control

Models numbers with "2" before the L or M temperature range designation or an * at the end have a condenser that meets California Title 24 efficiency requirements. Page 101

Prices, product availability, and specifications are subject to change without notice.



COMMERCIAL LARGE CONDENSING UNIT PRODUCT DESCRIPTION

Version: July 2020

CPB - PARALLEL COMPRESSOR MODELS with BITZER ECOLINE COMPRESSORS (Motor 2)

One refrigeration circuit with two parallel piped compressors and one electrical circuit.

Standard Condenser Model	Compressor Model	95° F Ambient Capacity MBH		Base Unit List Price		Suction filter		Options		Optional Four Year Extended Compressor Warranty	Unit Size	DIMENSIONS (IN)			Ship wt. (lbs)
		@ +25 Evap	@ -20 Evap	230V (K), 460V (M)	575V (P)	Sealed	Replace-able core	Pressure Fan Cycling	Heated & Insulated Receiver			L	W	H	
CPB-0100MS	(2) 4FES-3	87.7	-	\$54,450	\$56,050	\$1,050	\$1,590	\$1,640	\$1,990	\$3,180	F	124.75	45.25	51.5	1,793
CPB-0150MS*	(2) 4EES-4	132.0	-	\$55,560	\$57,160	\$1,050	\$1,590	\$1,640	\$1,990	\$4,200	F	124.75	45.25	51.5	1,884
CPB-0160MS	(2) 4DES-5	138.5	-	\$58,830	\$60,430	\$1,050	\$1,590	\$1,640	\$2,110	\$4,200	G	178.75	45.25	51.5	2,423
CPB-0180MS	(2) 4CES-6	177.1	-	\$61,720	\$63,320	\$1,050	\$1,590	\$1,640	\$2,110	\$5,360	G	178.75	45.25	51.5	2,578
CPB-0200MS	(2) 4TES-9	213.8	-	\$64,800	\$66,400	\$1,050	\$1,590	\$1,640	\$2,170	\$5,360	G	178.75	45.25	51.5	2,705
CPB-0240MS*	(2) 4PES-12	256.2	-	\$64,610	\$66,210	\$1,050	\$1,590	\$1,640	\$2,170	\$6,120	G	178.75	45.25	51.5	2,770
CPB-0300MS	(2) 4NES-14	300.1	-	\$70,270	\$71,870	\$1,050	\$1,590	\$1,640	\$2,240	\$8,110	H	232.75	45.25	51.5	3,160
CPB-0400MS	(2) 4JE-15	338.4	-	\$72,520	\$73,640	\$1,050	\$1,590	\$1,640	\$2,240	\$9,880	H	232.75	45.25	51.5	3,213
CPB-0500MS	(2) 4HE-18	391.4	-	\$77,500	\$79,100	\$1,050	\$1,590	\$1,640	\$2,240	\$11,020	H	232.75	45.25	51.5	3,410
CPB-0600MS	(2) 4GE-23	463.8	-	\$86,470	\$88,250	\$1,050	\$1,590	\$1,030	\$2,330	\$12,590	I	146.00	90.50	51.5	3,833
CPB-0700MS	(2) 6HE-28	597.4	-	\$95,700	\$97,720	\$1,050	\$1,590	\$1,640	\$2,330	\$12,700	J	200.00	90.50	51.5	4,397
CPB-0800MS	(2) 6GE-34	689.4	-	\$106,850	\$109,100	\$1,050	\$1,590	\$1,640	\$3,040	\$14,100	J	200.00	90.50	51.5	5,058
CPB-0300LQ*	(2) 4HE-18	-	121.3	\$70,260	\$71,850	\$1,050	\$1,590	\$1,640	\$2,050	\$8,120	G	178.75	45.25	51.5	2,737
CPB-0440LQ	(2) 4GE-23	-	143.3	\$76,760	\$78,350	\$1,050	\$1,590	\$1,640	\$2,050	\$9,880	H	232.75	45.25	51.5	3,164
CPB-0540LQ	(2) 6HE-28	-	181.8	\$84,570	\$86,330	\$1,050	\$1,590	\$1,640	\$2,240	\$11,020	H	232.75	45.25	51.5	3,512
CPB-0600LQ	(2) 6GE-34	-	213.9	\$91,280	\$93,180	\$1,460	\$2,070	\$1,030	\$2,240	\$12,590	I	146.00	90.50	51.5	3,769
CPB-0300LS*	(2) 4HE-18	-	131.8	\$66,640	\$68,160	\$1,460	\$2,070	\$1,640	\$2,050	\$8,120	G	178.75	45.25	51.5	2,737
CPB-0440LS	(2) 4GE-23	-	155.8	\$73,140	\$74,660	\$1,460	\$2,070	\$1,640	\$2,050	\$9,880	H	232.75	45.25	51.5	3,167
CPB-0540LS	(2) 6HE-28	-	197.6	\$80,960	\$82,650	\$1,460	\$2,070	\$1,640	\$2,240	\$11,020	H	232.75	45.25	51.5	3,453
CPB-0600LS	(2) 6GE-34	-	232.5	\$88,050	\$89,890	\$1,460	\$2,070	\$1,030	\$2,240	\$12,590	I	146.00	90.50	51.5	3,772

Over Sized Condenser Model	Compressor Model	95° F Ambient Capacity MBH		Base Unit List Price		Suction filter		Options		Optional Four Year Extended Compressor Warranty	Unit Size	DIMENSIONS (IN)			Ship wt. (lbs)
		@ +25 Evap	@ -20 Evap	230V (K), 460V (M)	575V (P)	Sealed	Replace-able core	Pressure Fan Cycling	Heated & Insulated Receiver			L	W	H	
CPB-0101MS*	(2) 4FES-3	93	-	\$55,240	\$56,840	\$1,050	\$1,590	\$1,640	\$1,990	\$3,180	F	124.75	45.25	51.5	1,857
CPB-0151MS	(2) 4EES-4	138.5	-	\$56,950	\$58,550	\$1,050	\$1,590	\$1,640	\$2,110	\$4,200	G	178.75	45.25	51.5	2,416
CPB-0161MS	(2) 4DES-5	142.0	-	\$59,780	\$61,380	\$1,050	\$1,590	\$1,640	\$2,110	\$4,200	G	178.75	45.25	51.5	2,485
CPB-0181MS*	(2) 4CES-6	185.8	-	\$63,260	\$64,860	\$1,050	\$1,590	\$1,640	\$2,170	\$5,360	G	178.75	45.25	51.5	2,774
CPB-0201MS	(2) 4TES-9	224.4	-	\$67,280	\$68,880	\$1,050	\$1,590	\$1,640	\$2,170	\$5,360	H	232.75	45.25	51.5	3,122
CPB-0241MS	(2) 4PES-12	263.6	-	\$67,820	\$69,420	\$1,050	\$1,590	\$1,640	\$2,240	\$6,120	H	232.75	45.25	51.5	3,124
CPB-0301MS*	(2) 4NES-14	305.4	-	\$71,080	\$72,680	\$1,050	\$1,590	\$1,640	\$2,240	\$8,110	H	232.75	45.25	51.5	3,322
CPB-0401MS	(2) 4JE-15	354.4	-	\$77,960	\$79,560	\$1,050	\$1,590	\$1,640	\$2,330	\$9,880	I	146.00	90.50	51.5	3,560
CPB-0501MS	(2) 4HE-18	420.2	-	\$79,830	\$81,530	\$1,050	\$1,590	\$1,640	\$2,330	\$11,020	J	200.00	90.50	51.5	4,389
CPB-0601MS	(2) 4GE-23	476.8	-	\$92,510	\$94,450	\$1,050	\$1,590	\$1,640	\$2,430	\$12,590	J	200.00	90.50	51.5	4,448
CPB-0701MS	(2) 6HE-28	624.0	-	\$104,000	\$106,140	\$1,460	\$2,070	\$2,260	\$3,040	\$12,700	K	254.00	90.50	51.5	5,412
CPB-0801MS	(2) 6GE-34	720	-	\$120,180	\$122,670	\$1,460	\$2,070	\$2,260	\$3,040	\$14,100	K	254.00	90.50	51.5	5,816
CPB-0301LQ	(2) 4HE-18	-	129.4	\$72,450	\$74,040	\$1,050	\$1,590	\$1,640	\$2,050	\$8,120	H	232.75	45.25	51.5	3,320
CPB-0441LQ	(2) 4GE-23	-	148.4	\$80,220	\$81,870	\$1,050	\$1,590	\$1,640	\$2,240	\$9,880	H	232.75	45.25	51.5	3,320
CPB-0541LQ	(2) 6HE-28	-	188.4	\$89,370	\$91,220	\$1,050	\$1,590	\$1,030	\$2,330	\$11,020	I	146.00	90.50	51.5	3,823
CPB-0601LQ	(2) 6GE-34	-	222.3	\$101,260	\$103,400	\$1,460	\$2,070	\$1,640	\$2,330	\$12,590	J	200.00	90.50	51.5	4,465
CPB-0301LS	(2) 4HE-18	-	140.7	\$68,830	\$70,350	\$1,050	\$2,150	\$1,640	\$2,050	\$8,120	H	232.75	45.25	51.5	3,320
CPB-0441LS	(2) 4GE-23	-	197.6	\$77,450	\$79,060	\$1,460	\$2,070	\$1,030	\$2,240	\$9,880	H	232.75	45.25	51.5	3,320
CPB-0541LS	(2) 6HE-28	-	204.8	\$85,740	\$87,540	\$1,460	\$2,070	\$1,030	\$2,330	\$11,020	I	146.00	90.50	51.5	3,823
CPB-0601LS	(2) 6GE-34	-	241.6	\$98,040	\$100,110	\$1,460	\$2,070	\$1,640	\$2,330	\$12,590	J	200.00	90.50	51.5	4,465

Over Sized Condenser Model	Compressor Model	95° F Ambient Capacity MBH		Base Unit List Price		Suction filter		Options		Optional Four Year Extended Compressor Warranty	Unit Size	DIMENSIONS (IN)			Ship wt. (lbs)
		@ +25 Evap	@ -20 Evap	230V (K), 460V (M)	575V (P)	Sealed	Replace-able core	Pressure Fan Cycling	Heated & Insulated Receiver			L	W	H	
CPB-0162MS	(2) 4DES-5	144.8	-	\$60,370	\$61,970	\$1,050	\$1,590	\$1,640	\$2,170	\$4,200	G	178.75	45.25	51.5	2,544
CPB-0202MS	(2) 4TES-9	218.1	-	\$64,070	\$65,670	\$1,050	\$1,590	\$1,640	\$2,170	\$5,360	G	178.75	45.25	51.5	2,764
CPB-0402MS	(2) 4JE-15	345.2	-	\$75,800	\$77,400	\$1,050	\$1,590	\$1,640	\$2,240	\$9,880	H	232.75	45.25	51.5	3,301
CPB-0702MS	(2) 6HE-28	609.3	-	\$100,680	\$102,690	\$1,050	\$1,590	\$1,640	\$2,330	\$12,700	J	200.00	90.50	51.5	4,572
CPB-0602LQ	(2) 6GE-34	-	218.2	\$95,580	\$97,480	\$1,460	\$2,070	\$1,030	\$2,240	\$12,590	I	146.00	90.50	51.5	3,899
CPB-0602LS	(2) 6GE-34	-	237.2	\$92,340	\$94,180	\$1,460	\$2,070	\$1,030	\$2,240	\$12,590	I	146.00	90.50	51.5	3,902

ALL PARALLEL UNITS INCLUDE SUCTION ACCUMULATOR AND OIL SEPARATOR.

MS - Medium temperature R-404A models would be selected for R-407A (MQ), R-448A (MT), R-449A (MR), R-407F (MF) or R-507 (MP)

LQ - Low temperature R-407A model would be selected for application with R-448A (LT), R-449A (LR) or R-407F (LF) and would include liquid injection for discharge temperature control

LS - Low temperature R-404A model would be selected for application with R-507 (LP) and would NOT include liquid injection for discharge temperature control

Models numbers with "2" before the L or M temperature range designation or an * at the end have a condenser that meets California Title 24 efficiency requirements.

COMMERCIAL LARGE CONDENSING UNIT PRODUCT DESCRIPTION

Version: July 2020

CPE - PARALLEL COMPRESSOR MODELS with BITZER ECOLINE COMPRESSORS (Motor 1)

One refrigeration circuit with two parallel piped compressors and one electrical circuit.

Standard Condenser Model	Compressor Model	95° F Ambient Capacity MBH		Base Unit List Price		Suction filter		Options		Optional Four Year Extended Compressor Warranty	Unit Size	DIMENSIONS (IN)			Ship wt. (lbs)
		@ +25 Evap	@ -20 Evap	230V (K), 460V (M)	575V (P)	Sealed	Replace-able core	Pressure Fan Cycling	Heated & Insulated Receiver			L	W	H	
CPE-0100MS	(2) 4FES-5	87.7	-	\$54,640	\$56,240	\$1,050	\$1,590	\$1,640	\$1,990	\$3,180	F	124.75	45.25	51.5	1,793
CPE-0150MS*	(2) 4EES-6	132.0	-	\$55,760	\$57,360	\$1,050	\$1,590	\$1,640	\$1,990	\$4,200	F	124.75	45.25	51.5	1,884
CPE-0160MS	(2) 4DES-7	138.5	-	\$59,390	\$60,990	\$1,050	\$1,590	\$1,640	\$2,110	\$4,200	G	178.75	45.25	51.5	2,423
CPE-0180MS	(2) 4CES-9	177.1	-	\$61,940	\$63,540	\$1,050	\$1,590	\$1,640	\$2,110	\$5,360	G	178.75	45.25	51.5	2,578
CPE-0200MS	(2) 4TES-12	213.8	-	\$65,470	\$67,070	\$1,050	\$1,590	\$1,640	\$2,170	\$5,360	G	178.75	45.25	51.5	2,705
CPE-0240MS*	(2) 4PES-15	256.2	-	\$65,290	\$66,890	\$1,050	\$1,590	\$1,640	\$2,170	\$6,120	G	178.75	45.25	51.5	2,770
CPE-0300MS	(2) 4NES-20	300.1	-	\$71,020	\$72,620	\$1,050	\$1,590	\$1,640	\$2,240	\$8,110	H	232.75	45.25	51.5	3,160
CPE-0400MS	(2) 4JE-22	338.4	-	\$73,450	\$75,050	\$1,050	\$1,590	\$1,640	\$2,240	\$9,880	H	232.75	45.25	51.5	3,213
CPE-0500MS	(2) 4HE-25	391.4	-	\$77,760	\$79,360	\$1,050	\$1,590	\$1,640	\$2,240	\$11,020	H	232.75	45.25	51.5	3,410
CPE-0600MS	(2) 4GE-30	463.8	-	\$86,730	\$88,510	\$1,050	\$1,590	\$1,030	\$2,330	\$12,590	I	146.00	90.50	51.5	3,833
CPE-0700MS	(2) 6HE-35	597.4	-	\$95,960	\$97,980	\$1,050	\$1,590	\$1,640	\$2,330	\$12,700	J	200.00	90.50	51.5	4,397
CPE-0800MS	(2) 6GE-40	689.4	-	\$107,110	\$109,360	\$1,050	\$1,590	\$1,640	\$3,040	\$14,100	J	200.00	90.50	51.5	5,058
CPE-0300LQ*	(2) 4HE-25	-	121.3	\$70,730	\$72,320	\$1,050	\$1,590	\$1,640	\$2,050	\$8,120	G	178.75	45.25	51.5	2,737
CPE-0440LQ	(2) 4GE-30	-	143.3	\$77,020	\$78,610	\$1,050	\$1,590	\$1,640	\$2,050	\$9,880	H	232.75	45.25	51.5	3,164
CPE-0540LQ	(2) 6HE-35	-	181.8	\$84,830	\$86,590	\$1,050	\$1,590	\$1,640	\$2,240	\$11,020	H	232.75	45.25	51.5	3,512
CPE-0600LQ	(2) 6GE-40	-	213.9	\$91,540	\$93,440	\$1,460	\$2,070	\$1,030	\$2,240	\$12,590	I	146.00	90.50	51.5	3,769
CPE-0300LS*	(2) 4HE-25	-	131.8	\$67,110	\$68,630	\$1,460	\$2,070	\$1,640	\$2,050	\$8,120	G	178.75	45.25	51.5	2,737
CPE-0440LS	(2) 4GE-30	-	155.8	\$73,400	\$74,920	\$1,460	\$2,070	\$1,640	\$2,050	\$9,880	H	232.75	45.25	51.5	3,167
CPE-0540LS	(2) 6HE-35	-	197.6	\$81,220	\$82,910	\$1,460	\$2,070	\$1,640	\$2,240	\$11,020	H	232.75	45.25	51.5	3,453
CPE-0600LS	(2) 6GE-40	-	232.5	\$88,310	\$90,150	\$1,460	\$2,070	\$1,030	\$2,240	\$12,590	I	146.00	90.50	51.5	3,772

Over Sized Condenser Model	Compressor Model	95° F Ambient Capacity MBH		Base Unit List Price		Suction filter		Options		Optional Four Year Extended Compressor Warranty	Unit Size	DIMENSIONS (IN)			Ship wt. (lbs)
		@ +25 Evap	@ -20 Evap	230V (K), 460V (M)	575V (P)	Sealed	Replace-able core	Pressure Fan Cycling	Heated & Insulated Receiver			L	W	H	
CPE-0101MS*	(2) 4FES-5	93	-	\$55,430	\$57,030	\$1,050	\$1,590	\$1,640	\$1,990	\$3,180	F	124.75	45.25	51.5	1,857
CPE-0151MS	(2) 4EES-6	138.5	-	\$57,150	\$58,750	\$1,050	\$1,590	\$1,640	\$2,110	\$4,200	G	178.75	45.25	51.5	2,416
CPE-0161MS	(2) 4DES-7	144.8	-	\$60,340	\$61,940	\$1,050	\$1,590	\$1,640	\$2,110	\$4,200	G	178.75	45.25	51.5	2,485
CPE-0181MS*	(2) 4CES-9	185.8	-	\$63,480	\$65,080	\$1,050	\$1,590	\$1,640	\$2,170	\$5,360	G	178.75	45.25	51.5	2,774
CPE-0201MS	(2) 4TES-12	224.4	-	\$67,950	\$69,550	\$1,050	\$1,590	\$1,640	\$2,170	\$5,360	H	232.75	45.25	51.5	3,122
CPE-0241MS	(2) 4PES-15	263.6	-	\$68,500	\$70,100	\$1,050	\$1,590	\$1,640	\$2,240	\$6,120	H	232.75	45.25	51.5	3,124
CPE-0301MS*	(2) 4NES-20	305.4	-	\$71,830	\$73,430	\$1,050	\$1,590	\$1,640	\$2,240	\$8,110	H	232.75	45.25	51.5	3,322
CPE-0401MS	(2) 4JE-22	354.4	-	\$78,790	\$80,390	\$1,050	\$1,590	\$1,640	\$2,330	\$9,880	I	146.00	90.50	51.5	3,560
CPE-0501MS	(2) 4HE-25	420.2	-	\$80,090	\$81,790	\$1,050	\$1,590	\$1,640	\$2,330	\$11,020	J	200.00	90.50	51.5	4,389
CPE-0601MS	(2) 4GE-30	476.8	-	\$92,770	\$94,710	\$1,050	\$1,590	\$1,640	\$2,430	\$12,590	J	200.00	90.50	51.5	4,448
CPE-0701MS	(2) 6HE-35	624.0	-	\$104,260	\$106,400	\$1,460	\$2,070	\$2,260	\$3,040	\$12,700	K	254.00	90.50	51.5	5,412
CPE-0801MS	(2) 6GE-40	720	-	\$120,440	\$122,930	\$1,460	\$2,070	\$2,260	\$3,040	\$14,100	K	254.00	90.50	51.5	5,816
CPE-0301LQ	(2) 4HE-25	-	129.4	\$72,920	\$74,510	\$1,050	\$1,590	\$1,640	\$2,050	\$8,120	H	232.75	45.25	51.5	3,320
CPE-0441LQ	(2) 4GE-30	-	148.4	\$80,480	\$82,130	\$1,050	\$1,590	\$1,640	\$2,240	\$9,880	H	232.75	45.25	51.5	3,320
CPE-0541LQ	(2) 6HE-35	-	188.4	\$89,630	\$91,480	\$1,050	\$1,590	\$1,030	\$2,330	\$11,020	I	146.00	90.50	51.5	3,823
CPE-0601LQ	(2) 6GE-40	-	222.3	\$101,520	\$103,660	\$1,460	\$2,070	\$1,640	\$2,330	\$12,590	J	200.00	90.50	51.5	4,465
CPE-0301LS	(2) 4HE-25	-	140.7	\$69,300	\$70,820	\$1,050	\$2,150	\$1,640	\$2,050	\$8,120	H	232.75	45.25	51.5	3,320
CPE-0441LS	(2) 4GE-30	-	161.3	\$77,710	\$79,320	\$1,460	\$2,070	\$1,030	\$2,240	\$9,880	I	146.00	90.50	51.5	3,509
CPE-0541LS	(2) 6HE-35	-	204.8	\$86,000	\$87,800	\$1,460	\$2,070	\$1,030	\$2,330	\$11,020	I	146.00	90.50	51.5	3,872
CPE-0601LS	(2) 6GE-40	-	241.6	\$98,300	\$100,370	\$1,460	\$2,070	\$1,640	\$2,330	\$12,590	J	200.00	90.50	51.5	4,566

Over Sized Condenser Model	Compressor Model	95° F Ambient Capacity MBH		Base Unit List Price		Suction filter		Options		Optional Four Year Extended Compressor Warranty	Unit Size	DIMENSIONS (IN)			Ship wt. (lbs)
		@ +25 Evap	@ -20 Evap	230V (K), 460V (M)	575V (P)	Sealed	Replace-able core	Pressure Fan Cycling	Heated & Insulated Receiver			L	W	H	
CPE-0162MS	(2) 4DES-7	144.8	-	\$60,930	\$62,530	\$1,050	\$1,590	\$1,640	\$2,170	\$4,200	G	178.75	45.25	51.5	2,544
CPE-0202MS	(2) 4TES-12	218.1	-	\$64,740	\$66,340	\$1,050	\$1,590	\$1,640	\$2,170	\$5,360	G	178.75	45.25	51.5	2,764
CPE-0402MS	(2) 4JE-22	345.2	-	\$76,630	\$78,230	\$1,050	\$1,590	\$1,640	\$2,240	\$9,880	H	232.75	45.25	51.5	3,301
CPE-0702MS	(2) 6HE-35	609.3	-	\$100,940	\$102,950	\$1,050	\$1,590	\$1,640	\$2,330	\$12,700	J	200.00	90.50	51.5	4,572
CPE-0602LQ	(2) 6GE-40	-	218.2	\$95,840	\$97,740	\$1,460	\$2,070	\$1,030	\$2,240	\$12,590	I	146.00	90.50	51.5	3,899
CPE-0602LS	(2) 6GE-40	-	237.2	\$92,600	\$94,440	\$1,460	\$2,070	\$1,030	\$2,240	\$12,590	I	146.00	90.50	51.5	3,902

ALL PARALLEL UNITS INCLUDE SUCTION ACCUMULATOR AND OIL SEPARATOR.

MS - Medium temperature R-404A models would be selected for R-407A (MQ), R-448A (MT), R-449A (MR), R-407F (MF) or R-507 (MP)

LQ - Low temperature R-407A model would be selected for application with R-448A (LT), R-449A (LR) or R-407F (LF) and would include liquid injection for discharge temperature control

LS - Low temperature R-404A model would be selected for application with R-507 (LP) and would NOT include liquid injection for discharge temperature control

Models numbers with "2" before the L or M temperature range designation or an * at the end have a condenser that meets California Title 24 efficiency requirements.

Prices, product availability, and specifications are subject to change without notice.

COMMERCIAL LARGE CONDENSING UNIT PRODUCT DESCRIPTION

Version: **July 2020**

LARGE CONDENSING UNIT OPTIONS

Electrical Options: Mounted Defrost Kits

	List Price*
A-1 AIR DEFROST KIT INCLUDES DEFROST TIME CLOCK ONLY	\$480
A-2 AIR DEFROST KIT INCLUDES DEFROST TIMER; FUSED FAN CONTACTOR	\$820
E-1 ELECTRIC DEFROST KIT INCLUDES ELECTRIC DEFROST TIME CLOCK ONLY ; FOR USE WITH 230/1 FAN AND HEATERS ONLY	\$480
E-2 ELECTRIC DEFROST KIT INCLUDES ELECTRIC DEFROST TIME CLOCK FUSED HEATER CONTACTOR UP TO 48 AMP 230/1 PHASE MOTORS ONLY	\$980
E-3 DEFROST KIT INCLUDES ELECTRIC DEFROST TIME CLOCK FUSED HEATER & CONTACTOR UP TO 48 AMP FUSED FAN CONTACTOR UP TO 12 AMP	\$1,450
E-4 DEFROST KIT INCLUDES ELECTRIC DEFROST TIME CLOCK FUSED HEATER & CONTACTORS (2)48A MAX EACH FUSED FAN CONTACTOR UP TO 48 AMP	\$1,990
E-5 DEFROST KIT INCLUDES ELECTRIC DEFROST TIME CLOCK FUSED HEATER & CONTACTORS (3)48A MAX EACH FUSED FAN CONTACTOR UP TO 48 AMP	\$2,520

Note: For Dual (CD) units, add option per circuit (2x).

Additional Options

	List Price*
115 VOLT CONTROL CIRCUIT	\$530
PHASE LOSS MONITOR	\$1,110
ANTI-SHORT CYCLE TIME DELAY RELAY	\$790
SAFE START TIME DELAY (bypass low pressure control)	\$790
CURRENT SENSING RELAY	\$790
OIL RESERVOIR (for use with oil separator)	\$2,570
VFD POWER DISTRIBUTION BLOCK (Required with VFD Motors)	\$620
COMPRESSOR CYLINDER UNLOADING (PER UNLOADER) 4D - 1 @ 50% ; 6D - 2 @ 67% / 33% ; 8D - 2 @ 75% / 50%	\$1,020
GAUGE KIT (HIGH / LOW / OIL PRESSURE)	\$1,610
**LIQUID LINE SOLENOID VALVE INSTALLED (5 - 22 H.P.)	\$1,020
**LIQUID LINE SOLENOID VALVE INSTALLED (22 - 60 H.P.)	\$1,340
HOT GAS BYPASS to EVAPORATOR (Capacity Control)	\$1,780
HOT GAS BYPASS to SUCTION LINE (Capacity Control)	\$2,960
HEAT RECLAIM VALVE	C/F
DISCHARGE LINE CHECK VALVE	C/F
ISOLATION BALL VALVES	C/F

** It is recommended that liquid line solenoid valves be installed at the evaporator, except in instances of very short line runs.

Non - Fused Disconnect Mounted	List Price	Fused Disconnect (Ship Loose)**	List Price 230 V (K)	List Price 460 V (M)
60 AMP	\$1,470	60 AMP	\$1,390	\$1,390
100 AMP	\$1,790	100 AMP	\$2,550	\$2,550
175 AMP	\$2,660	-	-	-
200 AMP	\$2,830	200 AMP	\$3,130	\$3,130
400 AMP	\$5,680	400 AMP	\$7,580	\$7,580
600 + AMP	C/F	600 + AMP	C/F	C/F

* **Note:** For Dual (CD) units, there is a single point power connection.
Add amperage for entire unit (include evaporator and / or heater amps),
Select a single disconnect for amperage required.

** Fused Disconnects ship LESS FUSES

COND FANS	Condenser Clean Out Doors
1x1	\$150
1x2	\$300
1x3	\$450
1x4	\$600
1x5	\$750
1x6	\$900
2x2	\$300
2x3	\$600
2x4	\$900
2x5	\$1,200
2x6	\$1,500

** For number of fans, refer to technical brochure

C/F = Contact APPLICATION ENGINEERING For Special Requests.

For 230 V evaporators on 460 V condensing units, consult Application Eng.

Prices, product availability, and specifications
are subject to change without notice.



COMMERCIAL LARGE CONDENSING UNIT PRODUCT DESCRIPTION

Version: **July 2020**

LARGE CONDENSING UNIT OPTIONS

Coil Coating and Special Fin Option Pricing

UNIT Model	ElectroFin Coated Coil	Polyester Fin Coating *	Copper Fin	UNIT Model	ElectroFin Coated Coil	Polyester Fin Coating *	Copper Fin	UNIT Model	ElectroFin Coated Coil	Polyester Fin Coating *	Copper Fin
CS*0100M*	\$1,190	\$990	\$2,600	CP*-0100M*	\$1,190	\$990	\$2,600	CD*0100M*	\$1,090	\$900	\$2,400
CS*0150M*	\$1,550	\$1,290	\$3,440	CP*-0150M*	\$1,220	\$1,020	\$2,690	CD*0150M*	\$1,220	\$1,020	\$2,690
CS*0200M*	\$1,550	\$1,290	\$3,440	CP*-0160M*	\$1,550	\$1,290	\$3,440	CD*0160M*	\$1,550	\$1,290	\$3,440
CS*0250M*	\$1,670	\$1,390	\$3,690	CP*-0180M*	\$1,550	\$1,290	\$3,440	CD*0180M*	\$1,550	\$1,290	\$3,440
CS*0300M*	\$1,730	\$1,450	\$3,840	CP*-0200M*	\$1,670	\$1,390	\$3,690	CD*0200M*	\$1,670	\$1,390	\$3,690
CS*0350M*	\$2,480	\$2,070	\$5,500	CP*-0240M*	\$2,130	\$1,780	\$4,700	CD*0240M*	\$2,130	\$1,780	\$4,700
CS*0400M*	\$2,480	\$2,070	\$5,500	CP*-0300M*	\$2,480	\$2,070	\$5,500	CD*0300M*	\$2,480	\$2,070	\$5,500
CS*0500M*	\$3,330	\$2,780	\$7,330	CP*-0400M*	\$2,480	\$2,070	\$5,500	CD*0400M*	\$2,480	\$2,070	\$5,500
				CP*-0500M*	\$3,010	\$2,510	\$6,680	CD*0500M*	\$3,010	\$2,510	\$6,680
CS*0101M*	\$1,550	\$1,290	\$3,440	CP*0600M*	\$3,330	\$2,780	\$7,330	CD*0600M*	\$3,330	\$2,780	\$7,330
CS*0151M*	\$1,670	\$1,390	\$3,690	CP*0700M*	\$4,660	\$3,880	\$10,220	CD*0700M*	\$4,950	\$4,130	\$10,940
CS*0201M*	\$1,670	\$1,390	\$3,690	CP*0800M*	\$5,140	\$4,280	\$11,320	CD*0800M*	\$5,140	\$4,280	\$11,320
CS*0251M*	\$2,480	\$2,070	\$5,500								
CS*0301M*	\$2,480	\$2,070	\$5,500	CP*-0101M*	\$1,220	\$1,020	\$2,690	CD*0101M*	\$1,220	\$1,020	\$2,690
CS*0351M*	\$3,330	\$2,780	\$7,330	CP*-0151M*	\$1,550	\$1,290	\$3,440	CD*0151M*	\$1,550	\$1,290	\$3,440
CS*0401M*	\$4,270	\$3,560	\$9,340	CP*-0161M*	\$1,670	\$1,390	\$3,690	CD*0161M*	\$1,670	\$1,390	\$3,690
CS*0501M*	\$4,950	\$4,130	\$10,940	CP*-0181M*	\$2,130	\$1,780	\$4,700	CD*0181M*	\$2,130	\$1,780	\$4,700
				CP*-0201M*	\$2,480	\$2,070	\$5,500	CD*0201M*	\$2,480	\$2,070	\$300
CS*0102M*	\$1,220	\$1,020	\$2,690	CP*-0241M*	\$2,480	\$2,070	\$5,500	CD*0241M*	\$2,480	\$2,070	\$5,500
CS*0152M*	\$2,130	\$1,780	\$4,700	CP*-0301M*	\$3,010	\$2,510	\$6,680	CD*0301M*	\$3,010	\$2,510	\$6,680
CS*0202M*	\$2,130	\$1,780	\$4,700	CP*-0401M*	\$3,330	\$2,780	\$7,330	CD*0401M*	\$3,330	\$2,780	\$7,330
CS*0252M*	\$2,130	\$1,780	\$4,700	CP*0501M*	\$4,950	\$4,130	\$10,940	CD*0501M*	\$4,660	\$3,880	\$10,220
CS*0302M*	\$2,130	\$1,780	\$4,700	CP*0601M*	\$4,950	\$4,130	\$10,940	CD*0601M*	\$4,950	\$4,130	\$10,940
CS*0352M*	\$3,010	\$2,510	\$6,680	CP*0701M*	\$6,560	\$5,470	\$14,480	CD*0701M*	\$6,020	\$5,010	\$13,260
CS*0502M*	\$4,270	\$3,560	\$9,340	CP*0801M*	\$7,900	\$6,580	\$17,420	CD*0801M*	\$7,900	\$6,580	\$17,420
CS*0150L*	\$1,220	\$1,020	\$2,690	CP*-0162M*	\$2,130	\$1,780	\$4,700	CD*-0162M*	\$2,130	\$1,780	\$4,700
CS*0220L*	\$1,550	\$1,290	\$3,440	CP*-0202M*	\$2,130	\$1,780	\$4,700	CD*-0202M*	\$2,130	\$1,780	\$4,700
CS*0270L*	\$1,670	\$1,390	\$3,690	CP*-0402M*	\$3,010	\$2,510	\$6,680	CD*-0402M*	\$3,010	\$2,510	\$6,680
CS*0300L*	\$1,730	\$1,450	\$3,840	CP*-0702M*	\$5,140	\$4,280	\$11,320	CD*-0702M*	\$5,140	\$4,280	\$11,320
CS*0151L*	\$1,550	\$1,290	\$3,440								
CS*0221L*	\$1,670	\$1,390	\$3,690	CP*0300L*	\$2,130	\$1,780	\$4,700	CD*0300L*	\$2,130	\$1,780	\$4,700
CS*0271L*	\$2,320	\$1,930	\$5,160	CP*0440L*	\$2,570	\$2,140	\$5,680	CD*0440L*	\$2,480	\$2,070	\$5,500
CS*0301L*	\$2,480	\$2,070	\$5,500	CP*0540L*	\$2,480	\$2,070	\$5,500	CD*0540L*	\$3,010	\$2,510	\$6,680
CS*0222L*	\$2,130	\$1,780	\$4,700	CP*0600L*	\$3,330	\$2,780	\$7,330	CD*0600L*	\$3,330	\$2,780	\$7,330
CS*0272L*	\$2,130	\$1,780	\$4,700	CP*0301L*	\$2,480	\$2,070	\$5,500	CD*0301L*	\$2,480	\$2,070	\$5,500
CS*0302L*	\$2,130	\$1,780	\$4,700	CP*0441L*	\$3,330	\$2,780	\$7,330	CD*0441L*	\$3,010	\$2,510	\$6,680
				CP*0541L*	\$4,270	\$3,560	\$9,340	CD*0541L*	\$4,270	\$3,560	\$9,340
				CP*0601L*	\$4,950	\$4,130	\$10,940	CD*0601L*	\$4,950	\$4,130	\$10,940
				CP*0602L*	\$4,270	\$3,560	\$9,340	CD*0602L*	\$4,270	\$3,560	\$9,340

* Polyester fin coating is a vinyl coated fin material.

C/F = Contact APPLICATION ENGINEERING For Special Requests.

Prices, product availability, and specifications are subject to change without notice.



COMMERCIAL LARGE CONDENSING UNIT PRODUCT DESCRIPTION

Version: **July 2020**

LARGE CONDENSING UNIT RECEIVER SIZING

Receiver Volume = Flooding Charge + Liquid Line + Evaporator Charge

The receiver pump down capacity (volume) should be compared to the required system charge whenever any of the following occurs:

- Multiple evaporators are matched to one compressor
- Any Industrial evaporator is used (tubing larger than 1/2" OD)
- Liquid line is known to exceed 100 feet in length

WINTER FLOODING CHARGE

Winter flooding charge is defined as the additional refrigerant that must be added to the system to flood the condenser for winter operation. The charge can be obtained from Tables 4a - 4c.

Winter Flooding Charge = Winter Charge - Summer Charge

LIQUID LINE CHARGE

The weight of the refrigerant in a liquid line per 100 feet is shown in Table 1.

TABLE 1	Liquid Line Refrigerant Weight During Operation (Pounds per 100 lineal feet of type "L" tubing)					
	1/2" OD	5/8" OD	7/8" OD	1-1/8" OD	1-3/8" OD	1-5/8" OD
R-404A/507	6.4	10.3	21.2	36.1	55.0	78.0
R-407A/407F	7.0	11.3	23.2	39.5	60.2	85.4
R-448A/449A	6.7	10.8	22.2	37.9	57.7	81.8
R-22	7.4	11.8	24.4	41.6	63.5	90.0

EVAPORATOR CHARGE

The evaporator liquid charge is estimated to be between 15% and 30% of the coil volume at the density of the refrigerant at the saturated suction temperature of the coil. See Table 2 for densities at varying temperatures.

Evaporator Liquid Charge = Evaporator Coil Volume x 0.30 x Density

TABLE 2	Density Table (lb/cu ft)			
	Liquid Temperature (°F)			
Refrigerant	-20° F	0° F	20° F	90° F
R-404A/507	77.3	74.9	72.3	60.4
R-407A/407F	84.0	81.6	79.1	69.3
R-448A/449A	80.6	78.3	75.9	65.9
R-22	85.8	83.6	81.4	72.5

Prices, product availability, and specifications are subject to change without notice.



COMMERCIAL LARGE CONDENSING UNIT PRODUCT DESCRIPTION

Version: **July 2020**

LARGE CONDENSING UNIT RECEIVER SIZE *continued*

RECEIVER SIZE and PRICING

If you require a larger receiver, see Table 3a for receiver capacity chart and pricing.

EXAMPLE:

Verify the receiver sizing for the following matched system:

- (1) CS*-0300M4M Condensing Unit (10-3/4" x 48" Receiver, 114 lbs R-404A @ 80%)
- (2) SM36A1498 (2.24 cu ft or 49.38 lbs R-404A each)

Step 1: Determine the Winter Flooding Charge

From Table 4a, or CS O&I Manual, calculate the difference in operating charge between -20° F and 70° F (adjust temperatures per the location):

$$\text{Winter Flooding Charge} = 86.1 - 46.9 = 39.2 \text{ lbs R-404A}$$

Step 2: Determine the Liquid Line Charge

If the actual length is not known, use the best judgment in determining length of liquid line. The liquid line should be sized based on line sizing charts for the application, not just the liquid line connection on the condensing unit. For this example 100 feet of 7/8" OD tubing is assumed:

$$\text{From Table 1, } 21.2 \text{ lbs of R-404A}$$

Step 3: Determine the Evaporator Charge

Evaporator coil volume is 2.24 cu ft. or 49.38 lbs R-404A . (Multiply cu ft by percent of coil assumed to be liquid and the density (Table 2) of the liquid refrigerant @ 90° F)

$$\text{Evaporator Liquid Charge} = 49.38 \text{ lbs} \times 2 \text{ coils} = 98.76 \text{ lbs R-404A}$$

Step 4: Calculate the Total Charge Required for Receiver Volume

$$\text{Required Charge} = 39.2 + 21.2 + 98.76 = 159.2 \text{ lbs R-404A}$$

Receiver volume is 114 lbs. Therefore the standard receiver is NOT adequate for full pump down. The correct receiver for the application from Table 3 is the 10-3/4" x 72" vessel.

**Larger Receiver Price Adder = "E" Receiver List Price \$3,120 - "D" Receiver List Price \$1,850.
For an Option Price, add of \$1,270.**

TABLE 3a

Receiver Letter Desig.	Recr Size	Receiver Capacity 80% Full				List Price	Htd & Ins List Price
		R-404A/507	R-407A/F	R-448A/449A	R-22		
A	8-5/8 x 28	43	47	45	48	\$1,410	\$1,770
B	8-5/8 x 48	75	82	79	84	\$1,650	\$1,990
C	8-5/8 x 60	94	103	99	106	\$1,800	\$2,110
D	10-3/4 x 48	114	125	120	128	\$1,850	\$2,170
E	10-3/4 x 72	174	190	183	195	\$3,120	\$2,240
F	10-3/4 x 96	233	255	244	262	\$3,470	\$2,330
G	10-3/4 x 108	263	288	276	295	\$4,020	\$2,430
H	10-3/4 x 144	347	380	364	390	\$4,720	\$3,040

The list price add for an OVERSIZED RECEIVER is obtained by subtracting the list price of the original receiver from the list price of the larger receiver.

The list price add to HEAT & INSULATE a receiver is the full price shown next to the corresponding receiver size.

SEE TABLE 3b FOR MAXIMUM RECEIVER SIZE PER CONDENSER LENGTH.

TABLE 3b

*Condenser Drawing	Maximum Length of
CS-11	48"
CS-12	108"
CS-13	144"
CS-22	108"
CP-23	144"
CD-11	48"
CD-12	108"
CD-13	144"
CD-24	144"

* See Unit brochure.

Refer to condensing unit drawing letter shown on the right-hand side of pages 64 to 66 in technical bulletin LACC_005_030520.

**COMMERCIAL LARGE CONDENSING UNIT
PRODUCT DESCRIPTION**

Version: **July 2020**

LARGE CONDENSING UNIT RECEIVER SIZE (continued)

TABLE 4a - CS* Unit Refrigerant Charge

Model	Refrigerant	REFRIGERANT CHARGE - LBS					
		Above 70° F	50° F	30° F	10° F	0° F	Below -20° F
CS*0100MS	R-22	29.1	39.8	43.6	45.9	46.8	48.4
CS*0150MS	R-22	31.6	37.3	44.8	49.0	50.6	53.1
CS*0200MS	R-22	31.6	37.3	44.8	49.0	50.6	53.1
CS*0250MS	R-22	42.4	50.7	61.9	68.2	70.5	74.2
CS*0300MS	R-22	53.2	64.2	79.0	87.4	90.4	95.3
CS*0350MS	R-22	55.7	58.6	71.9	84.0	88.5	95.4
CS*0400MS	R-22	72.5	76.0	89.6	101.9	106.6	113.7
CS*0500MS	R-22	80.6	97.0	119.3	131.8	136.4	143.7
CS*0600MS	R-22	97.1	101.8	120.0	136.4	142.6	152.2
CS*0101MS	R-22	31.6	42.4	48.3	51.6	53.0	55.5
CS*0151MS	R-22	42.4	58.4	67.1	72.1	74.1	77.8
CS*0201MS	R-22	42.4	58.4	67.1	72.1	74.1	77.8
CS*0251MS	R-22	42.3	48.0	60.6	67.1	69.5	73.4
CS*0301MS	R-22	55.7	63.9	82.7	92.4	95.9	101.7
CS*0351MS	R-22	80.4	91.5	116.6	129.7	134.5	142.2
CS*0401MS	R-22	91.2	132.9	155.9	168.7	173.8	183.5
CS*0501MS	R-22	112.9	129.4	166.9	186.4	193.5	205.0
CS*0601MS	R-22	137.0	158.4	208.2	234.0	243.3	258.4
CS*0150LQ	R-22	31.8	52.0	55.0	56.9	57.7	59.2
CS*0220LQ	R-22	31.6	47.5	51.8	54.1	55.2	57.1
CS*0270LQ	R-22	36.9	60.3	66.6	70.0	71.5	74.1
CS*0300LQ	R-22	36.9	60.3	66.6	70.0	71.5	74.1
CS*0151LQ	R-22	36.9	60.3	66.6	70.0	71.5	74.1
CS*0221LQ	R-22	36.9	60.3	66.6	70.0	71.5	74.1
CS*0271LQ	R-22	36.8	53.8	62.1	66.5	68.4	71.4
CS*0301LQ	R-22	50.2	75.6	87.9	94.4	97.3	101.6
CS*0150MS	R-404A	27.9	33.4	40.2	44.2	45.7	48.1
CS*0200MS	R-404A	27.9	33.4	40.2	44.2	45.7	48.1
CS*0250MS	R-404A	37.4	45.4	55.6	61.5	63.6	67.1
CS*0300MS	R-404A	46.9	57.4	70.9	78.7	81.6	86.1
CS*0350MS	R-404A	42.2	45.0	53.3	60.9	63.8	68.2
CS*0400MS	R-404A	70.8	75.7	91.9	106.8	112.5	121.0
CS*0151MS	R-404A	37.4	52.1	60.2	64.9	66.8	70.3
CS*0201MS	R-404A	37.4	52.1	60.2	64.9	66.8	70.3
CS*0251MS	R-404A	49.0	57.1	74.1	83.2	86.5	91.8
CS*0301MS	R-404A	63.9	72.9	90.2	99.6	103.1	108.7
CS*0351MS	R-404A	71.0	100.2	116.3	125.7	129.4	136.4
CS*0401MS	R-404A	95.1	134.1	155.6	168.1	173.1	182.4
CS*0150LS	R-404A	29.5	43.7	47.5	50.0	50.8	52.5
CS*0220LS	R-404A	29.3	37.9	43.3	46.6	47.9	50.3
CS*0270LS	R-404A	39.5	52.1	60.2	64.9	66.8	70.3
CS*0300LS	R-404A	44.8	61.2	71.8	77.9	80.4	84.9
CS*0151LS	R-404A	29.3	42.4	46.4	48.8	49.8	51.6
CS*0221LS	R-404A	39.5	58.9	64.8	68.3	69.8	72.4
CS*0271LS	R-404A	39.4	53.1	60.9	65.2	67.1	70.0
CS*0301LS	R-404A	52.2	72.4	83.9	90.2	93.0	97.1

Prices, product availability, and specifications are subject to change without notice.



**COMMERCIAL LARGE CONDENSING UNIT
PRODUCT DESCRIPTION**

Version: **July 2020**

LARGE CONDENSING UNIT RECEIVER SIZE (continued)

TABLE 4b - CD* Unit Refrigerant Charge *

Model	Refrigerant	REFRIGERANT CHARGE - LBS					
		Above 70° F	50° F	30° F	10° F	0° F	Below -20° F
CD*0100MS	R-22	14.7	18.5	19.8	20.7	21.0	21.6
CD*0150MS	R-22	17.4	24.5	27.0	28.5	29.0	30.0
CD*0160MS	R-22	17.3	20.2	24.0	26.1	26.9	28.2
CD*0180MS	R-22	17.3	20.2	24.0	26.1	26.9	28.2
CD*0200MS	R-22	29.0	33.4	39.1	42.4	43.6	45.6
CD*0240MS	R-22	31.6	37.3	44.8	49.0	50.6	53.1
CD*0300MS	R-22	32.9	34.5	41.2	47.3	49.6	53.2
CD*0400MS	R-22	32.9	34.5	41.2	47.3	49.6	53.2
CD*0500MS	R-22	42.3	44.4	53.4	61.5	64.6	69.2
CD*0600MS	R-22	53.2	64.2	79.0	87.4	90.4	95.3
CD*0700MS	R-22	55.7	58.6	71.9	84.0	88.5	95.4
CD*0800MS	R-22	80.4	84.5	102.3	118.5	124.6	133.8
CD*1000MS	R-22	80.3	83.9	89.7	109.1	117.5	126.4
CD*1200MS	R-22	104.8	108.7	110.6	130.4	144.0	155.1
CD*0101MS	R-22	17.4	26.0	28.0	29.3	29.8	30.7
CD*0151MS	R-22	17.3	22.7	25.7	27.4	28.1	29.4
CD*0161MS	R-22	20.0	27.9	32.3	34.7	35.7	37.5
CD*0181MS	R-22	31.6	42.4	48.3	51.6	53.0	55.5
CD*0201MS	R-22	32.9	37.1	46.6	51.6	53.4	56.3
CD*0241MS	R-22	32.9	37.1	46.6	51.6	53.4	56.3
CD*0301MS	R-22	42.3	48.0	60.6	67.1	69.5	73.4
CD*0401MS	R-22	42.4	58.4	67.1	72.1	74.1	77.8
CD*0501MS	R-22	42.3	48.0	60.6	67.1	69.5	73.4
CD*0601MS	R-22	55.7	63.9	82.7	92.4	95.9	101.7
CD*0701MS	R-22	80.4	91.5	116.6	129.7	134.5	142.2
CD*0801MS	R-22	90.8	95.9	126.1	145.9	152.3	164.1
CD*1001MS	R-22	117.9	122.3	147.4	176.9	186.1	203.1
CD*1201MS	R-22	136.6	141.6	157.9	198.1	209.5	231.5
CD*0440LQ	R-22	23.9	36.5	42.7	45.9	47.3	49.4
CD*0540LQ	R-22	27.8	44.5	52.6	56.9	58.7	61.5
CD*0600LQ	R-22	36.9	60.3	66.6	70.0	71.5	74.1
CD*0441LQ	R-22	27.8	44.5	52.6	56.9	58.7	61.5
CD*0541LQ	R-22	33.2	63.8	71.9	76.1	78.0	81.2
CD*0601LQ	R-22	44.7	69.9	82.1	88.5	91.3	95.5
CD*0400MS	R-404A	29.0	30.9	37.1	42.7	44.9	48.1
CD*0500MS	R-404A	37.3	39.8	48.0	55.5	58.4	62.7
CD*0600MS	R-404A	46.9	57.4	70.9	78.7	81.6	86.1
CD*0700MS	R-404A	42.2	45.0	53.3	60.9	63.8	68.2
CD*0800MS	R-404A	70.8	75.7	91.9	106.8	112.5	121.0
CD*0401MS	R-404A	37.4	52.1	60.2	64.9	66.8	70.3
CD*0501MS	R-404A	49.0	51.7	74.1	83.2	86.5	91.8
CD*0601MS	R-404A	63.9	72.9	90.2	99.6	103.1	108.7
CD*0701MS	R-404A	70.7	75.8	96.5	110.4	115.0	123.4
CD*0801MS	R-404A	94.7	101.5	129.2	147.7	153.9	165.0
CD*0440LS	R-404A	30.5	33.3	41.9	46.5	48.2	51.0
CD*0540LS	R-404A	39.4	42.9	54.4	60.5	62.8	66.4
CD*0600LS	R-404A	39.5	52.1	60.2	64.9	66.8	70.3
CD*0441LS	R-404A	39.5	58.9	64.8	68.3	69.8	72.4
CD*0541LS	R-404A	44.8	70.2	78.0	82.4	84.3	87.6
CD*0601LS	R-404A	52.2	72.4	83.9	90.2	93.0	97.1

* All units have two refrigerant circuits. Refrigerant charge shown is per circuit.



**COMMERCIAL LARGE CONDENSING UNIT
PRODUCT DESCRIPTION**

Version: **July 2020**

LARGE CONDENSING UNIT RECEIVER SIZE (continued)

TABLE 4c - CP* Unit Refrigerant Charge

Model	Refrigerant	REFRIGERANT CHARGE - LBS					
		Above 70° F	50° F	30° F	10° F	0° F	Below -20° F
CP*0500MS	R-22	80.4	84.5	102.3	118.5	124.6	133.8
CP*0600MS	R-22	107.9	129.9	159.7	176.3	182.4	192.2
CP*0700MS	R-22	112.9	118.8	145.4	169.5	178.6	192.4
CP*0800MS	R-22	160.7	168.9	204.6	236.9	249.1	267.7
CP*1000MS	R-22	160.5	167.8	179.5	218.3	235.0	252.8
CP*1200MS	R-22	144.1	149.5	152.1	190.6	217.3	238.3
CP*0501MS	R-22	80.4	91.5	116.6	129.7	134.5	142.2
CP*0601MS	R-22	112.9	129.4	166.9	186.4	193.5	205.0
CP*0701MS	R-22	137.0	158.4	208.2	234.0	243.3	258.4
CP*0801MS	R-22	181.5	191.9	252.3	291.7	304.7	328.2
CP*1001MS	R-22	170.3	176.7	225.6	283.6	301.5	334.3
CP*1201MS	R-22	199.4	206.8	237.9	317.1	339.3	382.1
CP*0440LQ	R-22	44.7	69.9	82.1	88.5	91.3	95.5
CP*0540LQ	R-22	52.6	85.9	102.1	110.5	114.2	119.7
CP*0600LQ	R-22	58.3	104.5	116.8	123.3	126.2	131.2
CP*0441LQ	R-22	52.6	85.9	102.1	110.5	114.2	119.7
CP*0541LQ	R-22	63.4	124.5	140.6	149.1	152.8	159.1
CP*0601LQ	R-22	73.9	123.6	147.9	160.4	165.9	174.1
CP*0500MS	R-404A	70.8	75.7	91.9	106.8	112.5	121.0
CP*0600MS	R-404A	95.1	116.1	143.2	158.8	164.6	173.7
CP*0700MS	R-404A	85.7	91.4	108.0	123.2	129.1	137.9
CP*0800MS	R-404A	141.6	151.4	183.9	213.6	225.0	242.1
CP*0501MS	R-404A	99.4	115.7	149.6	167.8	174.5	185.2
CP*0601MS	R-404A	106.7	123.4	157.6	175.9	182.7	193.5
CP*0701MS	R-404A	141.4	149.2	193.0	220.8	230.1	246.8
CP*0801MS	R-404A	159.6	171.6	226.1	262.5	274.6	296.3
CP*0440LS	R-404A	52.2	57.1	74.1	83.2	86.5	91.8
CP*0540LS	R-404A	75.0	81.9	104.6	116.9	121.4	128.6
CP*0600LS	R-404A	75.2	100.2	116.3	125.7	129.4	136.4
CP*0441LS	R-404A	75.2	113.7	125.6	132.4	135.4	140.5
CP*0541LS	R-404A	100.7	152.1	167.9	177.0	181.0	187.9
CP*0601LS	R-404A	105.7	146.3	169.3	150.9	187.5	195.8

Prices, product availability, and specifications are subject to change without notice.





Use your QR reader to
reference current document
version on krack.com.



Krack, a Hussmann Corporation brand

1049 Lily Cache Lane, Suite A

Bolingbrook, Illinois 60440

Ph: 630.629.7500

www.krack.com

www.hussmann.com