

# HUSSMANN®

## microSC™

## ARCH Series Self-Contained Cold-Wall Bunker with Lids

### WARNINGS:

If the information in these instructions are not followed exactly, a fire or explosion may result, causing property damage, personal injury or death.

Installation and service must be performed by a qualified installer or service agency.

**READ THE ENTIRE MANUAL BEFORE  
INSTALLING OR USING THIS EQUIPMENT.**

The unit uses R-290 gas as the refrigerant. R-290 is flammable and heavier than air. It collects first in low areas but can be circulated by the fans. If propane gas is present or even suspected, do not allow untrained personnel to attempt to find the cause. The propane gas used in the unit has no odor. The lack of smell does not indicate a lack of escaped gas. If a leak is detected, immediately evacuate all persons from the store, and contact the local fire department to advise them that a propane leak has occurred. Do not let any persons back into the store until the qualified service technician has arrived and that technician advises that it is safe to return to the store. No open flames, cigarettes or other possible sources of ignition should be used inside or in the vicinity of the units.

**FAILURE TO ABIDE BY THIS WARNING COULD  
RESULT IN AN EXPLOSION, DEATH, INJURY AND  
PROPERTY DAMAGE.**

**IMPORTANT**

Keep in store for future reference!

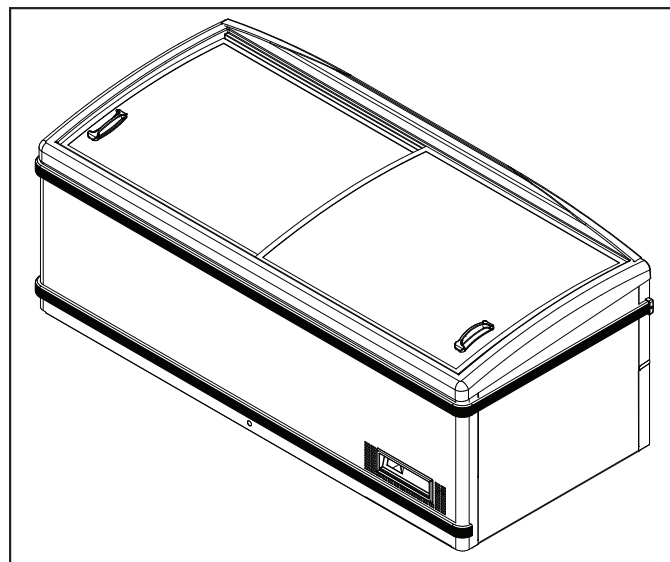

## Installation & Operation Manual

**P/N 3116321\_E**  
June 2023



## BEFORE YOU BEGIN

Read these instructions completely and carefully.

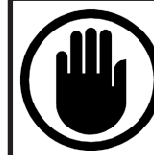

### PERSONAL PROTECTION EQUIPMENT (PPE)

Personal Protection Equipment (PPE) is required whenever installing or servicing this equipment. Always wear safety glasses, gloves, protective boots or shoes, long pants, and a long-sleeve shirt as required when installing or servicing this equipment.



## WARNING

**This refrigeration system uses hot gas defrost and incorporates a Normal Closed Solenoid. In order to remove all the refrigerant for service, the valve must be held open while the refrigerant is being evacuated. Failure to remove all the refrigerant can cause a fire or explosion.**

1. If the information in these instructions are not followed exactly, a fire or explosion may result, causing property damage, personal injury or death.
2. Installation and service must be performed by a qualified installer or service agency.
3. This unit is designed only for use with R-290 gas as the designated refrigerant.

### THE REFRIGERANT LOOP IS SEALED. ONLY A QUALIFIED TECHNICIAN SHOULD ATTEMPT TO SERVICE!

- Propane is flammable and heavier than air.
- It collects first in the low areas but can be circulated by the fans.
- If R-290 is present or even suspected, do not allow untrained personnel to attempt to find the cause.
- The propane gas used in the unit has no odor.
- The lack of smell does not indicate a lack of escaped gas.
- If a leak is detected, immediately evacuate all persons from the store, and contact the local fire department to advise them that a propane leak has occurred.
- Do not let any persons back into the store until the qualified service technician has arrived and that technician advises that it is safe to return to the store.
- A hand-held propane leak detector (“sniffer”) shall be used before any repair and/or maintenance.
- No open flames, cigarettes or other possible sources of ignition should be used inside the building where the units are located until the qualified service technician and/or local fire department determines that all propane has been cleared from the area and from the refrigeration systems.
- Component parts are designed for propane and non-incendive and non-sparking. Component parts shall only be replaced with identical repair parts.

**FAILURE TO ABIDE BY THIS WARNING COULD RESULT IN AN EXPLOSION, DEATH, INJURY AND PROPERTY DAMAGE.**

## TABLE OF CONTENTS

<p><b>PPE / R290 SERVICE</b>..... ii</p> <p><b>SAFETY</b> ..... iv</p> <p><b>ANSI Z535.5 DEFINITIONS</b> ..... iv</p> <p><b>INSTALLATION</b></p> <p>UL Listing ..... 1-1</p> <p>Federal / State Regulation ..... 1-1</p> <p>Hussmann Product Control ..... 1-1</p> <p>Shipping Damage ..... 1-1</p> <p>Location ..... 1-1</p> <p>Self Contained Location ..... 1-2</p> <p>Model Description ..... 1-2</p> <p>Unloading ..... 1-3</p> <p>Merchandiser Leveling ..... 1-3</p> <p>Adjustable Leg Levelers ..... 1-3</p> <p>Serial Plate Location ..... 1-4</p> <p>Case Lineups ..... 1-4</p> <p>Refrigeration Unit Access ..... 1-4</p> <p>Sealing Merchandiser to Floor ..... 1-4</p> <p><b>ELECTRICAL / REFRIGERATION</b></p> <p>Merchandiser Electrical Data ..... 2-1</p> <p>Field Wiring ..... 2-1</p> <p>Electrical Connections ..... 2-1</p> <p>Electrical Outlet ..... 2-1</p> <p>Refrigeration ..... 2-1</p> <p>Before Beginning any Service or Repair .. 2-2</p> <p>Replacing Refrigeration System</p> <p style="padding-left: 20px;">Components ..... 2-3</p> <p>Steps to Recover Refrigerant ..... 2-3</p> <p>Charging ..... 2-3</p> <p>Waste Outlet and Water Seal ..... 2-4</p> <p>Hot Gas Piping Layout ..... 2-5</p> <p>Wiring Diagram ..... 2-6</p> <p>Refrigeration Sequence of Operation .... 2-7</p> <p>Defrost Gas Sequence of Operation ..... 2-7</p>	<p><b>START UP / OPERATION</b></p> <p>Start Up/Operation Check List ..... 3-1</p> <p>Controller Operation (Carel Controller IR33) ..... 3-2</p> <p>Changing the Clock ..... 3-3</p> <p>Modifying the Light Timer ..... 3-3</p> <p>Set-point Adjustment..... 3-4</p> <p>Manual Defrost ..... 3-4</p> <p>How to Modify Defrost ..... 3-4</p> <p>Medium Temperature Mode-Freezer</p> <p style="padding-left: 20px;">Mode Change ..... 3-5</p> <p>Controller Operation (Carel IJF) ..... 3-6</p> <p>Applica Software ..... 3-7</p> <p>Load Limits ..... 3-18</p> <p>Stocking ..... 3-18</p> <p><b>MAINTENANCE</b></p> <p>Care and Cleaning ..... 4-1</p> <p>Removing Scratches from Bumper ..... 4-2</p> <p>Cleaning Condenser ..... 4-2</p> <p>Cleaning Glass Lids ..... 4-3</p> <p>Cleaning Defrost Channel ..... 4-3</p> <p>Condensate Pan Cleaning ..... 4-3</p> <p>Self-Contained Refrigeration Equipment</p> <p style="padding-left: 20px;">Maintenance Check List ..... 4-4</p> <p><b>SERVICE</b></p> <p>Inverter ..... 5-1</p> <p>Sensor Replacement ..... 5-2</p> <p>Fan Motor ..... 5-2</p> <p>Compressor ..... 5-3</p> <p>Replacing Gaskets ..... 5-3</p> <p>Replacing LED Lighting ..... 5-4</p> <p>Replacing Drain Heater ..... 5-4</p> <p>Replacing Lids Handles..... 5-5</p> <p>Replacing Bumpers ..... 5-5</p> <p>Case Problem / Resolution Guide ..... 5-6</p> <p>Case Exploded Part Views ..... 5-8</p>
--	---

**SAFETY**

This manual was written in accordance with originally prescribed equipment that is subject to change. Hussmann reserves the right to change or revise specifications and product design in connection with any feature of our products.



Only qualified personnel should install and service this equipment. Servicing is only to be done by factory authorized personnel. Observe all precautions on tags, stickers, labels and literature attached to this equipment. Component parts shall be replaced with like components. Service is to be performed by factory-authorized service personnel, so as to minimize the risk of possible ignition due to incorrect parts or improper service. Contact your Hussmann representative to arrange servicing.

The safety of our customers and employees is paramount. The precautions and procedures described in this manual are intended as general methods for safe use of this equipment. Please be sure to comply with the precautions described in this manual to protect you and others from possible harm, and follow OSHA standards for safety.

The definitions at right are used to clarify the magnitude and urgency of harm and damage, considering problems arising from misuse. Relative to their potential danger, the definitions are divided into four parts according to ANSI Z535 Series.

\*\*\*\*\*

**ANSI Z535.5 DEFINITIONS**

-  • **DANGER** – Indicate[s] a hazardous situation which, if not avoided, will result in death or serious injury.
-  • **WARNING** – Indicate[s] a hazardous situation which, if not avoided, could result in death or serious injury.
-  • **CAUTION** – Indicate[s] a hazardous situation which, if not avoided, could result in minor or moderate injury.
- **NOTICE** – *Not related to personal injury* – Indicates[s] situations, which if not avoided, could result in damage to equipment.

**REVISION HISTORY**

- REVISION E** — Added IJF Controller Instructions
- REVISION D** — Updated Hot Gas Piping Layout, Page 2-5
- REVISION C** — Updated Medium Temp. Mode, Page 3-5
- REVISION B** — ORIGINAL RELEASE

ATTENTION

Merchandiser must operate for 24 hours before loading product!

Regularly check merchandiser temperatures.

Do not break the cold chain. Keep products in cooler before loading into merchandiser.

These merchandisers are designed for only pre-chilled products.



FOR CALIFORNIA INSTALLATIONS ONLY:

WARNING:

Cancer and Reproductive Harm

[www.P65Warnings.ca.gov](http://www.P65Warnings.ca.gov)

August 31, 2018
3069575

---

This warning does not mean that Hussmann products will cause cancer or reproductive harm, or is in violation of any product-safety standards or requirements. As clarified by the California State government, Proposition 65 can be considered more of a ‘right to know’ law than a pure product safety law. When used as designed, Hussmann believes that our products are not harmful. We provide the Proposition 65 warning to stay in compliance with California State law. It is your responsibility to provide accurate Proposition 65 warning labels to your customers when necessary. For more information on Proposition 65, please visit the California State government website.

## INSTALLATION

### UL LISTING

These merchandisers are manufactured to meet ANSI/ UL 471 standard requirements for safety. Proper installation is required to maintain the listing.

### FEDERAL / STATE REGULATION

These merchandisers at the time they are manufactured, meet all federal and state/provincial regulations. Proper installation is required to ensure these standards are maintained. Near the serial plate, each merchandiser carries a label identifying the environment for which the merchandiser was designed for use. These cases meet Type I & Type II conditions.

**ANSI/NSF-7 Type I – Display Refrigerator / Freezer  
Intended for 75°F (24°C) / 55% RH Ambient Application**

**ANSI/NSF-7 Type II – Display Refrigerator / Freezer  
Intended for 80°F / 55%RH Ambient Application**

**ANSI/NSF-7 – Display Refrigerator**

### Environmental Concerns

If disposing of this equipment at end of useful life-cycle, consult with local authorities for proper disposal of merchandiser parts that are foamed using cyclopentane as the blowing agent.

### HUSSMANN PRODUCT CONTROL

The serial number and shipping date of all equipment is recorded in Hussmann's files for warranty and replacement part purposes. All correspondence pertaining to warranty or parts ordering must include the serial number of each piece of equipment involved. This is to ensure the customer is provided with the correct parts.

### SHIPPING DAMAGE

All equipment should be thoroughly examined for shipping damage before and during unloading. This equipment has been carefully inspected at our factory. Any claim for loss or damage must be made to the carrier. The carrier will provide any necessary inspection reports and/or claim forms.

### Apparent Loss or Damage

If there is an obvious loss or damage, it must be noted on the freight bill or express receipt and signed by the carrier's agent; otherwise, carrier may refuse claim. Do not under any circumstances connect a damaged cabinet to the electric circuit. Otherwise, there is the risk of electric shock or refrigerant leakage!

### Concealed Loss or Damage

When loss or damage is not apparent until after equipment is uncrated, retain all packing materials and submit a written response to the carrier for inspection within 15 days.

### LOCATION

These merchandisers are designed for displaying products in air conditioned stores where temperature is maintained at or below the ANSI / NSF-7 specified level and relative humidity is maintained at or below 55%.

**Recommended operating ambient temperature is between 65°F (18°C) to 80°F (26.7°C). Maximum relative humidity is 55%.**

**LOCATION (CONTINUED)**

Placing refrigerated merchandisers in direct sunlight, near hot tables or near other heat sources could impair their efficiency. Like other merchandisers, these merchandisers are sensitive to air disturbances. Air currents passing around merchandisers will seriously impair their operation.

Do NOT allow air conditioning, electric fans, open doors or windows, etc. to create air currents around the merchandiser. For the equipment’s proper installation, check if it is placed on an even surface and not near sources of heat and/or direct solar radiation or near doors, windows, fans, and vents.



Maintain a minimum 150 mm or 5.9 inches at rear of case.

**⚠ WARNING**  
 Case ventilation openings must be clear of any obstructions. Do not damage the refrigerant circuit.

**⚠ WARNING**  
 Do NOT stand or walk on top of merchandiser. Do not store items or flammable materials atop the unit.

**SELF CONTAINED (LOCATION)**

Product should always be maintained at proper temperature. This means that from the time the product is received, through storage, preparation and display, the temperature of the product must be controlled to maximize the life of the product. In humid environments with a large concentration of salt, like fish markets, be sure water does not come directly into contact with the compressor area.

**BE SURE TO POSITION SELF CONTAINED MERCHANDISERS PROPERLY.**

SELF CONTAINED models have vented base panels to allow air circulation through the condensing unit. These panels are located around the condensing unit.

Allow for a minimum 150 mm or 5.9 inches of clearance from walls, merchandisers, and any other large objects near the merchandiser’s vented base panels at the rear of the case(s). The equipment must be placed in a well-ventilated area. Blocking or restricting air flow will adversely affect performance and may damage the refrigeration system.

**MODEL DESCRIPTION**

These models are island, spot display cases. Each self-contained model has its own condensing unit, factory installed beneath the display area of the case ready for operation when electrical service is connected.

## UNLOADING

### Unloading from Trailer:

Each merchandiser is shipped within a crate intended to protect it and allow it to be easily moved. Please **DO NOT** remove the merchandiser from the crate until it is as close as possible to its permanent location.

To remove the crate from the trailer, use a lever bar (also known as a Mule, Johnson Bar, J-bar, Lever Dolly, or Pry Lever), forklift, or dolly.

**DO NOT** drag the crate. Move the crate near the final merchandiser setup location.

To remove the merchandiser from the crate, remove all braces, the top, and sides. Lift the merchandiser off of the base skid.

**DO NOT** lay the merchandiser on its side or back to remove it from the crate. Use care to not damage the merchandiser during this process. Once the shipping skid is removed, the merchandiser must be lifted — **NOT PUSHED**.



## MERCHANDISER LEVELING

**BE SURE TO POSITION MERCHANDISERS PROPERLY.** Check floor where cases are to be set to see if it is a level area. Determine the highest part of the floor. Level the merchandiser by all four corners. Merchandiser(s) must be installed level to ensure proper operation of the refrigeration system and to ensure proper drainage of defrost water.

## ADJUSTABLE LEG LEVELERS

Leg with levelers are provided with the case. A wood block can be used to raise the case in order to lower the feet.

### Installation of mounting legs with levelers:

1. Use a J bar to lift the case and install a block of wood to provide clearance to install the legs.

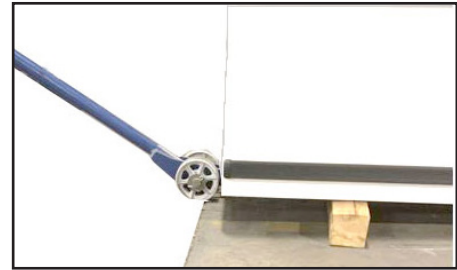

2. Install the legs, and secure with self tapping screws. Use machine screws on the condensing unit compartment to avoid sharp points.

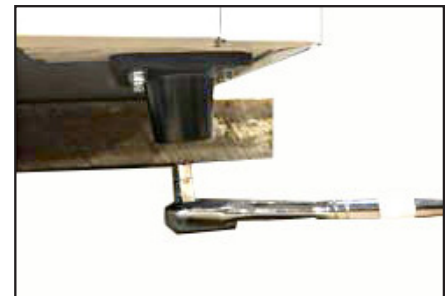

3. Screw in the leveling legs and adjust to provide a level case.

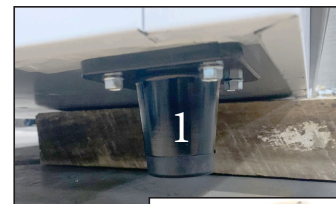

# 1-4 INSTALLATION

## SERIAL PLATE LOCATION

The serial plate is located on the back of the unit near refrigeration system.



## CASE LINEUPS

The merchandiser can be setup standalone, in an end-to-end lineup, a back-to-back configuration, or in an island configuration.

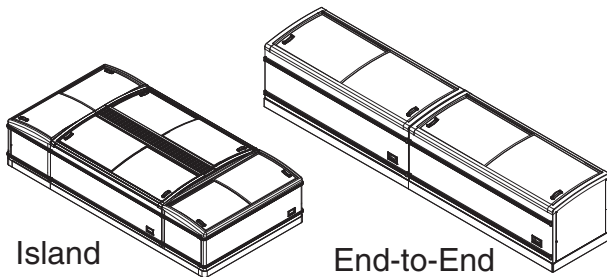

For cases in an end-to-end adjacent lineup, use bracket below to connect and join kickguards.

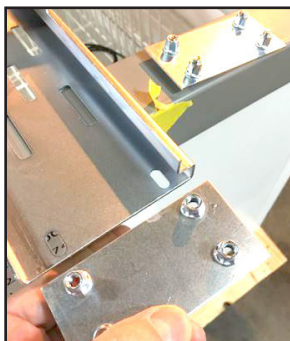

## REFRIGERATION UNIT ACCESS

Remove side panel screws to gain access to the condensing unit. Check inside this panel to make sure all electrical wiring is secured, and that there is no damage to the unit from shipment or placement. Confirm there are no refrigerant leaks during startup of the case(s).



## SEALING MERCHANDISER TO FLOOR

If required by local sanitary codes, or if the customer desires, merchandisers may be sealed to the floor. The size needed will depend on how much variation there is in the floor, from one end of the merchandiser to the other. Sealing of the lower front and rear panels on self contained models may hamper their removal for servicing or maintenance of the condensing unit.

**NOTE:** Do not allow trim to cover any intake or discharge grilles located in the lower front panel.

CAUTION

**Do not climb on or get inside the equipment. Materials in the case could break and presents a risk of physical injury and damage to the equipment.**



## ELECTRICAL / REFRIGERATION

### MERCHANDISER ELECTRICAL DATA

Refer to the technical data sheets and case serial plate for electrical information.

### FIELD WIRING

Field wiring must be sized for component amperes stamped on the serial plate. Actual ampere draw may be less than specified.

**ALWAYS CHECK THE SERIAL PLATE FOR COMPONENT AMPERES**

### ELECTRICAL CONNECTIONS

All wiring must be in compliance with NEC and local codes.

### ELECTRICAL OUTLET:

Before the merchandiser is connected to any wall circuit, use a voltmeter to check that the outlet is at 100% of the rated voltage. The wall circuit must be dedicated for the merchandiser. Failure to do so voids the warranty. Do not use an extension cord. Never plug in more than one merchandiser per electrical circuit.

- Always use a dedicated circuit with the amperage stated on the unit.
- Plug into an outlet designed for the plug.
- Do not overload the circuit
- Do not use long or thin extension cords. Never use adapters.
- If in doubt, call an electrician.

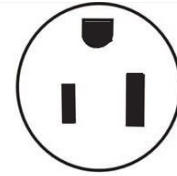

**NEMA 5-15P  
Plug**

Self-contained models have factory-installed power cords attached at the electrical box. If the power cord is damaged, it must be replaced by personnel qualified for this task to prevent hazardous situations.



**WARNING**

**Merchandiser must be grounded.  
Do not remove the power supply cord ground.**



**CAUTION**

**Risk of Electric Shock. If cord or plug becomes damaged, replace only with a cord and plug of the same type.**

### REFRIGERATION

Each model is equipped with its own condensing unit and control panel located underneath the display area behind the vented panels. The correct type of refrigerant will be stamped on each merchandiser's serial plate. The merchandiser refrigeration piping is leak tested.

### Before Beginning Any Service or Repair:

Use a hand-held propane leak detector (“sniffer”) to ensure no propane is present in the immediate area, the inside of the display case and the inside of the refrigeration system. R-290 is an odorless refrigerant. Keep the area clear of all customers and non-essential or unauthorized personnel.

Verify that all repair parts are identical models to the ones they are replacing. Do not substitute parts such as motors, switches, relays, heaters, compressors, power supplies or solenoids. Failure to do so can result in an explosion, death, injury and property damage. Parts used on hydrocarbon cases must meet specific UL certification for non-incendive or non-sparking components. Use only Hussmann approved parts approved through the Hussmann Performance Parts Website. <https://parts.hussmann.com/> See Appendix for parts list.

Brazing must not begin before all propane has been cleared from the immediate area — the inside of the displays case and the inside of the refrigeration system.

## **WARNING**

**Only Hussmann or factory trained technicians should service or repair this R-290 (propane) equipment.**

**Failure to follow instructions can result in an explosion, death, injury and property damage.**

## **WARNING**

**This refrigeration system uses hot gas defrost and incorporates a Normal Closed Solenoid. In order to remove all the refrigerant for service, the valve must be held open while the refrigerant is being evacuated. Failure to remove all the refrigerant can cause a fire or explosion.**

## **WARNING**

**Refrigeration lines are under pressure. Refrigerant must be recovered before attempting any connection or repair.**

If a leak is detected, follow store safety procedures. It is the store’s responsibility to have a written safety procedure in place. The safety procedure must comply with all applicable codes such as local fire department’s codes.

At minimum, the following actions are required:

- Immediately evacuate all persons from the store, and contact the local fire department to advise them that a propane leak has occurred.
- Call Hussmann and/or a qualified service agent and inform them that a propane sensor has detected the presence of propane.
- Do not let any persons back into the store until the qualified service technician has arrived and that technician advises that it is safe to return to the store.

- The propane gas used in the unit has no odor. The lack of smell does not indicate a lack of escaped gas.

- A hand-held propane leak detector (“sniffer”) should be used before any repair and/or maintenance is attempted. All repair parts must be identical models to the ones they are replacing.
- No open flames, cigarettes or other possible sources of ignition should be used inside the building where the units are located until the qualified service technician and/or local fire department determines that all propane has been cleared from the area and from the refrigeration systems.

## REPLACING REFRIGERATION SYSTEM COMPONENTS

### DANGER

**Only Hussmann service technicians or technicians qualified to handle R-290 (propane) refrigerant should service or repair this R-290 (propane) equipment. Failure to follow instructions can result in an explosion, death, injury and property damage.**

### STEPS TO RECOVER REFRIGERANT

1. Make sure you are in a well ventilated area before making any service or repair to the refrigeration system.
2. Disconnect all power sources from the system. Some systems may have more than one plug or power supply.
3. Tap system with line tap valves, attaching gauges to the high and low sides of the system.

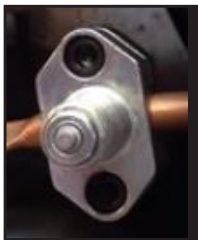

**refrigeration  
line tapping  
valve**

4. Connect hose to an evacuated recovery tank. Open refrigeration gauges and recovery tank.

### WARNING

**This refrigeration system uses hot gas defrost and incorporates a Normal Closed Solenoid. In order to remove all the refrigerant for service, the valve must be held open while the refrigerant is being evacuated. Failure to remove all the refrigerant can cause a fire or explosion.**

5. With the suction valve in vacuum, the refrigerant will be recovered into the recovery tank.
6. Once recovered, close the tank valve and remove the gauge from the tank and connect nitrogen tank to the system to purge it with nitrogen.
7. Pull vacuum to a minimum of 200 microns or lower.



### CHARGING

A calibrated scale with +/-2 gram accuracy must be used to charge the system. The charge amount is shown on the serial plate. Only R-290 grade refrigerant can be used. Standard propane does not meet the purity/moisture content of R-290, and therefore cannot be used to charge cases.

No gas charge adjustments are allowed. When connecting hoses between the refrigeration system, manifold gauges, and refrigerant cylinder, ensure that the connections are secure and there are no potential sources of ignition nearby. Ensure that contamination of different refrigerants does not occur when using charging equipment. Use dedicated hoses to service R-290 (propane) refrigeration systems. Hoses or lines should be as short as possible to minimize the amount of refrigerant contained in them.

Ensure that the refrigeration system is properly grounded prior to charging the system with refrigerant, to avoid the potential for static build-up.

Extreme care must be taken not to overfill the refrigeration system. After charging, carefully disconnect the hoses, attempting to minimize the quantity of refrigerant released.

Further leak check the service ports, hoses, refrigerant tanks. The service ports shall be checked for leaks using a hydrocarbon leak detector with a sensitivity of 3 grams/year (0.106 Oz/year) leak rate.



Thoroughly leak check the service ports. If no leak is present, use a pinch-off tool to close the ends of the service tubes before brazing them shut. Remove all service ports.

If a Schrader valve is used on the compressor service tube, it must be removed and the previous steps followed in order to braze the service tube shut.

## **⚠️ WARNING**

— LOCK OUT / TAG OUT —

*To avoid serious injury or death from electrical shock, always disconnect the electrical power at the main disconnect when servicing or replacing any electrical component. This includes, but is not limited to, such items as doors, lights, fans, heaters, and thermostats.*

## WASTE OUTLET AND WATER SEAL

These merchandisers have one waste outlet located on the right side, front of case. A p-trap or water seal may be installed to prevent air leakage and insect entrance.

**Before starting the case, put in a small amount of water as shown below to provide a water seal otherwise frost and ice may form.**



Install the drain screen (shown below). Drain screen is included with the kit packout.



## **⚠️ WARNING**

**Component parts shall be replaced with like components, and servicing shall be done by factory authorized service personnel only, so as to minimize the risk of possible ignition due to incorrect parts or improper service.**

HOT GAS PIPING LAYOUT

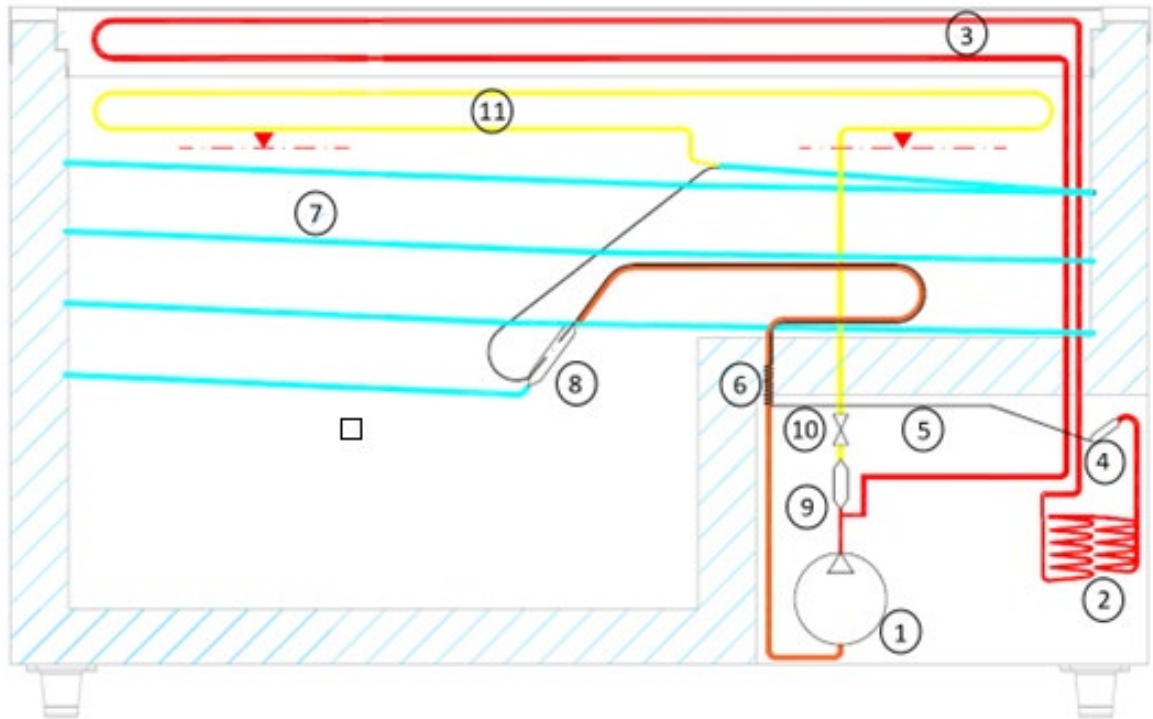

1. Compressor
2. Condenser
3. Skin Condenser
4. Filter Dryer
5. Capillary
6. Heat Exchanger
7. Evaporator
8. Accumulator
9. Filter Strainer
10. Defrost Valve
11. Defrost Line

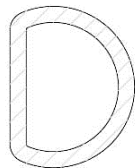

“D” Shaped evaporator

**⚠ WARNING**

This refrigeration system uses hot gas defrost and incorporates a Normal Closed Solenoid. In order to remove all the refrigerant for service, the valve must be held open while the refrigerant is being evacuated. Failure to remove all the refrigerant can cause a fire or explosion.

WIRING DIAGRAM

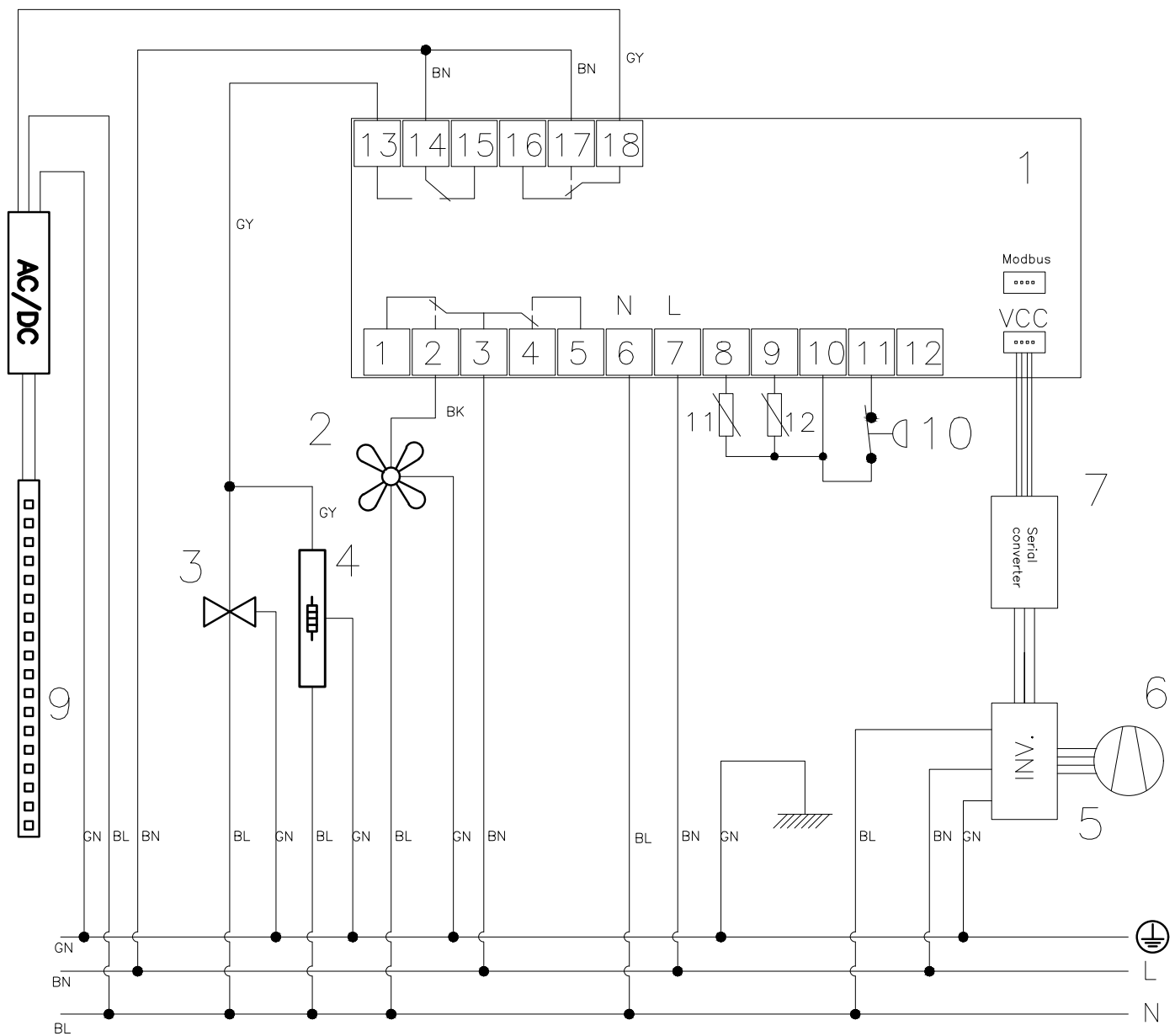

- 1 – Controller
- 2 – Condenser Fan
- 3 – Defrost valve
- 4 – Defrost Heater
- 5 – Inverter do compressor
- 6 – Compressor
- 7 – Serial Converter
- 8 – LED Power Supply
- 9 – LED bar(s)
- 10 – Pressure Switch
- 11 – Ambient Probe
- 12 – Defrost probe

- BL = Blue
- BK = Black
- BN = Brown
- GN = Green
- GY = Grey

**REFRIGERATION SEQUENCE OF OPERATION**

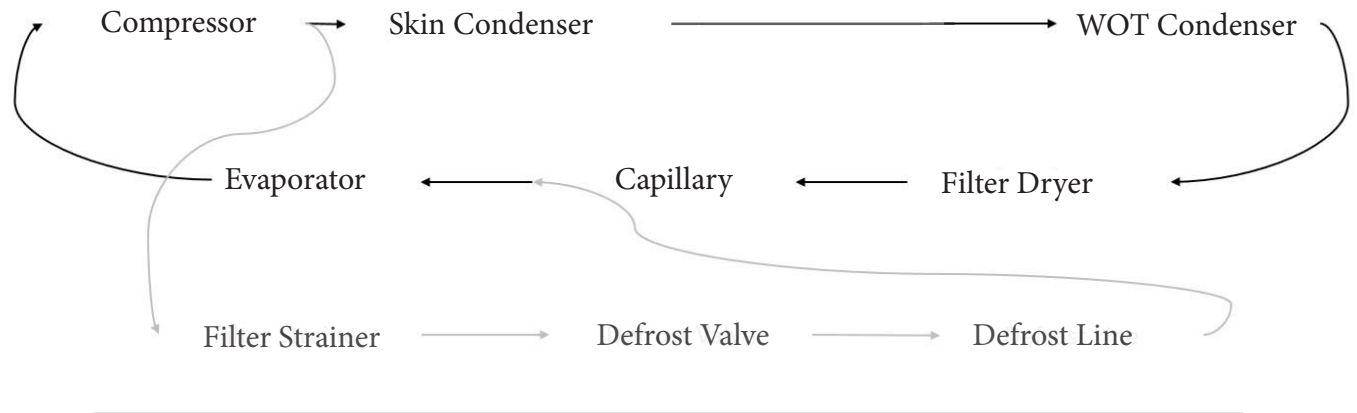

**DEFROST GAS SEQUENCE OF OPERATION**

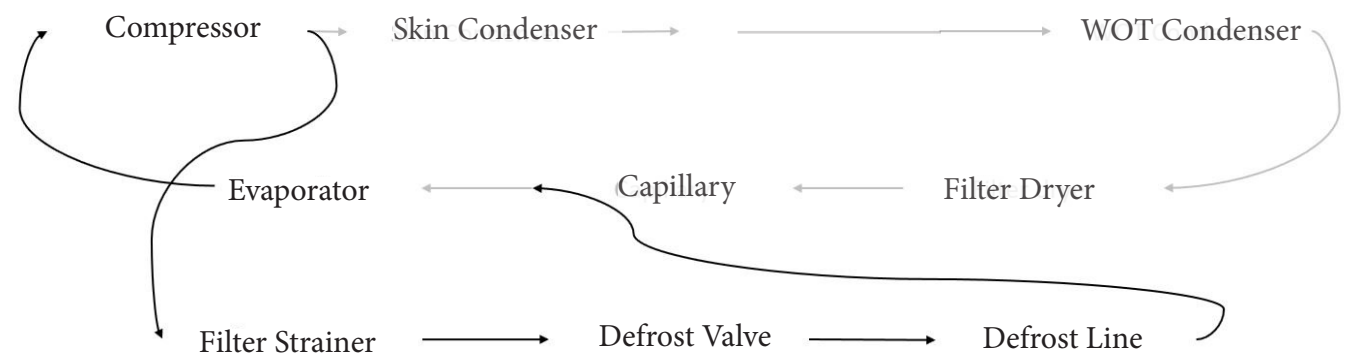

Interior electric drain heater



During defrost, the defrost solenoid valve is energized and held open allowing the gas to be redirected through the evaporator. Also the defrost condensate shown in the picture is energized. Defrost is temperature terminated with a failsafe that is 45 minutes. Normally only 1 defrost per day is required.

**2-8           INSTALLATION**

NOTES:



## START UP / OPERATION

### Hussmann Self-Contained Refrigeration Equipment Start Up Check List

\*\*\*Please note that failure to follow this start-up document may void your factory warranty\*\*\*

Step	Startup Activity	Check
1	Locate, read and keep install/operation manual in a safe place for future reference.	<input type="checkbox"/>
2	Examine unit. Confirm there is NO damage or concealed damage.	<input type="checkbox"/>
3	Level the unit, side to side and front to rear.	<input type="checkbox"/>
4	Remove all shipping brackets/compressor straps/bolts etc.	<input type="checkbox"/>
5	Unit must be run on a dedicated electrical circuit. Do not use adapters.	<input type="checkbox"/>
6	Ensure that the proper electrical requirements for the equipment are supplied.	<input type="checkbox"/>
7	Verify all electrical wiring is secured and clear of any sharp edges or hot lines. Connect plug to the outlet.	<input type="checkbox"/>
8	Some water should be placed in the drain to close the siphon and prevent formation of ice.	<input type="checkbox"/>
9	Confirm drain trap is secure. Prime drain to prevent air entering case.	<input type="checkbox"/>
10	Verify all required clearances on the sides and back of unit.	<input type="checkbox"/>
11	Verify there are no air disturbances external to the unit. Heat and air registers, fans, and doors etc.	<input type="checkbox"/>
<p><b>Advise owner/operator that merchandiser must operate at temperature for 24 hrs prior to loading with product.</b></p>		

**LEGAL DISCLAIMER:**

Hussmann shall not be liable for any repair or replacements made without the written consent of Hussmann, or when the product is installed or operated in a manner contrary to the printed instructions covering installation and service which accompanied such product.





## 3-2 STARTUP / OPERATION

### CONTROLLER OPERATION (Carel Controller IR33)

The electronic controller is located at the lower, righthand front of the case. The controller comes factory set, and is ready for use. The cases have predetermined factory temperature settings. Activate manual defrost by pressing and holding  for 5 seconds. The factory setting is -15° F to hold ice cream temperatures.

The case setpoint has been factory set, but the clock will need to be set to the local time. The case is set to defrost at 11:00 pm. The lights are set to come on at 6:00 am and turn off at 10 pm.



Key	Press Key
 PRG/MUTE	Press down for more than 3 seconds, access the “F” parameters (frequent) or the menu to define the password or access the “C” (settings) parameters menu; If there is an active alarm, silence the alarm.
 ON-OFF/UP	Press down for more than 3 seconds to turn OFF the control panel; Press down for more than 1 second to turn ON the control panel; Upon defining parameters, increase the amount exhibited or switch over to the next parameter.
 AUX/DOWN	Press down for more than 1 second to activate/deactivate the auxiliary output (lighting); Upon defining parameters, decrease the amount exhibited or switch over to the previous parameter.
 SET/DEF	Press down for more than 1 second to view and/or allow the user to define the set point; Press down for more than 5 seconds to initiate manual defrosting.

### CHANGING THE CLOCK

Press the key for 3 seconds. 

Introduce the corresponding password: “22”.

Confirm by pressing the key. 

Navigate through the corresponding parameters by pressing the keys  and/or  and modify according to the following table.

Parameters for modification	Meaning	Action
Tc-y	Current year	Validate with  key.
Tc-m	Current month	
Tc-d	Current day of the month	
Tc-u	Current day of the week	
Tc-h	Current hour	
Tc-n	Current minute	

#### NOTES:

After modifying all the parameters, record them by pressing down the key  continuously until the temperature appears.

### MODIFYING THE LIGHT TIMER

The case(s) are programmed to turn the lights on at 6:00 am and turnoff at 11:00 pm. To change these times follow this procedure:

Navigate through parameters to change:

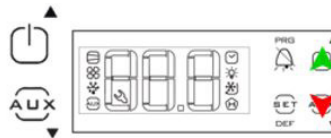

#### Light ON

- ton-d – day to turn ON (“11” means every day)
- ton-h – hour to turn ON
- ton-n – minute to turn ON

#### Light OFF

- toF-d – day to turn OFF (“11” means every day)
- toF-h – hour to turn OFF
- toF-n – minute to turn OFF



C	ton	Light/aux on time
	d	Day
	h	Hour
	n	Minute
C	toF	Light/aux off time
	d	Day
	h	Hour
	n	Minute

Validate with button SET  
(Single Press)



Save with button PRG  
(Long Press)

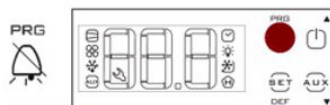

**SETPOINT ADJUSTMENT**

Press the SET button.



Change the Set Point Value.

Confirm with the SET button again to confirm.



NOTE:

The discharge air temperature for ice cream/ frozen foods is -14.8° to -10°F and 30° to 34° for Medium Temp.

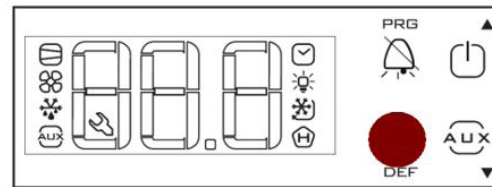
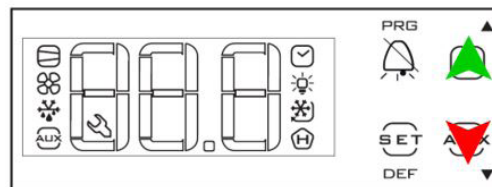
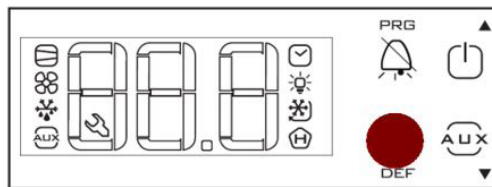

**MANUAL DEFROST**

Press the SET button.

(5-second long press)

The message DEF shows on the display.



**HOW TO MODIFY DEFROST**

Navigate through parameters and change

Parameters to change:

- td1-d - 1 defrost per day (11:30)
- td1-h - 1st defrost hour
- td1-n - 1st defrost minute

Validate with the SET button

Save with the PRG button (long press)

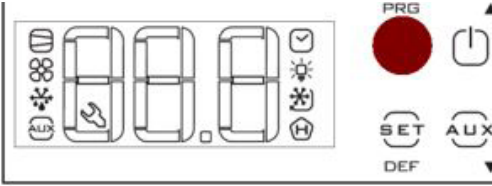
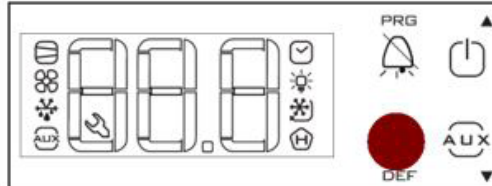
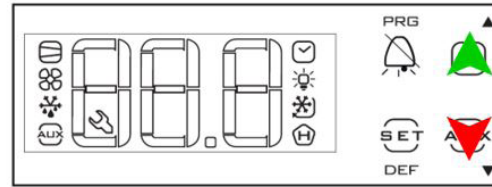
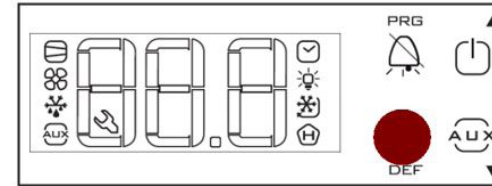

**MEDIUM TEMPERATURE MODE - FREEZER MODE CHANGE**

1. Press and hold the PRG button + Down Arrow (AUX) button until “bn0” appears in the display. During the process the controller will restart. Always hold the button until “bn0” appears.

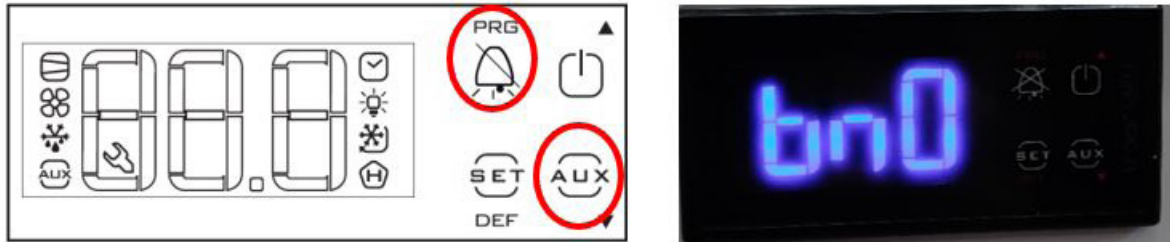

2. The display shows the value “bn0”.
3. Use the buttons “up” and “down” to switch between the possible settings:
  - a. bn1 – Freezer mode
  - b. bn2 – Medium Temperature mode

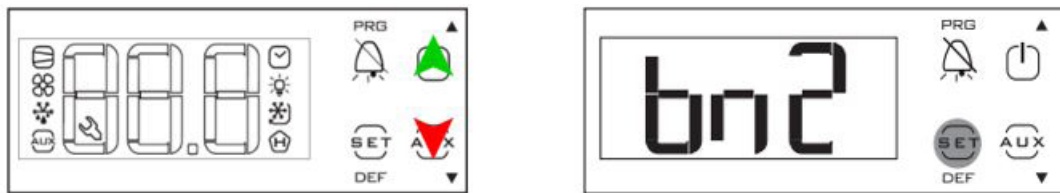

4. Press the “SET” button to select the desired mode. The controller will restart.

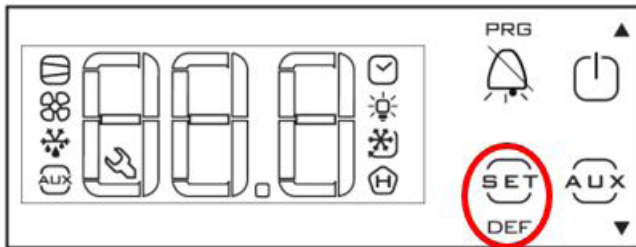

5. After restart, press the “SET” button to verify the Setpoint.

**CAUTION**

In medium temp mode, the wire rack shelving needs to be above the compressor bay to prevent freezing of product.

In medium temperature mode, the products should be used above the compressor bay line (the temperature in the bottom could be too low).

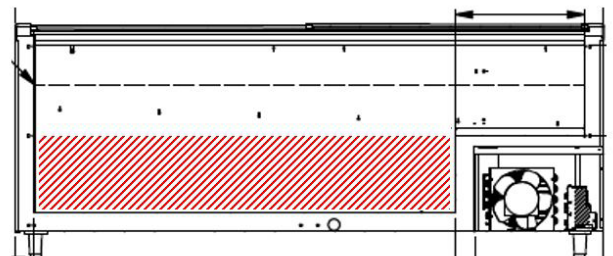

**CONTROLLER OPERATION**

(Carel IJF)

The electronic controller is located at the lower, righthand front of the case. The controller comes factory set and is ready for use. The cases have predetermined factory temperature settings. Activate manual defrost in the Applica App by pressing the defrost icon for 1 second. The factory setting is -15° F to hold ice cream temperatures. The case setpoint has been factory set, but the clock must be set to the local time. Is the case set to defrost at 11:00 pm? Are the lights set to come on at 6:00 am? And turn off at 10 pm?

**2. Display Panel**

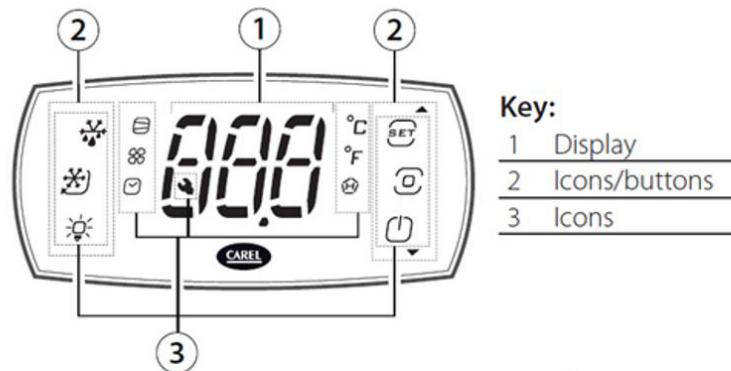

### APPLICA CAREL SOFTWARE

Carel apps can be used to configure the controller from a mobile device (smartphone, tablet), via NFC (Near Field Communication) or BLE (Bluetooth Low Energy).

Supported Devices: Android 5.1, iOS 10, Bluetooth® 4.0 and above.

Software can be downloaded from Google Play Store or Apple App Store

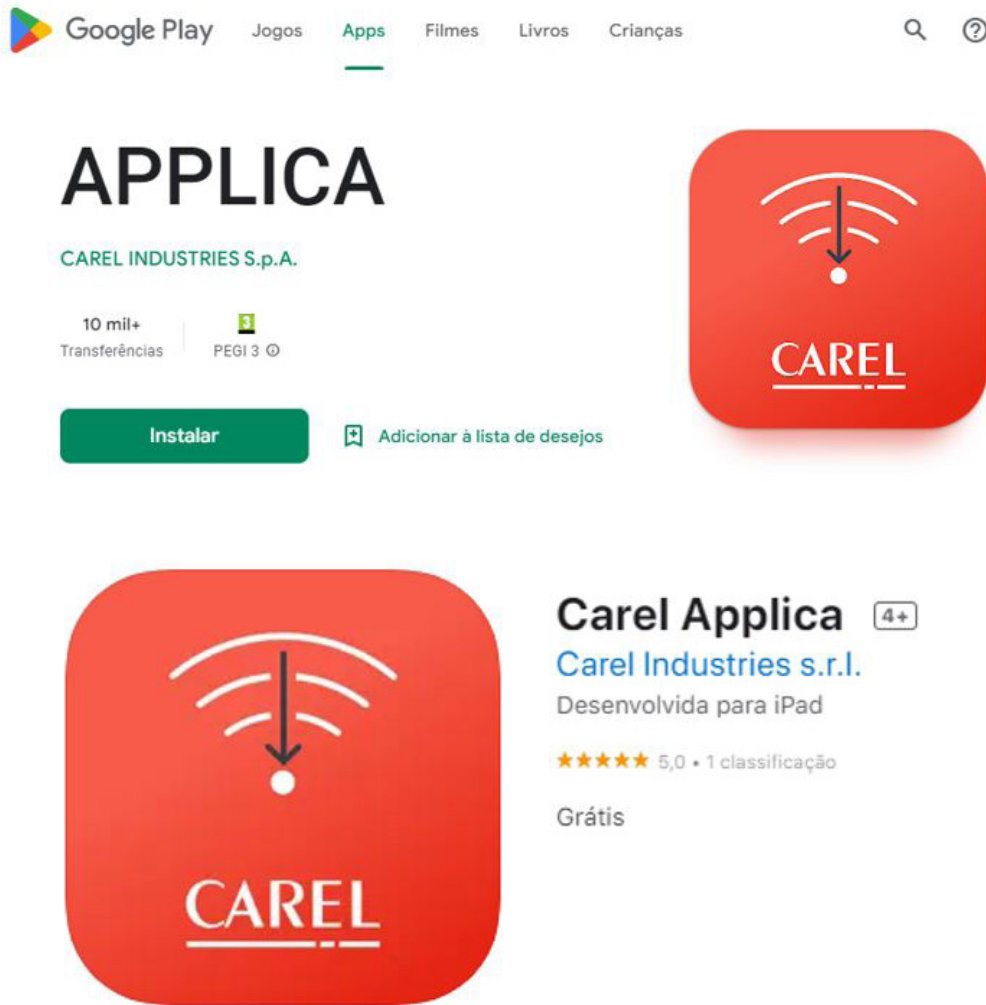

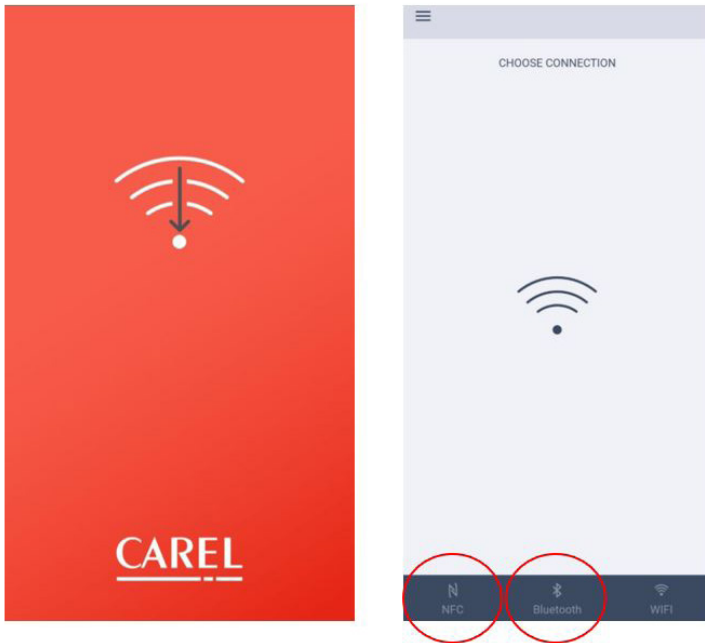



Need to choose NFC or Bluetooth connection.

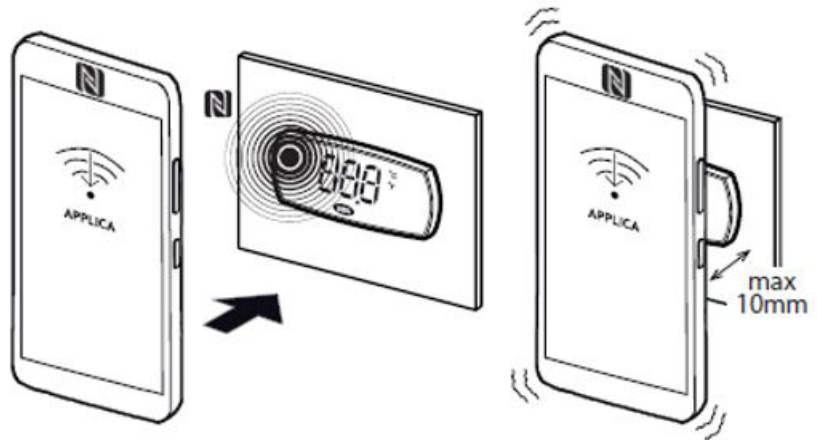

  
Make sure NFC or Bluetooth has been activated. Some smartphones may have problems if the location is not enabled.



  
During Bluetooth® connection, the iJF user terminal is disabled and shows the message “bLE.”

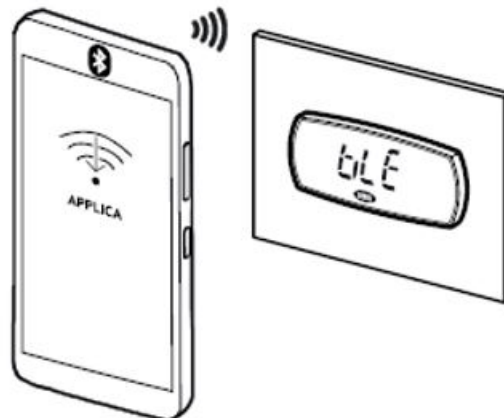



### APPLICA SOFTWARE - NFC CONNECTION

It is necessary to touch the mobile phone (the zone where the NFC is) to the controller (front panel) to read the data from the controller.

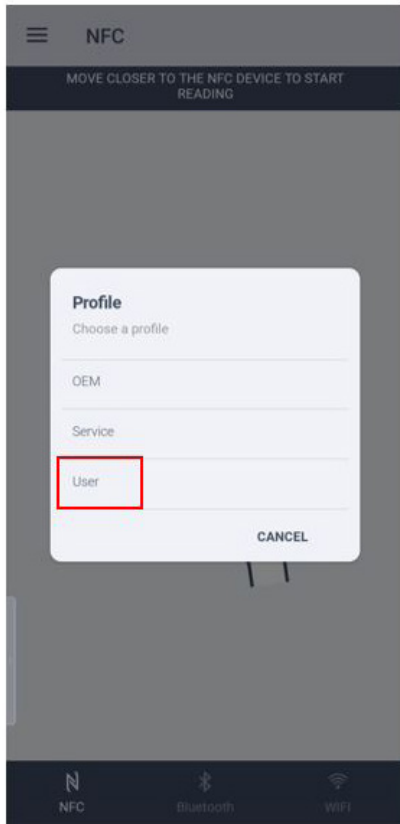

Password Menu

User password: 0  
Service password: 22

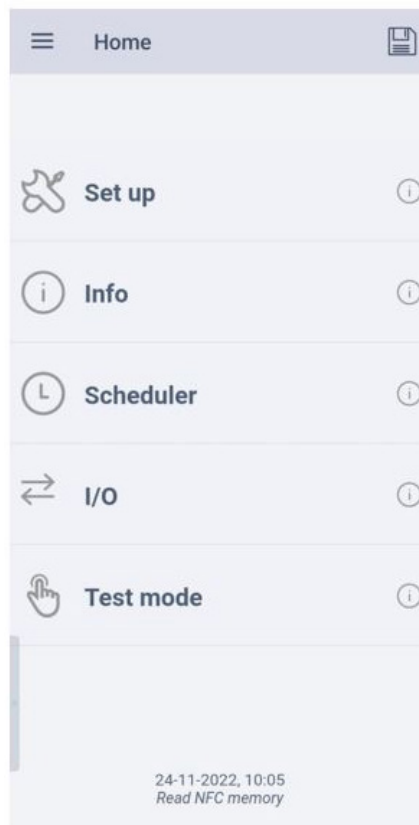
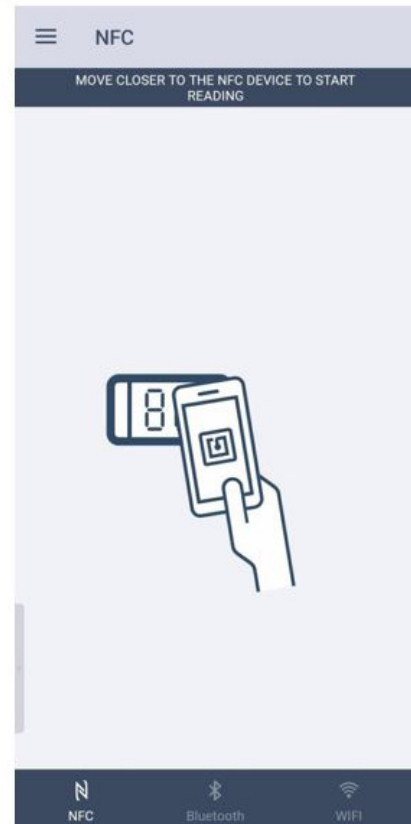

NFC Home Menu

APPLICA SOFTWARE - BLUETOOTH CONNECTION

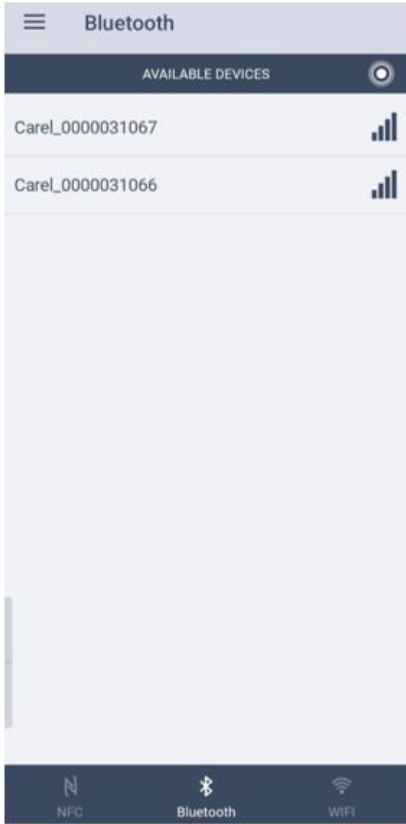

Need to select the correct controller (the one with the strongest signal - closest)

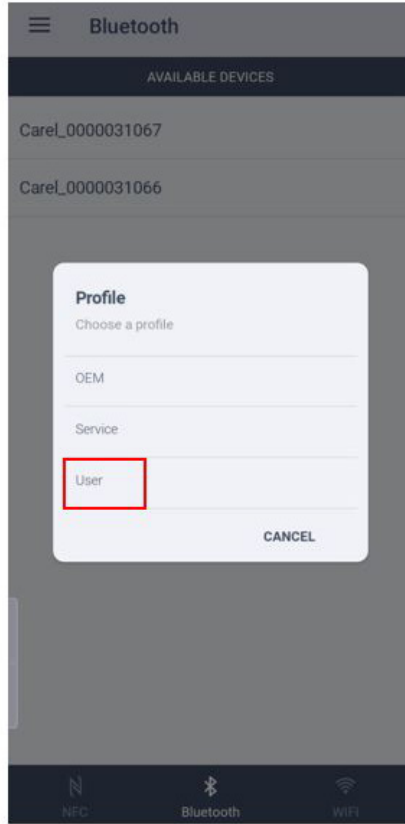

Password Menu

User password: 0  
Service password: 22

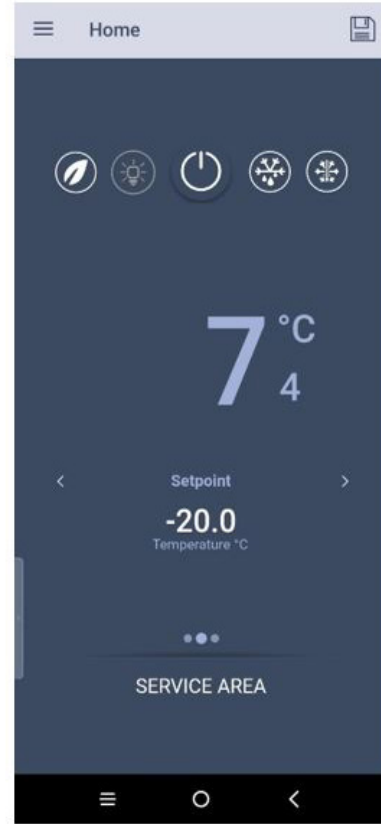

Bluetooth Home Menu

APPLICA SOFTWARE - PERFORM MANUAL DEFROST

- 1. Press 
- 2. Check if the icon  changes color



APPLICA SOFTWARE - UPDATE REAL TIME CLOCK

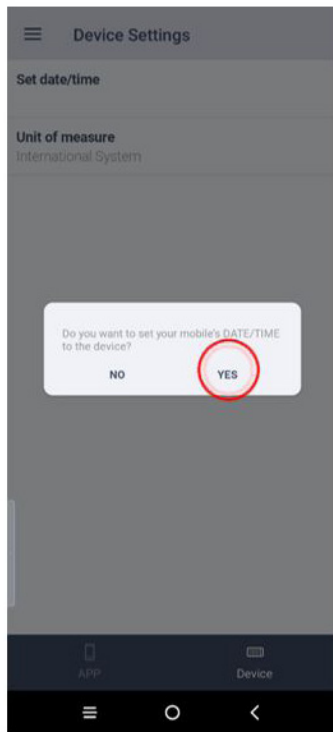
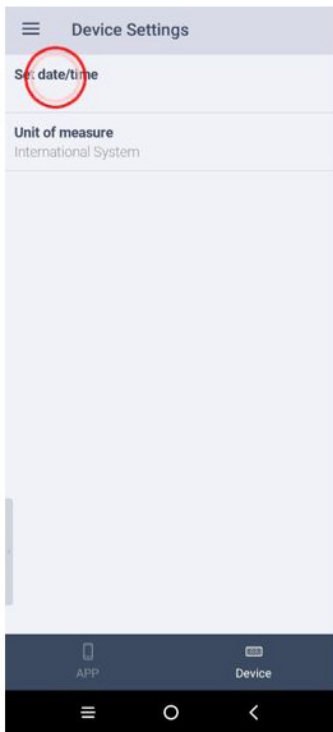
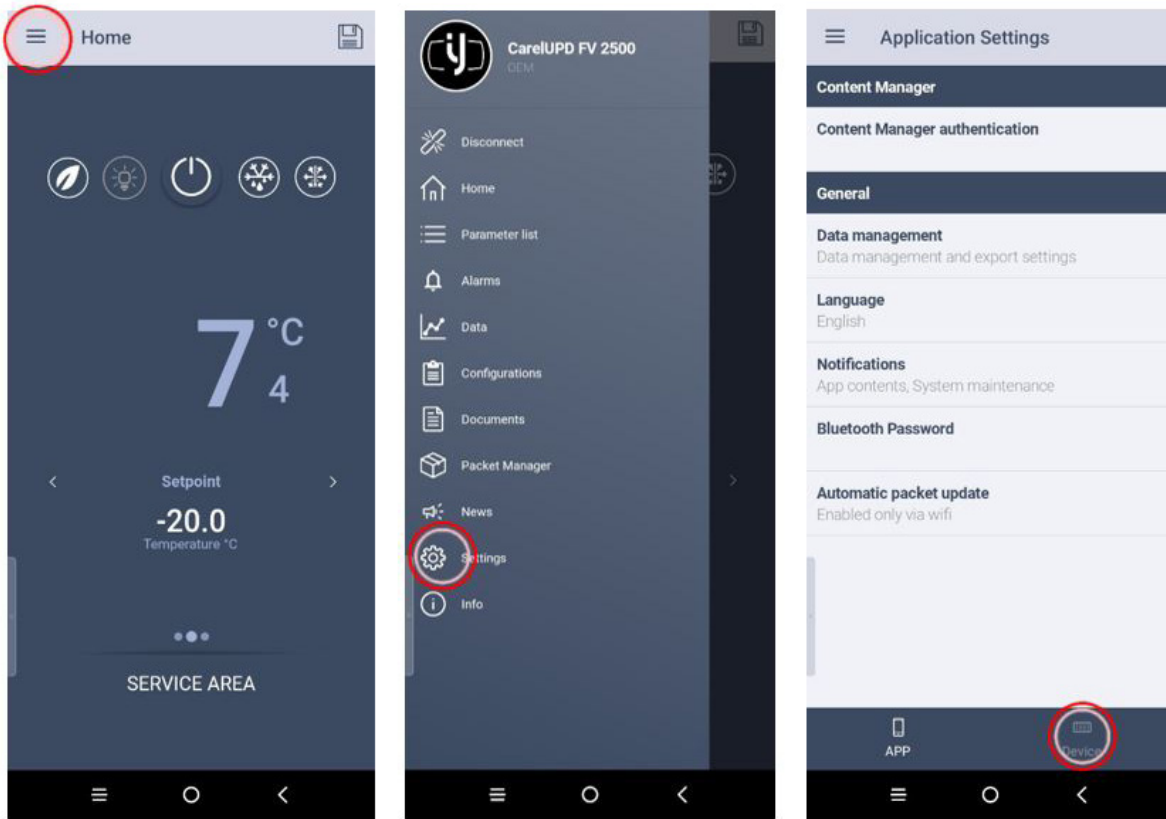

1. Press 
2. Press SETTINGS
3. Press DEVICE
4. Press SET DATE / TIME
5. Select YES

**Only on NFC connection**

**Warning**  
 For the changes to take effect, it is necessary to manually write the parameters through one of the following:  
 - Button   
 - Action "Write"

Don't show this dialog again

OK

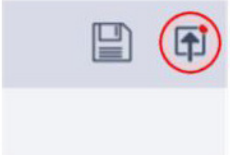

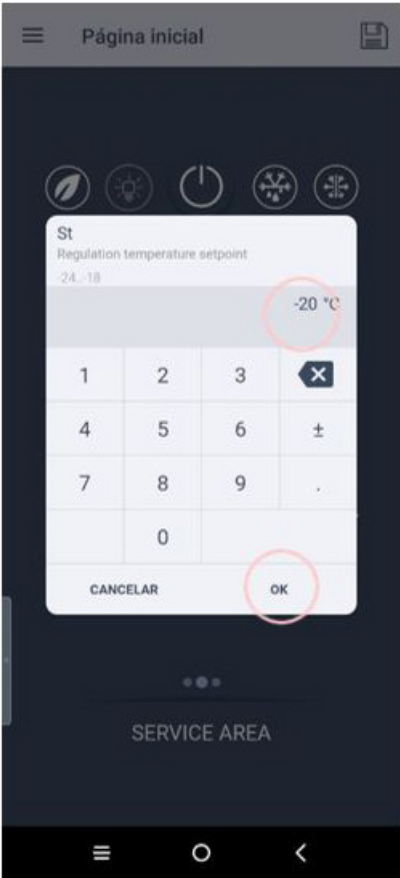
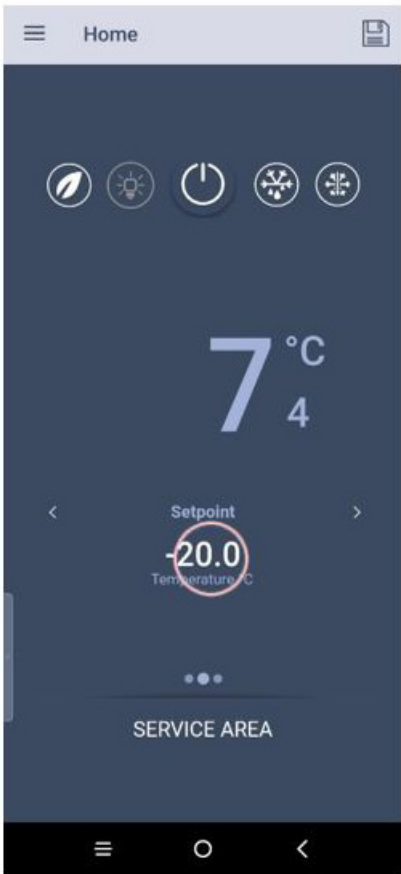

**APPLICA SOFTWARE - SET-POINT ADJUSTMENT (BLUETOOTH)**

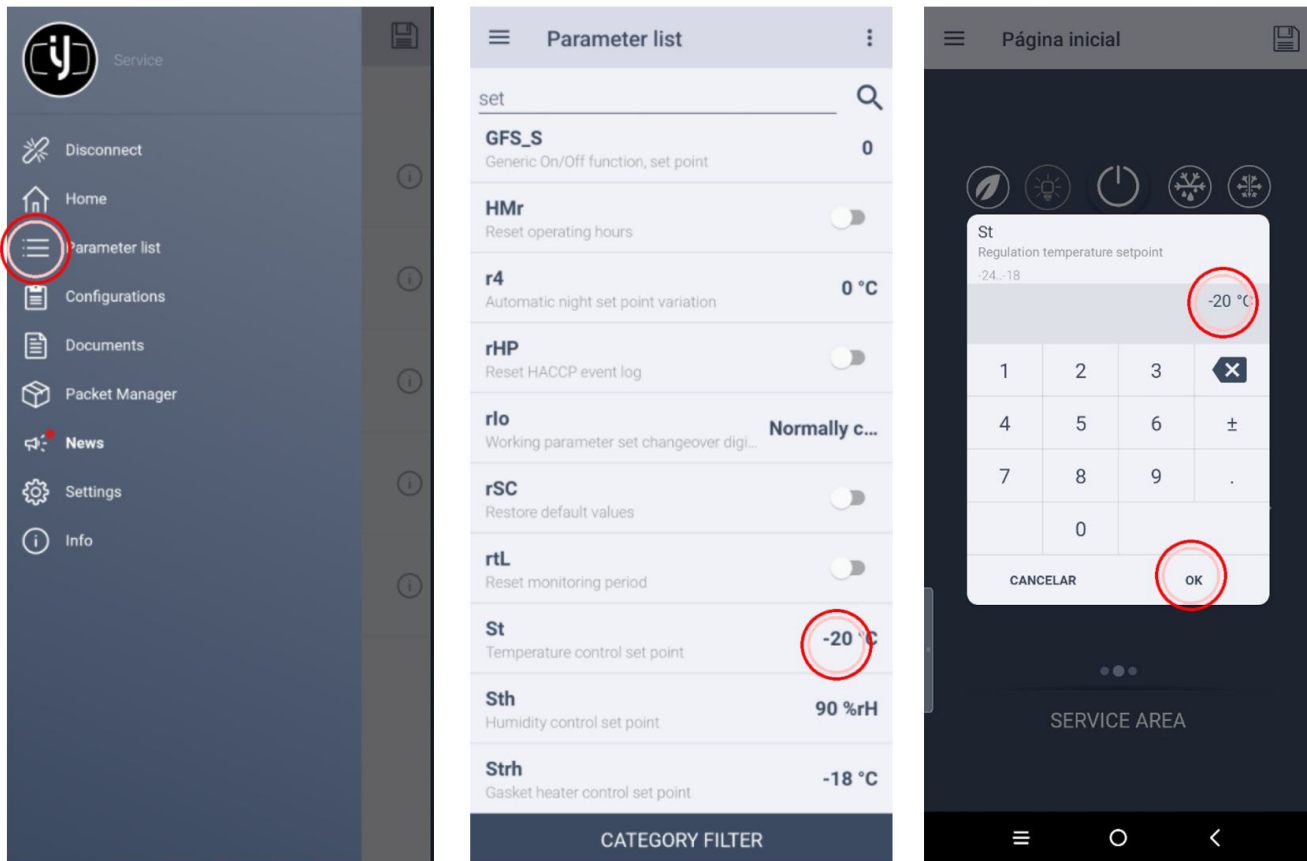

- 1. Press SETPOINT
- 2. Introduce the new value
- 3. Press OK

## APPLICA SOFTWARE - SET-POINT ADJUSTMENT (NFC)



1. Press 
2. Press PARAMETER LIST
3. Find and select ST
4. Introduce new value
5. Select OK

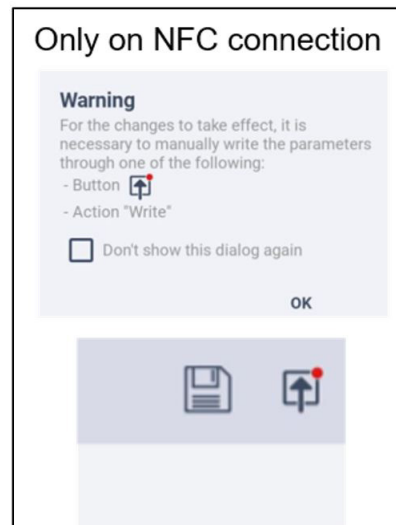

APPLICA SOFTWARE - LIGHT SCHEDULE ADJUSTMENT

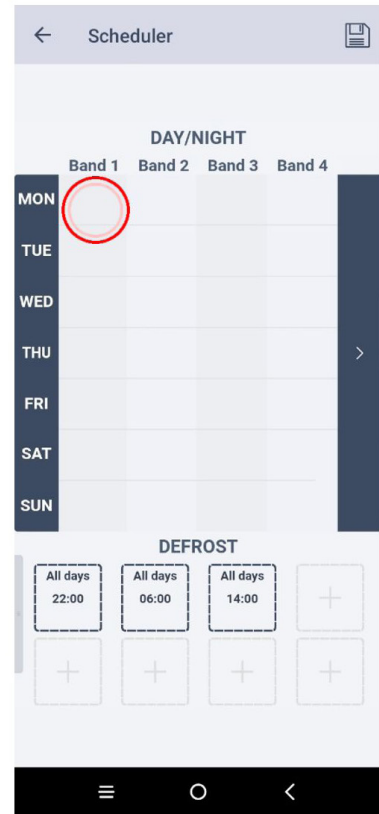
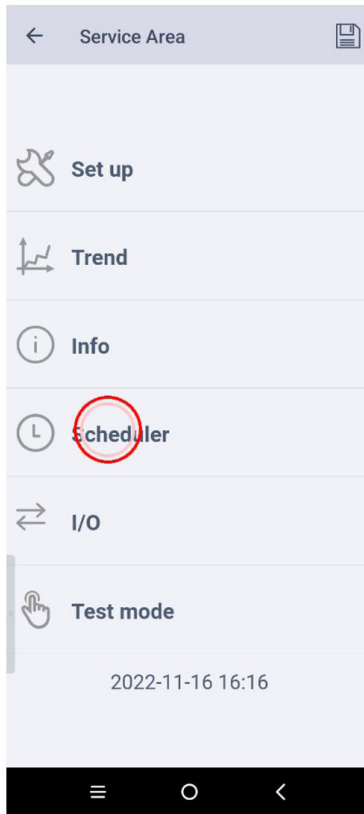
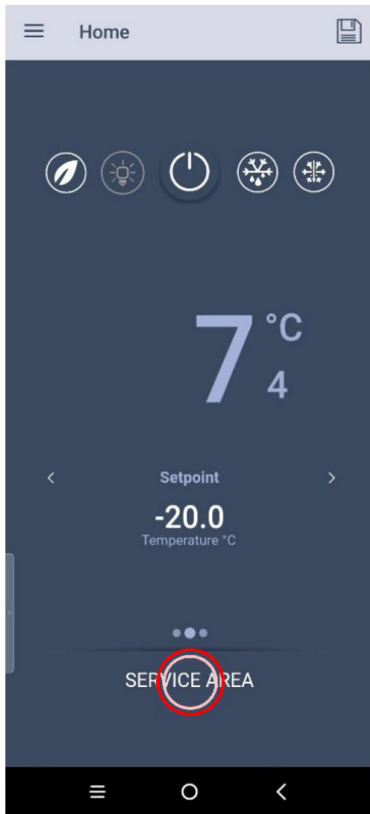

Only on bluetooth connection

1. Press SERVICE AREA

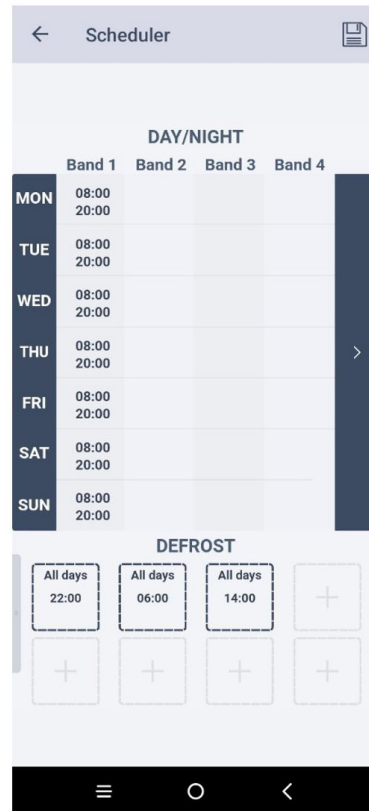
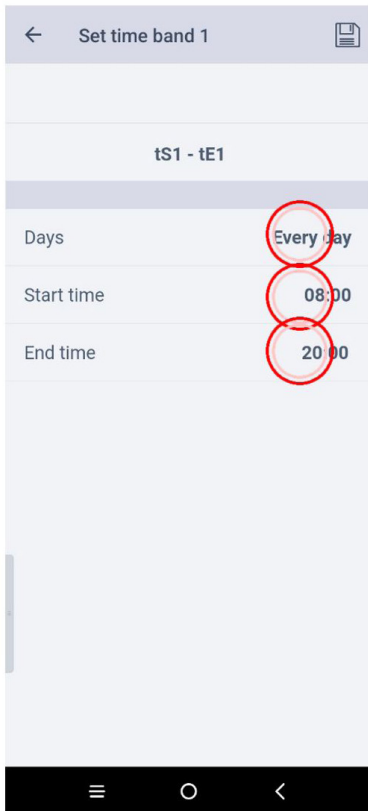

2. Press SCHEDULER

3. Press BAND 1

4. Introduce new values

5. Check schedule

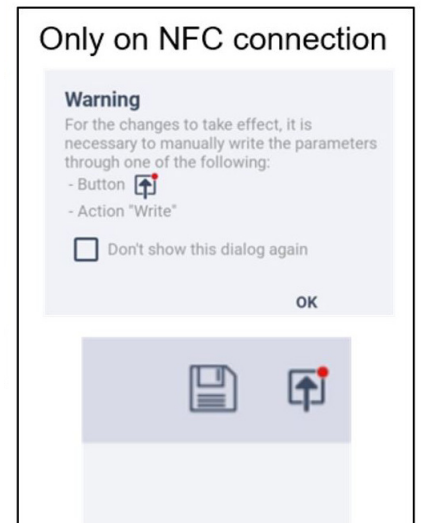

APPLICA SOFTWARE - DEFROST SCHEDULE ADJUSTMENT

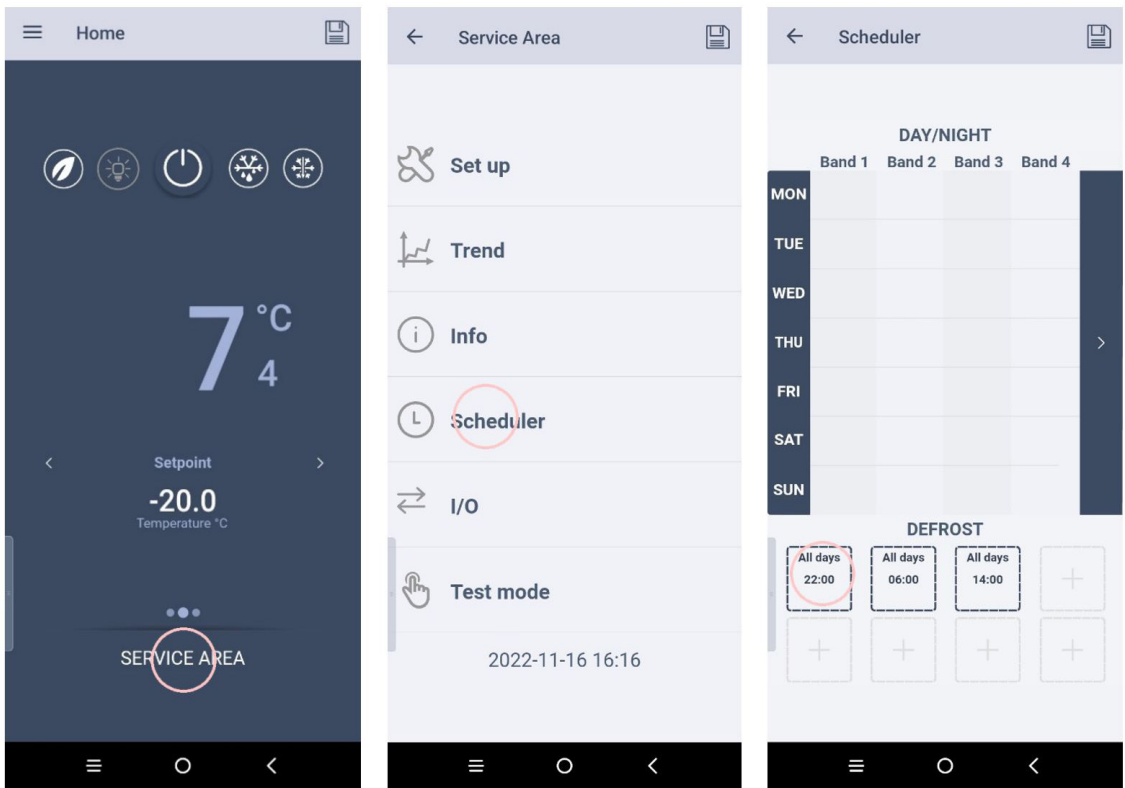

Only on bluetooth connection

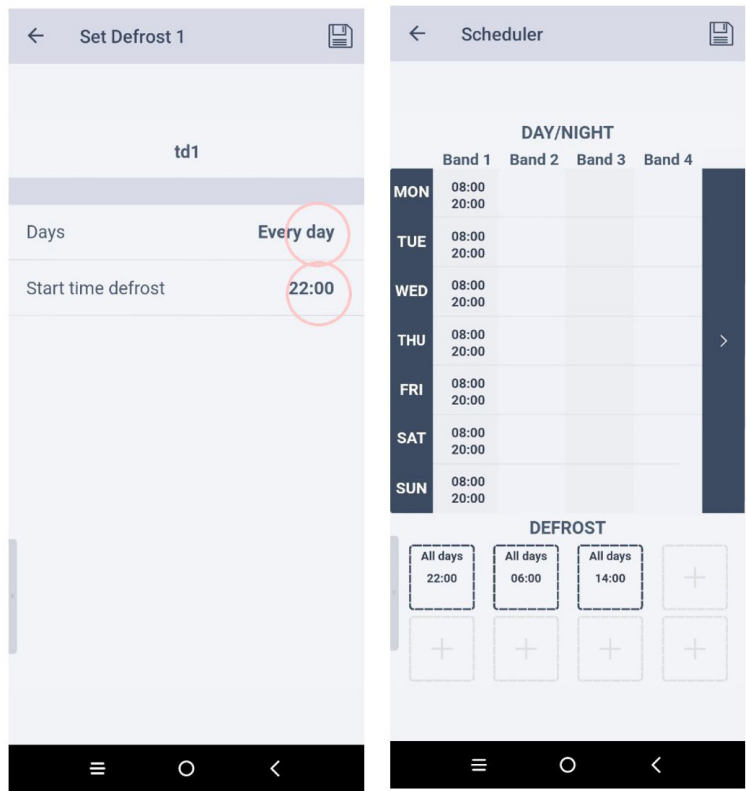

1. Press SERVICE AREA (only Bluetooth)
2. Press SCHEDULER
3. Press + ON DEFROST
4. Introduce new values
5. Check schedule

**Only on NFC connection**

**Warning**  
For the changes to take effect, it is necessary to manually write the parameters through one of the following:

- Button
- Action "Write"

Don't show this dialog again

OK



APPLICA SOFTWARE - Change between freezer & chiller parameters

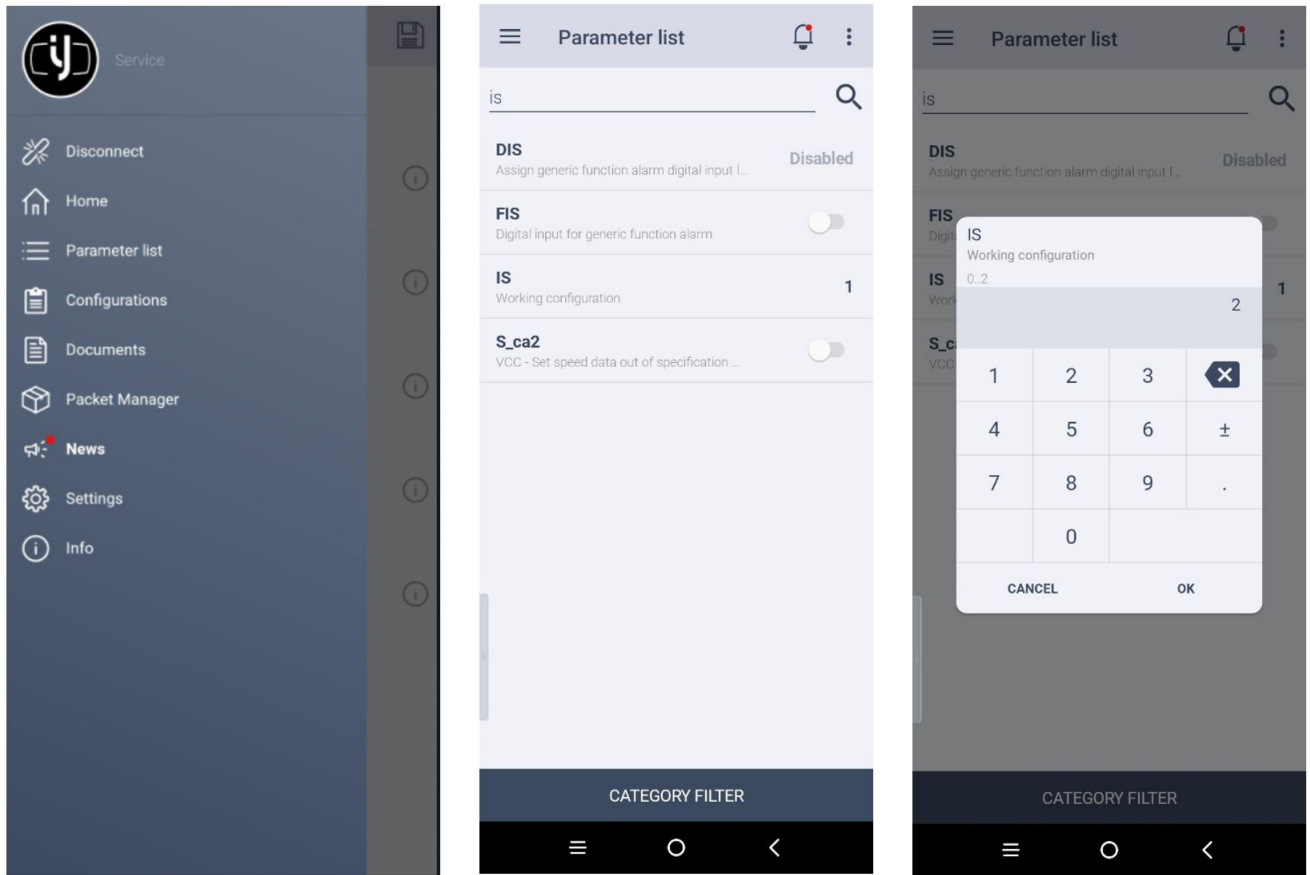

1. Press 
2. Press PARAMETER LIST
3. Find and select “is”
4. Introduce new values
5. Select OK

- 1 - FREEZER
- 2 - CHILLER

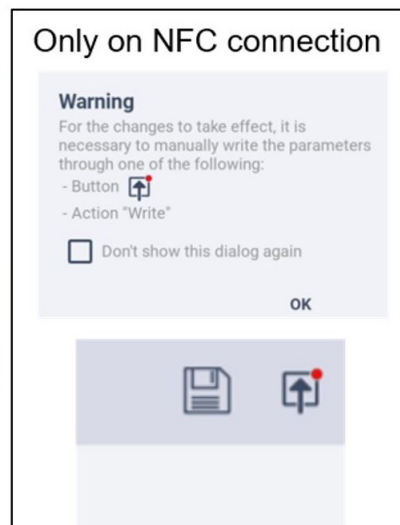

## LOAD LIMITS

Each merchandiser has a load limit decal around the perimeter of the interior. Make sure product is loaded below limit so that refrigeration performance and storage temperature is not disrupted. Shelf life of perishables will be short if load limit is violated.

**AT NO TIME SHOULD MERCHANDISERS BE STOCKED BEYOND THE LOAD LIMITS INDICATED.**



## STOCKING

Product should **NOT** be placed inside the case until case is at proper operating temperature.

**Allow merchandiser 24 hours to operate before loading product. Verify case pulls down to setpoint temperature.**

These cases come with lids. The lids are necessary for the case to operate properly and keep the correct temperature. They should only be opened to place and remove products. They must be closed immediately afterwards.

Use gloves to protect the hands when loading frozen products. Proper rotation of product during stocking is necessary to prevent product loss. Always bring the oldest product to the top and set the newest to the bottom.

The wall and floor racks should always be installed in the case. The racks must be used to prevent products from touching the edges of the case thawing when the case is in defrost mode.



## MAINTENANCE

### **WARNING**

**Disconnect electrical power before servicing. Unplug the unit from the socket.**

### CARE AND CLEANING

Long life and satisfactory performance of any equipment is dependent upon the care it receives. To ensure long life, proper sanitation and minimum maintenance costs, these merchandisers should be completely defrosted semi-annually. Ice accumulation is a normal phenomenon. The quantity and speed in which ice accumulates depend on environmental conditions and the frequency in which the lids are opened.

#### Exterior Surfaces

The exterior surfaces and the exterior lids must be cleaned with a mild detergent and warm water to protect and maintain their attractive finish. **NEVER USE ABRASIVE CLEANSERS, ABRASIVE MATERIALS OR SCOURING PADS.**

#### Interior Surfaces

The interior surfaces may be cleaned with most domestic detergents, ammonia based cleaners and sanitizing solutions with no harm to the surface. The inner part of the lids can only be cleaned with a soft cloth soaked with a solution of 90% distilled water and 10% isopropyl alcohol. Cleaning products can destroy the covering.

### **WARNING**

**Product will be degraded and may spoil if allowed to sit in a non-refrigerated area. Do NOT allow cleaning agent or cloth to contact food product.**

### *Do NOT USE:*

- Abrasive cleansers and scouring pads, as these will mar the finish.
- Coarse paper towels on coated glass.
- Ammonia-based cleaners on acrylic parts.
- Solvent, oil or acidic based cleaners on any interior surfaces.
- Do not use high pressure water hoses.
- Remove fixed parts for cleaning.
- Heaters or sharp objects for defrosting.
- Do NOT flood merchandiser with water.

**NEVER INTRODUCE WATER FASTER THAN THE WASTE OUTLET CAN REMOVE IT.**

### **WARNING**

**Do NOT use HOT water on Cold glass Surfaces. This can cause the glass to shatter and could result in personal injury. Allow glass fronts, to warm before applying hot water.**

### **WARNING**

**Do not use mechanical devices or other means to accelerate the defrosting process, other than those recommended by the manufacturer.**

**Do not use electrical appliances inside the food storage compartments of the case(s), unless they are of the type recommended by the manufacturer.**

**Do:**

- Remove the product and all loose debris to avoid clogging the waste outlet.
- Store product in a refrigerated area such as a cooler. Remove only as much product as can be taken to the cooler in a timely manner.
- Thoroughly clean all surfaces with soap and hot water. **DO NOT USE STEAM OR HIGH WATER PRESSURE HOSES TO WASH THE INTERIOR. THESE WILL DESTROY THE MERCHANTISERS' SEALING CAUSING LEAKS AND POOR PERFORMANCE.**
- Clean and dry equipment with a soft cloth. Allow merchandisers to dry before resuming operation.
- After cleaning is completed, turn on power to the merchandiser. Allow case to reach operational temperature before stocking with product.

**REMOVING SCRATCHES FROM BUMPER**

Most scratches and dings can be removed using the following procedure.

1. Use steel wool to smooth out the surface area of the bumper.
2. Clean area.
3. Apply vinyl or car wax and polish surface for a smooth glossy finish.

**CLEANING CONDENSER**

The condensing unit area may be cleaned with a vacuum using a wand attachment to suck up dirt and debris. It should be cleaned at minimum of twice a year. While cleaning, be careful not to bend any tube or disconnect electrical wires. A dirty condenser blocks normal airflow through the coils, which increases energy consumption and reduces performance.

**NEVER USE SHARP OBJECTS AROUND COILS. Do not puncture coils!** Do not bend fins. Contact an authorized service technician if a coil is punctured, cracked, or otherwise damaged. **ICE** in or on the coil indicates the refrigeration and defrost cycle is not operating properly. Contact an authorized service technician to determine the cause of icing, and to make adjustments as necessary. To maintain product integrity, move all product to a cooler until the unit has returned to normal operating temperatures.

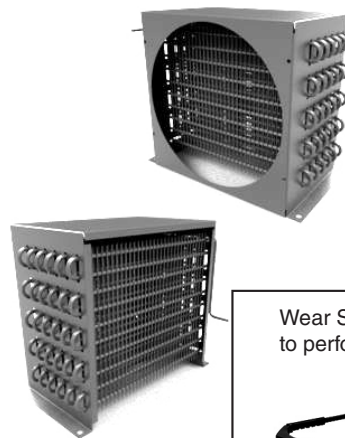

Wear Safety Glasses and Gloves to perform this maintenance.

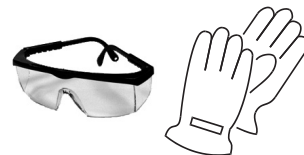

### CLEANING GLASS LIDS

Cleaning with cloth with abrasive microfibers and all types of coarse sponges is prohibited.

Make sure that large quantities of water are not applied on the glass surfaces to be cleaned and that the surfaces are thoroughly dry afterward.



## CAUTION

The inner part of the lids can only be cleaned with a soft cotton cloth soaked with a solution: of 90% distilled water and 10% isopropyl alcohol. Cleaning products can destroy the covering. The outer parts of the lids can be cleaned with normal cleaning products.

### CLEANING THE DEFROST CHANNEL

Drench a piece of cloth with a non-reactive cleaning product to cleanse the defrost channel.



A paint brush is recommended to clean the defrost channel corners.



### CONDENSATE PAN CLEANING

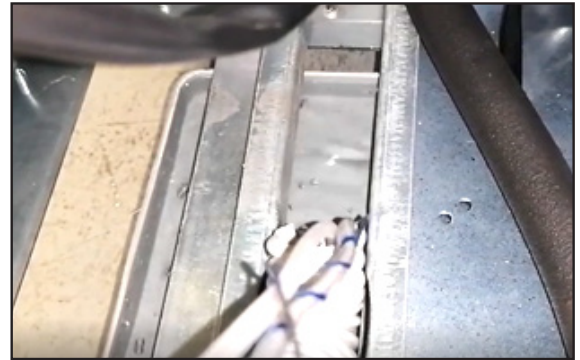

Top View of Drain Piping

Remove the condensate pan as shown in the photos below.



Condensate Pan Installed



Condensate Pan Removed

After cleaning, reinstall the condensate pan.

Do not use abrasive materials or mops as they will definitively damage the merchandiser's surface. Do not remove fixed parts for cleaning. If necessary, they must be cleaned by qualified personnel. If any component is damaged, it must be replaced by an individual qualified for this task.

Self-Contained Refrigeration Equipment Maintenance Check List

\*\*\*\*\* Warranty does not cover issues caused by improper installation or lack of basic preventative maintenance. \*\*\*\*\*

Record starting date	
Store Name and Number	
Store Address	
Unit Model Number	
Unit Serial Number	
Contractor/Technician	

PM activity-For visual inspection items, denote "ok or complete" in the column to right when PM has been performed. For measured data requested, record data requested in the appropriate column to the right)	Technician										
	Quarterly	Semi-Annually	Q1	Q2	Q3	Q4	Q1	Q2	Q3	Q4	
Check in with store manager, record any complaints or issues they have with unit.	X										
Look unit over for any damage, vibrations or abnormal noise.	X										
Verify unit is level side to side and front to rear.	X										
Confirm refrigerant lines properly are secured and not touching or rubbing other lines, wires or frame work.	X										
Verify fan motors and motor mounts are tight.	X										
Confirm fan blade/s are tight and not rubbing or hitting.	X										
Make sure all electrical connections, factory and field, are tight.	X										
Verify electrical connections at lamps are they secure and dry.	X										
Check for and replace any frayed or chaffed wiring.	X										
Check all electrical wiring make sure it is secured and not on any sharp edges or hot lines.	X										
Check for air disturbances external to the unit. Heat and air registers, fans, and doors etc.	X										
Check for water leaks.	X										
Clean evaporator coil/s and fan blade/s. Do not use an acid base cleaner. Rinse off any cleaner residue.		X									
Clean discharge air honeycombs or grilles. Do not use an acid base cleaner. Rinse off any cleaner residue.		X									
Clean condenser coil/s and fan blade/s. Do not use an acid base Cleaner. Rinse off any cleaner residue.		X									
Clean condensate drain pan and drain line.		X									
Verify condensate drain lines are clear and functioning.		X									
Record voltage reading at unit with unit off?		X									
Verify condenser and evaporator fans are working.	X										
Record condenser air inlet temperature	X										
Record condenser air outlet temperature	X										
Is condenser air inlet or air exhaust restricted or recirculating?	X										
Verify there are no visual oil or refrigerant leaks.	X										
Record voltage reading with unit running.		X									
Record compressor amp draw.		X									
Record defrost heater voltage and amp draw.		X									
Record anti-sweat heater voltage and amp draw.		X									
Record case product temperature.	X										
Record unit discharge air temperature.	X										
Record unit return air temperature.	X										
Record ambient conditions around unit (wet Bulb temperature and dry bulb temperature).	X										
Check product loading, do not load beyond the units load limits.	X										
Verify clearances on sides/back of unit.	X										
Check unit controller for proper operation. See controller or 1/0 Manual for proper controller operation.		X									
Confirm door switches function.	X										
Verify unit doors and lids work and are sealed correctly.	X										
Verify that all the panels, shields and covers are in place.	X										

Technician Notes:

## SERVICE

### INVERTER

The Inverter has two diagnostics methods, by visual light emission using a LED indication, or by serial communication protocol.

1. Serial Communication
2. Frequency input
3. Drop in
4. AC input (L+N)
5. AC Fan
6. EMI Earth Cable

LED Status	Period	Color	Description
1 Flash	30 seconds	Green 	Normal operation
2 Flashes	5 seconds	Green 	Communication problem
3 Flashes	5 seconds	Red 	Inverter problem
4 Flashes	5 seconds	Orange 	Compressor problem
No Flash	-	-	No input power / Damaged inverter

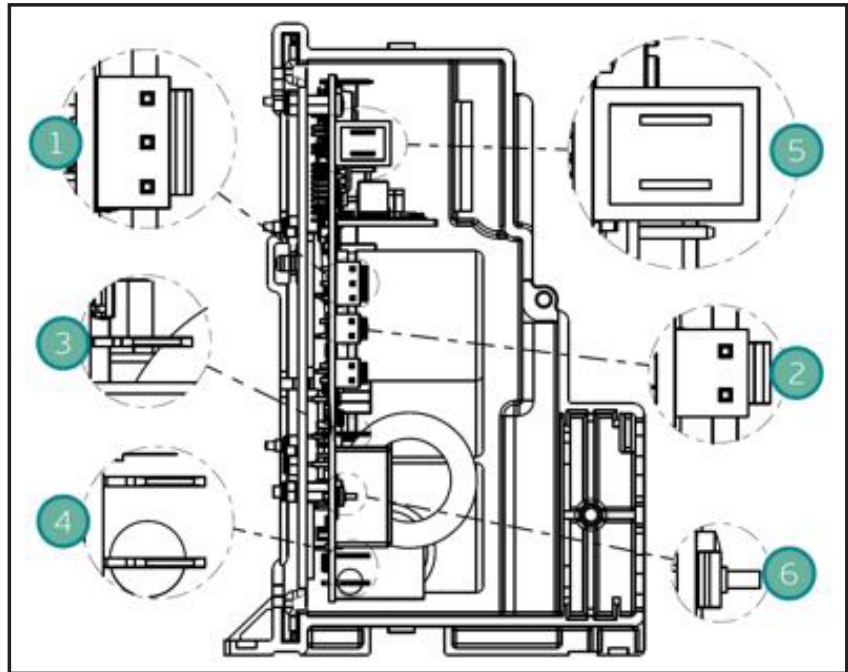

## WARNING

— LOCK OUT / TAG OUT —

*To avoid serious injury or death from electrical shock, always disconnect the electrical power at the main disconnect when servicing or replacing any electrical component. This includes, but is not limited to, such items as doors, lights, fans, heaters, and thermostats.*

**SENSOR REPLACEMENT**

1. Disconnect the probe on the controller
2. Remove from the holder, and pull the cable.
3. Pass the new probe.
4. Connect to controller

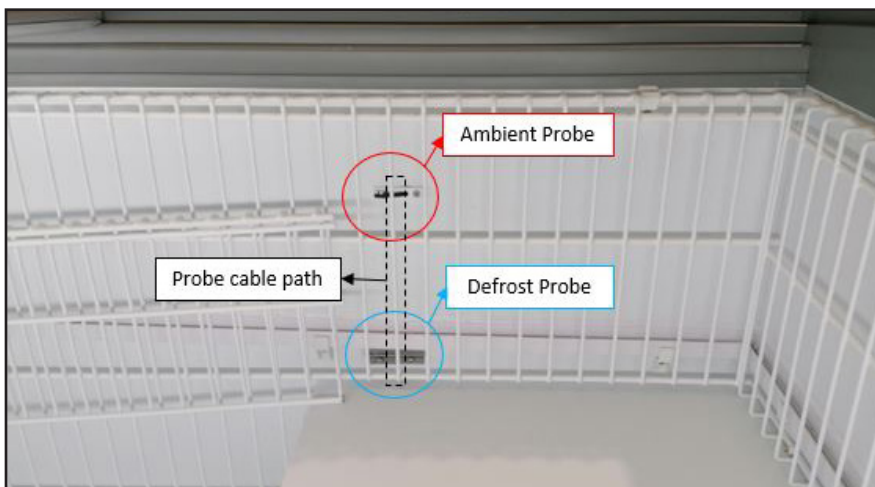
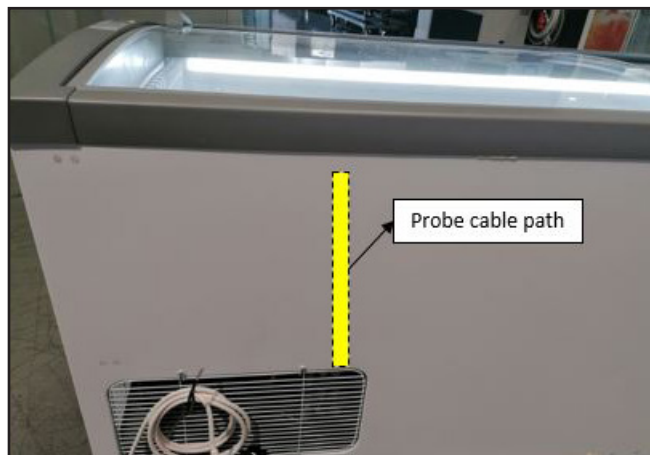

**FAN MOTOR**



Type	NiQ3212-330450-V48.12-193
Field of application	Motor for axial blowers in refrigerating appliances
Electrical rating	100-240 V AC 50/60 Hz max. 25 W 425 mA
Speed	1550 rpm
Inrush current	20 A
Direction of rotation	Counter-Clockwise

EBM NiQ3212

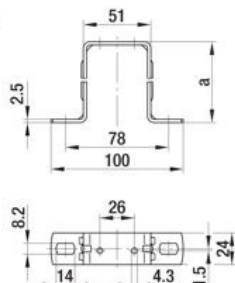

Feet a=2 53/64" (72mm)

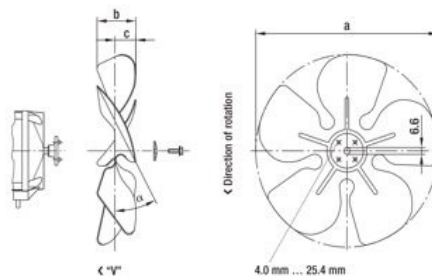

Propeller  $\varnothing$ 7 7/8" (200mm)  $\angle$ 28°



### COMPRESSOR

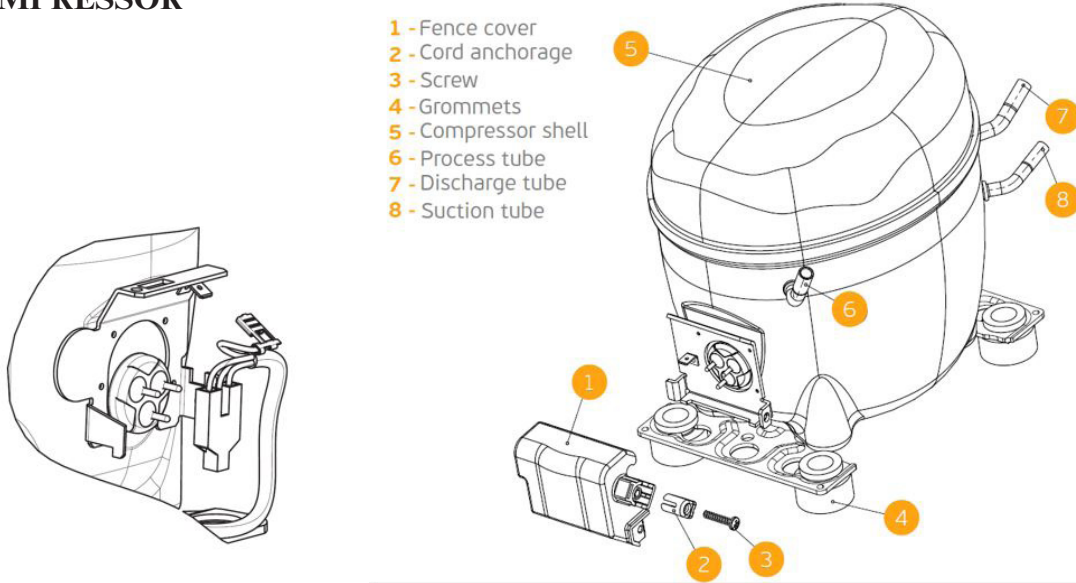

### REPLACING GASKETS

The gaskets is held in place with clips. Remove the clips to pull out the gasket. The lower lid middle gasket is glued to the lid.

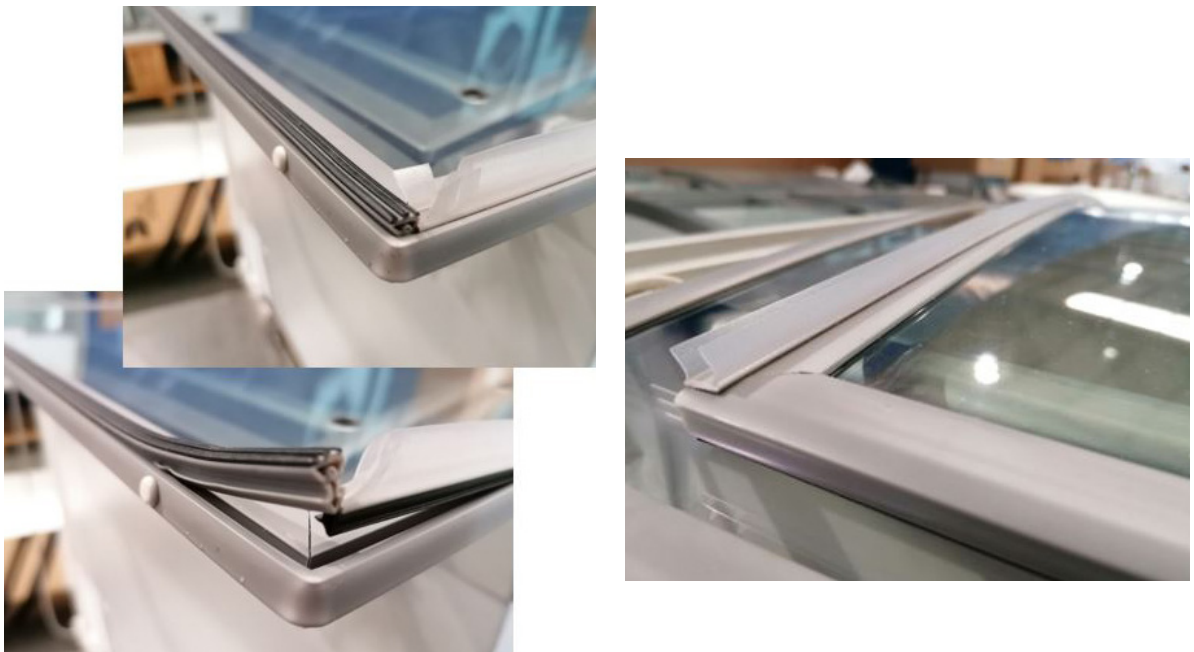

## REPLACING LED LIGHTING

### To remove the front LED bar:

1. Disconnect connector (compressor zone).
2. Remove cover.
3. Remove the LED bar from the metal brackets.
4. Remove the Cable.

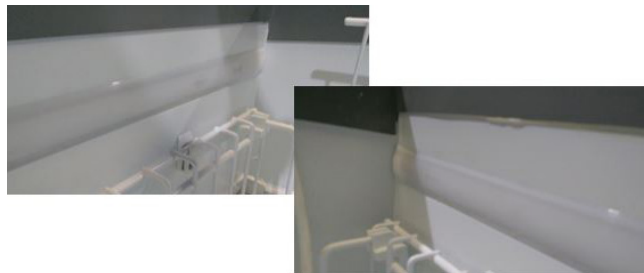

### To replace the front LED bar:

1. Insert cable on in the pipe
2. Fix the LED bar to the metal brackets
3. Fix the diffuser
4. Connect cable to power driver

### To remove the rear LED bar:

1. Disconnect connector (compressor zone).
2. Remove LED bar from plastic profile.
3. Remove Cable.



### To replace the rear LED bar:

1. Insert cable on in the pipe.
2. Fix LED bar to plastic profile.
3. Connect cable to power drive.

## REPLACING DRAIN HEATER

1. Remove product and wire shelves.
2. Disconnect heater from the connection box.
3. Remove the rail, and separate the aluminum from the plastic profile.
4. Replace with new heater.

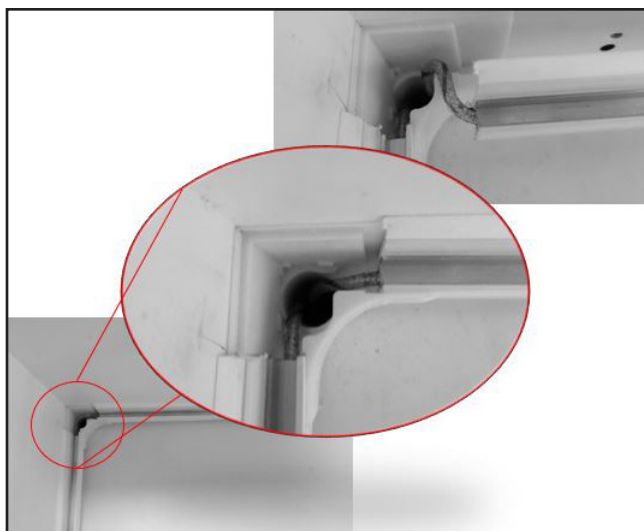
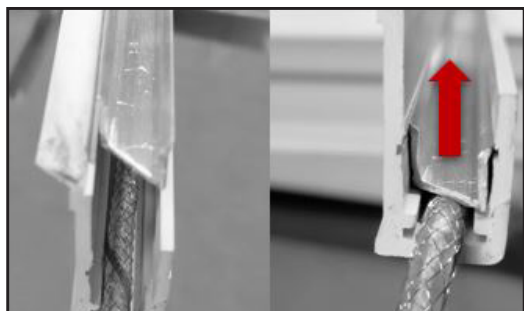

### REPLACING LID HANDLES

Handles are held in place by two screws and plastic rings. Contact your Hussmann representative to obtain replacement parts.

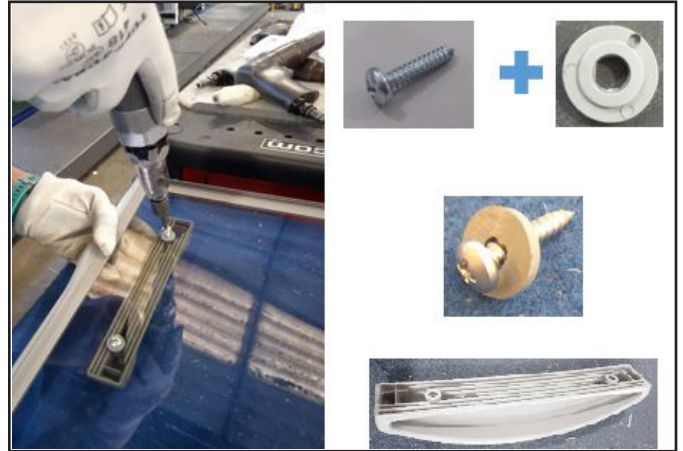

### REPLACING BUMPERS

The bumper is attached by a holder screwed to the cabinet. To replace it, pull it out and then place the new one using a rolling movement.

The bumper ends are attached with screws.



**CASE PROBLEM / RESOLUTION GUIDE**

Use the following as a checklist for discovering and correcting problems with the operation of this case.

- Check if there is an electric current.
- Check if the plug is properly inserted in the source outlet and if the voltage and frequency are appropriate for operation.

**Unsatisfactory case temperature:**

- Check that the unit has been running long enough to have reached desired temperature.
- Check that the appliance is not near an air current or a heat source.
- Check that the lids are closing properly.
- Check the temperature regulation.
- Check that the products stocked in the case do not exceed the indicated load limit.
- Check if the room and defrosting probe thermostats are turned on correctly.
- Check that the condenser fan and the condenser is operating and are unobstructed.

**Very noisy equipment**

- Check that the appliance is placed on an even surface.
- Check that vents are unobstructed.
- Check if the screws and nuts are perfectly secure.
- Check if the cooling fan has any problems or does not operate properly.
- Check if the compressor has any problems or does not operate properly.
- Check if any of the condenser's support parts are loose or broken.

**LED lighting does not operate:**

- Check if lighting has power.
- Check if lighting was turned off by timer (Care Control Panel).

**CASE PROBLEM / RESOLUTION GUIDE**

Use the following as a checklist for discovering and correcting problems with the operation of this case.

**Lots of ice on equipment walls**

- Check if the AD equipment executes automatic defrosting.
- Check if the lids are sealing correctly.
- Check if the products are touching the interior walls.
- Check if the defrost gutter resistance is damaged.
- Check that the products stocked in the case do not exceed the indicated load limit.
- Check if the room and defrosting probe thermostats are turned on correctly.
- Check that local temperature and relative humidity conditions exceed the equipment's climate classification (found on the characteristics label).

**High electric energy consumption**

- Check if the set point is at maximum.
- Check if the condenser is blocked.
- Check if the lids are properly closed.
- Check if the local conditions exceed the equipment's climate classification (found on the characteristics label).
- Check the equipment's ventilation channels (correct distance between objects or if cooling fan motor is operating).

**Condensation inside of case cabinet**

- Check if the set point is at maximum.
- Check if products are over the load limit.
- Check if the glass is dirty or obstructed with adhesives.
- Check if external conditions exceed the limit of the equipment's normal operation.

If none of these situations resolves the issue, please call your Husmann representative.

CASE EXPLODED PART VIEWS  
BNKR1700A

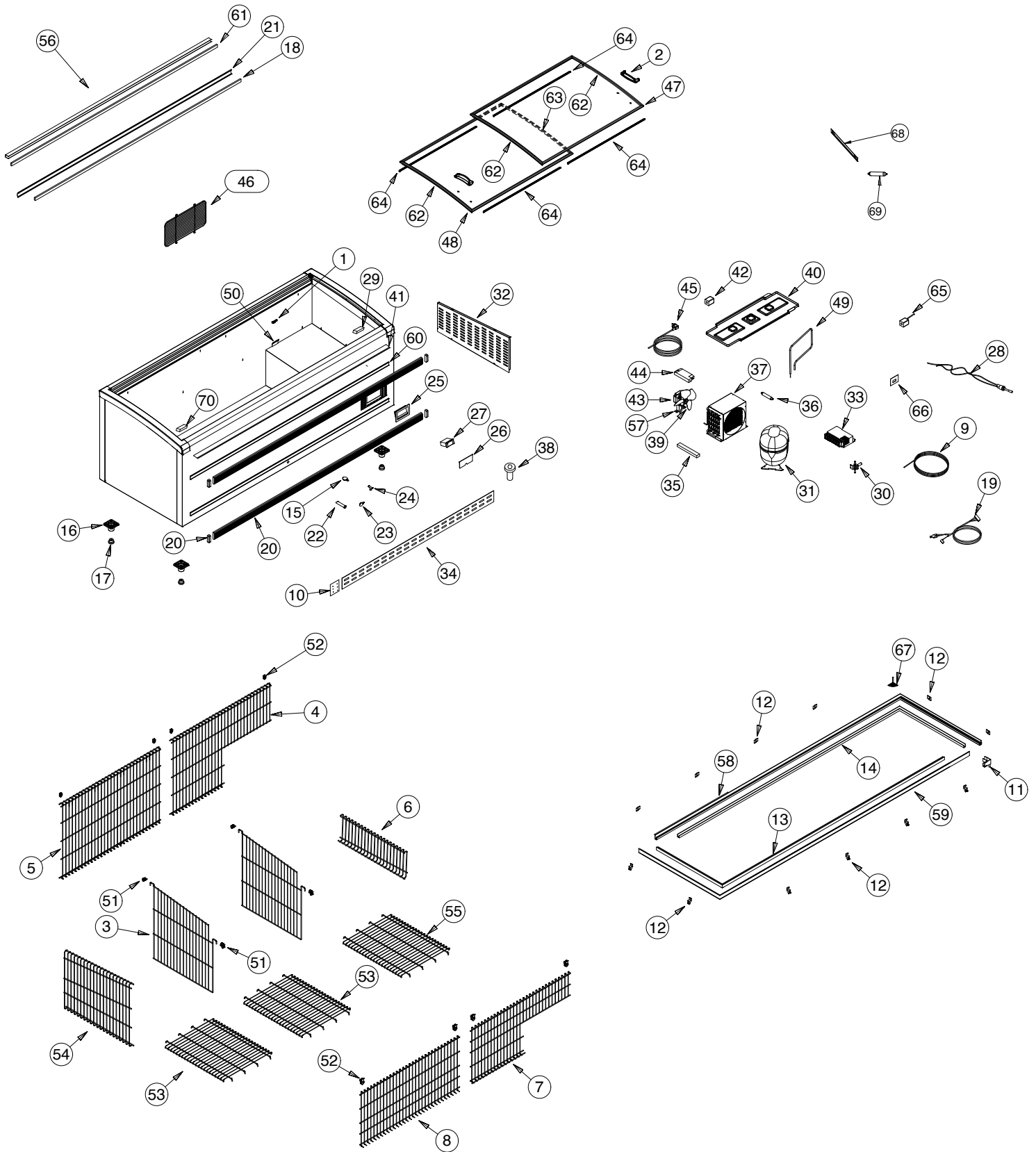

**CASE EXPLODED PARTS  
BNKR1700A**

PARTS LIST			PARTS LIST		
ITEM	PART NUMBER	TITLE	CROSS REF PN	CROSS REF PN	QTY
48a	3123273	GLASS-LID SLIDING GRAY 1700 INFERIOR W HANDLE C0933005	5110825	C0933005	1
48b	3151623	GLASS-LID SLIDING BLACK 1700 INFERIOR W HANDLE C0933109	5110166	C0933109	1
49	3123446	HEATER-DEFROST RESISTANCE 031096	5102228	031096	1
50	3113494	PLATE-SUPPORT DEFROST PROBE 5150008	5120116	5150008	1
51a	3113486	DIVIDER-PLASTIC SUPPORT 5110854	011040	5110854	4
51b	3154680	DIVIDER-GRAY PLASTIC SUPPORT BLK 5110450	030950	5110450	4
52a	3113487	SUPPORT-SHELF PLASTIC WALL 5110851	020638	5110851	8
52b	3154679	SUPPORT-SHELF PLASTIC WALL BLK 5110444	5110936	5110444	8
53a	3113539	SHELF-WIRE 500MM 5130004	510486	5130004	2
53b	3154688	SHELF-WIRE 500MM BLK 5130312	020323	5130312	2
54a	3123225	SUPPORT-SIDE SHELF 5130324	020599	5130324	1
54b	3154700	SUPPORT-SIDE SHELF BLK 5130475	5141592	5130475	1
55a	3113482	SHELF-WIRE 450MM 5130003	5141593	5130003	1
55b	3154689	SHELF-WIRE 450MM BLK 5130313	5142161	5130313	1
56a	3123447	SUPPORT-PVC LED GRAY 1556MM 011243	5141593	011243	1
56b	3151603	SUPPORT-PVC LED BLACK 1556MM 011688	5142161	011688	1
57	3113506	SUPPORT-FAN MOTOR 72MM 090988	020604	090988	1
58a	3123303	CHANNEL-DRAIN SUPERIOR 1553X688MM 011595	5190033	011595	1
58b	3154672	CHANNEL-DRAIN SUPERIOR BLK 1553X688MM 011684	031168	011684	1
59a	3123307	CHANNEL-DRAIN INFERIOR 1520X718MM 011599	020564	011599	1
59b	3154689	CHANNEL-DRAIN INFERIOR BLK 1520X718MM 011659	020577	011659	1
60	3123312	SUPPORT-BUMPER 1640MM 011458	050316	011458	2
61	3123448	LED BAR-DIFFUSED 1500MM 5000K ECO A50C2 031161	020079	031161	1
62	3113543	LID-SEAL PROFILE 10 X 760MM 011227	5120295	011227	3
63	3123325	LID-SEAL PROFILE 9MM 011163	5110703	011163	1
64	3123449	LID-SLIDING PROFILE 795MM C010829	020607	C010829	4
65	3113517	MODULE-COMMUNICATORPZ48500 030572	030221	030572	1
66	3113530	SUPPORT-JOINERS 5150015	5130046	5150015	4
67a	3123302	FILTER-DRAIN CHANNEL 5110283	5130208	5110283	1
67b	3154682	FILTER-DRAIN CHANNEL BLK 5110452	030834	5110452	1
68	3123328	LABEL-CHARGE LEVEL 070006	030221	070006	4
69	3123228	FILTER-DEFROSTING 020643	5130046	020643	1
70a	3123245	STOP-LID LH GRAY 5110937	5130208	5110937	1
70b	3151608	STOP-LID LH BLACK 5110457	5130253	5110457	1

PARTS LIST			PARTS LIST		
ITEM	PART NUMBER	TITLE	CROSS REF PN	CROSS REF PN	QTY
23a	3113457	PLUG-WHITE EXTERIOR DRAIN 5110825	5110825	5110825	1
23b	3151604	PLUG-BLACK EXTERIOR DRAIN 5110166	5102228	5110166	1
23c	3151605	PLUG-GRAY EXTERIOR DRAIN 5110228	5110107	5110228	1
24	3113490	DRAIN-PURGE 5110107	5120116	5110107	1
25a	3123327	PANEL-CONTROL WO SWITCH R7042 5120116	5120301	5120116	1
25b	3151610	PANEL-CONTROL WO SWITCH BLACK 5120301	011040	5120301	1
26	3123324	LID-ACRILIC FOR CONTROL PANEL 135 X 57 MM 011040	030950	011040	1
27	3113449	CONTROLLER-CAREL IR33 VCC 030950	020638	030950	1
28	3129878	SWITCH-HIGH PRESSURE 020638	5110936	020638	1
29a	3123246	STOP-LID RH GRAY 5110936	510486	5110936	1
29b	3151609	STOP-LID RH BLACK 5110456	020323	510486	1
30	3113497	VALVE-025 DEFROST SANHUA 020323	020599	020323	1
31	3113465	COMPRESSOR-EMBRACO FMT413U 115-230V-50-60HZ R290 020599	5141592	020599	1
32a	3123322	PLATE-EXT SIDE WHI GRID 5141592	5141593	5141592	1
32b	3151614	PLATE-EXT SIDE BLK GRID 5141593	5142161	5141593	1
32c	3151616	PLATE-EXT SIDE LIGHT GRAY GRID 5142160	5190033	5142161	1
32d	3151617	PLATE-EXT SIDE DARK GRAY GRID 5142161	031168	5142161	1
33	3113463	INVERTER-FMFT COMPRESSOR FREQUENCY 020604	020564	020604	1
34	3123444	KICK PLATE-FRONT 1700 5190033	020577	5190033	1
35	3113379	TRANSFORMER-LED BAR 60W 2X800MM AS0C2 031168	050316	031168	1
36	3113464	FILTER-7.5G-IN-6-OUT-3 020564	020079	020564	1
37	3113468	CONDENSER-WIRE ON TUBE 020577	5120295	020577	1
38	3114522	SCREW-KICK PLATE 050316	020079	050316	4
39	3113469	FAN BLADE-ASPRANT TUBE HELIX DIA200MM 28DEC 020079	5120295	020079	1
40	3123329	TRAY-WATER 5120295	5110703	5120295	1
41	3123445	PRICE TAG-HOLDER 1545MM 5110703	020607	5110703	1
42	3113498	VALVE-L2W 115V SOLENOID DEFROST SANHUA 020607	030834	020607	1
43	3113470	MOTOR-FAN HIGH EFFICIENCY NQ 020602	030221	020602	1
44	3113462	BOX-CONNECTOR 030834	5130046	030834	1
45	3113454	CABLE-POWER 3G14AWG TYPE-B NEMA 5-15P 030221	5130253	030221	1
46a	3113491	GRID-WIRE RECTANGULAR WHITE EXTERIOR 430X220MM 5130046	5130208	5130046	1
46b	3151611	GRID-WIRE RECTANGULAR BLACK EXTERIOR 430X220MM 5130208	5130208	5130208	1
46c	3151612	GRID-WIRE RECTANGULAR GRAY EXTERIOR 430X220MM 5130253	5130253	5130253	1
47a	3123277	GLASS-LID SLIDING GRAY 1700 SUPERIOR W HANDLE C093006	C093006	C093006	1
47b	3151624	GLASS-LID SLIDING BLACK 1700 SUPERIOR W HANDLE C093110	C093110	C093110	1

PARTS LIST			PARTS LIST		
ITEM	PART NUMBER	TITLE	CROSS REF PN	CROSS REF PN	QTY
1a	3113477	SUPPORT-PROBE PLASTIC BLK 5111259	5110259	5111259	1
1b	3154678	SUPPORT-PROBE PLASTIC BLK 5110343	5110343	5110343	1
2a	3113374	HANDLE-200MM SLIDING LD RAL7042 W SCREWS C5110549	C5110549	C5110549	2
2b	3151629	HANDLE-200MM SLIDING LD BLACK W SCREWS C5110887	C5110887	C5110887	2
3a	3113519	DIVIDER-BIG W SUPPORT C5130071	C5130071	C5130071	2
3b	3154703	DIVIDER-BIG W SUPPORT BLK C5130307	C5130307	C5130307	2
4a	3113520	SUPPORT-SHELF BACK STEP SIDE 5130014	5130014	5130014	1
4b	3154686	SUPPORT-SHELF BACK STEP SIDE BLK 5130310	5130310	5130310	1
5a	3123441	SUPPORT-BACK SHELF 5130023	5130023	5130023	1
5b	3154688	SUPPORT-BACK SHELF BLK 5130434	5130434	5130434	1
6a	3123226	SUPPORT-STEP SIDE SHELF 5130325	5130325	5130325	1
6b	3154699	SUPPORT-STEP SIDE SHELF BLK 5130474	5130474	5130474	1
7a	3113524	SUPPORT-SHELF FRONT STEP SIDE 5130013	5130013	5130013	1
7b	3154687	SUPPORT-SHELF FRONT STEP SIDE BLK 5130311	5130311	5130311	1
8a	3123442	SUPPORT-FRONT SHELF 5130017	5130017	5130017	1
8b	3154697	SUPPORT-FRONT SHELF BLK 5130433	5130433	5130433	1
9	3113476	PROBE-NITCO15HPD0 15M 030499	030499	030499	2
10	3114521	KICK PLATE-JOIN W SCREWS C5190036	C5190036	C5190036	1
11a	3114524	CORNER-DEFROST W HOLE 5110220	5110220	5110220	1
11b	3154683	CORNER-DEFROST W HOLE BLK 5110864	5110864	5110864	1
12a	3113500	SUPPORT-DRAIN CHANNEL-EVAPORATOR 5110971	5110971	5110971	18
12b	3154681	SUPPORT-DRAIN CHANNEL-EVAPORATOR BLK 5110451	5110451	5110451	18
13	3123241	CHANNEL-ALUMINIUM INFERIOR 1525X707MM C5150821	C5150821	C5150821	1
14	3123227	CHANNEL-ALUMINIUM SUPERIOR 1545X687MM C5150822	C5150822	C5150822	1
15a	3113488	PLUG-INTERIOR DRAIN 5110105	5110105	5110105	1
15b	3154677	PLUG-INTERIOR DRAIN BLK 5110204	5110204	5110204	1
16	3113473	LEG-85MM WITH LEVELER C5110220	C5110220	C5110220	4
17	3113445	LEVELER-M12 X 50MM 5110017	5110017	5110017	4
18	3123443	LED BAR-1500MM 5000K ECO A50C2 031160	031160	031160	1
19	3128218	CABLE-FMFT INVERTER 031183	031183	031183	1
20a	3123247	BUMPER KIT RAL7016 I PER CASE C011509	C011509	C011509	1
20b	3128219	BUMPER KIT BLACK I PER CASE C011054	C011054	C011054	1
21	3123317	DIFUSER-LIGHT 1552MM 5110566	5110566	5110566	1
22a	3113489	PIPE-WHITE DRAIN 5110347	5110347	5110347	1
22b	3151606	PIPE-BLACK DRAIN 5110348	5110348	5110348	1
22c	3151607	PIPE-GRAY DRAIN 5110349	5110349	5110349	1

CASE EXPLODED PART VIEWS  
BNKR1940EA

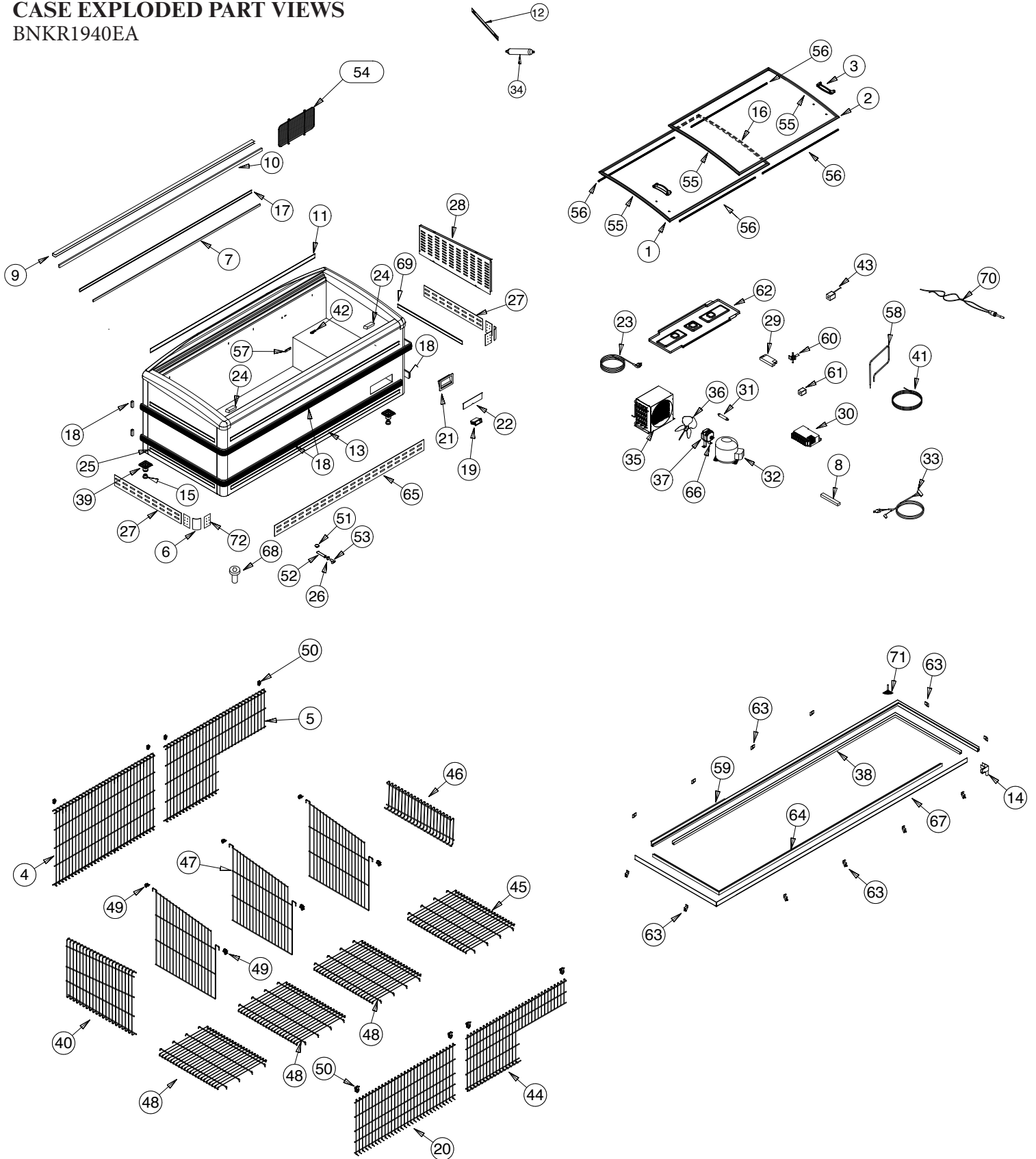



**CASE EXPLODED PARTS  
BNKR1940EA**

PARTS LIST				
ITEM	PART NUMBER	TITLE	CROSS REF PN	QTY
49b	3154680	DIVIDER-PLASTIC SUPPORT BLK 5110450	5110450	6
50a	3113487	SUPPORT-SHELF PLASTIC WALL 5110851	5110851	8
50b	3154679	SUPPORT-SHELF PLASTIC WALL BLK 5110444	5110444	8
51a	3113488	PLUG-INTERIOR DRAIN 5110105	5110105	1
51b	3154677	PLUG-INTERIOR DRAIN BLK 5110204	5110204	1
52a	3154689	PIPE-WHITE DRAIN 5110347	5110347	1
52b	3151606	PIPE-BLACK DRAIN 5110348	5110348	1
52c	3151607	PIPE-GRAY DRAIN 5110349	5110349	1
53	3113490	DRAIN-PURGE 5110107	5110107	1
54a	3113491	GRID-WIRE RECTANGULAR WHITE EXTERIOR 430X220MM 5130046	5130046	1
54b	3151611	GRID-WIRE RECTANGULAR BLACK EXTERIOR 430X220MM 5130208	5130208	1
54c	3151612	GRID-WIRE RECTANGULAR GRAY EXTERIOR 430X220MM 5130253	5130253	1
55	3113512	SEAL-LID PROFILE 13X760MM 011225	011225	3
56	3113513	EXTRUSION-LID PROFILE 910MM C010834	C010834	4
57	3113494	PLATE-SUPPORT DEFROST PROBE 5150008	5150008	1
58	3113495	HEATER-DEFROST RESISTANCE 031097	031097	1
59	3123304	CHANNEL-DRAIN SUPERIOR 175X8672MM 011596	011596	1
59b	3154674	CHANNEL-DRAIN SUPERIOR BLK 1785X672MM 011695	011695	1
60	313497	VALVE-025 DEFROST SANHUA 02.0323	02.0323	1
61	3113498	VALVE-12W 115V SOLENOID DEFROST SANHUA 02.0607	02.0607	1
62	3123329	TRAY-WATER 512.0295	512.0295	1
63a	3113500	SUPPORT-DRAIN CHANNEL-EVAPORATOR 5110971	5110971	20
63b	3154681	SUPPORT-DRAIN CHANNEL-EVAPORATOR BLK 5110451	5110451	20
64	3123242	CHANNEL-AL INFERIOR 1525X707MM END CASE C5150823	C5150823	1
65	3114517	KICK PLATE-FRONT 1940 5190031	5190031	1
66	3113506	SUPPORT-FAN MOTOR 72MM 090988	090988	1
67a	3123308	CHANNEL-DRAIN INFERIOR 1751X707MM 011600	011600	1
67b	3154673	CHANNEL-DRAIN INFERIOR BLK 1751X707MM 011694	011694	1
67c	3114522	SCREW-KICK PLATE 05.0316	05.0316	20
69	3123316	SUPPORT-BUMPER 720MM 011370	011370	1
70	3129878	SWITCH-HIGH PRESSURE 02.0638	02.0638	1
71a	3123302	FILTER-DRAIN CHANNEL 5110283	5110283	1
71b	3154682	FILTER-DRAIN CHANNEL BLK 5110452	5110452	1
72	3114521	KICK PLATE-JOIN W SCREWS C5190036	C5190036	5

PARTS LIST				
ITEM	PART NUMBER	TITLE	CROSS REF PN	QTY
25	3123315	SUPPORT-BUMPER 766MM 011510	011510	3
26a	3113457	PLUG-WHITE EXTERIOR DRAIN 5110825	5110825	1
26b	3151604	PLUG-BLACK EXTERIOR DRAIN 5110166	5110166	1
26c	3151605	PLUG-GRAY EXTERIOR DRAIN 5110228	5110228	1
27	3114520	KICK PLATE-SIDE 5190032	5190032	2
28a	3123323	PLATE-EXT WHIT GRID 1940 5141594	5141594	1
28b	3151615	PLATE-EXT BLK GRID 1940 5142098	5142098	1
28c	3151618	PLATE-EXT LIGHT GRAY 1940 5142162	5142162	1
28d	3151619	PLATE-EXT DARK GRAY 1940 5142163	5142163	1
29	3113462	BOX-CONNECTOR 030834	030834	1
30	3113463	INVERTER-FMT COMPRESSOR FREQUENCY 020604	02.0604	1
31	3113464	FILTER-7.5G IN-6-OUT-3 020564	02.0564	1
32	3113465	COMPRESSOR-EMRACO FMT1413U 115-230V-50-60HZ R290 02.0599	02.0599	1
33	3128218	CABLE-FMFT INVERTER 031183	031183	1
34	3123228	FILTER-DEFROSTING 020643	02.0643	1
35	3113468	CONDENSER-WIRE ON TUBE 02.0577	02.0577	1
36	3113469	FAN BLADE-ASPIRANT TUBE HELIX DIA200MM 28DEG 020079	020079	1
37	3113470	MOTOR-FAN HIGH EFFICIENCY NID 02.0602	02.0602	1
38	3123233	CHANNEL-AL SUPERIOR 1545X687MM END CASE C5150824	C5150824	1
39	3113473	LEG-85MM WITH LEVELER C5110220	C5110220	4
40a	3123223	SUPPORT-SIDE SHELF 5130322	5130322	1
40b	3154702	SUPPORT-SIDE SHELF 1940 BLK 5130491	5130491	1
41	3113476	PROBE-NTC015HP00 L5M 030499	030499	2
42a	313477	SUPPORT-PROBE PLASTIC 5111259	5111259	1
42b	3154678	SUPPORT-PROBE PLASTIC BLK 5110343	5110343	1
43	3113517	MODULE-COMMUNICATION IROPZ48500 03.0572	03.0572	1
44a	3113481	SUPPORT-SHELF FRONT STEP SIDE 5130016	5130016	1
44b	3154693	SUPPORT-SHELF FRONT STEP SIDE 1940 BLK 5130416	5130416	1
45a	3113482	SHELF-WIRE 450MM 5130003	5130003	1
45b	3154689	SHELF-WIRE 450MM BLK 5130313	5130313	1
46a	3123224	SUPPORT-STEP SIDE SHELF 5130323	5130323	1
46b	3154701	SUPPORT-STEP SIDE SHELF 1940 BLK 5130490	5130490	1
47a	3113484	DIVIDER-BIG W SUPPORTS C5130007	C5130007	3
47b	3154704	DIVIDER-BIG W SUPPORTS 1940 BLK C5130414	C5130414	3
48a	3113485	SHELF-WIRE 410MM 5130002	5130002	3
48b	3154682	SHELF-WIRE 410MM 1940 BLK 5130413	5130413	3
49a	3113486	DIVIDER-PLASTIC SUPPORT 5110854	5110854	6

PARTS LIST				
ITEM	PART NUMBER	TITLE	CROSS REF PN	QTY
1a	3123280	GLASS-LID SLIDING GRAY 1940 INFERIOR W HANDLE C093007	C093007	1
1b	3151625	GLASS-LID SLIDING BLACK 1940 INFERIOR W HANDLE C093111	C093111	1
2a	3123286	GLASS-LID SLIDING GRAY 1940 SUPERIOR W HANDLE C093008	C093008	1
2b	3151626	GLASS-LID SLIDING BLACK 1940 SUPERIOR W HANDLE C093112	C093112	1
3a	3113374	HANDLE-200MM SLIDING LID RAL7042 W SCREWS C5110549	C5110549	2
3b	3151629	HANDLE-200MM SLIDING LID BLACK W SCREWS C5110887	C5110887	2
4a	3113375	SHELF-BACK SUPPORT 1940 5130025	5130025	1
4b	3154686	SHELF-BACK SUPPORT 1940 BLK 5130419	5130419	1
5a	3113376	SHELF-BACK STEP SIDE SUPPORT 1940 5130022	5130022	1
5b	3154685	SHELF-BACK STEP SIDE SUPPORT 1940 BLK 5130418	5130418	1
6	3123231	PLATE-KICK ROUND COR ZINC PLATED 5190073	5190073	2
7	3113378	LED BAR-1700MM 5000K ECO AS0C2 031162	031162	1
8	3113379	TRANSFORMER-LED BAR 60W 2X800MM AS0C2 031168	031168	1
9a	3113516	SUPPORT-PVC LED GRAY 1790MM 011229	011229	1
9b	3151602	SUPPORT-PVC LED BLACK 1790MM 011551	011551	1
10	3113515	LED BAR-DIFFUSED 1700MM 5000K ECO AS0C2 031163	031163	1
11	3113383	PRICE TAG-HOLDER 1820MM 1940 5110317	5110317	1
12	3123328	LABEL-CHARGE LEVEL 070006	070006	4
13	3123314	SUPPORT-BUMPER 2045MM 011045	011045	2
14a	3114624	CORNER-DEFROST W HOLE 5110020	5110020	1
14b	3154683	CORNER-DEFROST W HOLE BLK 5110864	5110864	1
15	3113445	LEVELER-M12 X 50MM 5110017	5110017	4
16	3123326	LID-SEAL PROFILE 9MM 011163	011163	1
17	3123318	DIFFUSER-LIGHT 1785MM 5110755	5110755	1
18a	3123247	BUMPER KIT RAL7016 1 PER CASE C011509	C011509	1
18b	3128219	BUMPER KIT BLACK 1 PER CASE C011054	C011054	1
19	3113449	CONTROLLER-CABEL IR33 VCC 03.0950	03.0950	1
20a	3113450	SUPPORT-FRONT SHELF 5130019	5130019	1
20b	3154684	SUPPORT-FRONT SHELF 1940 BLK 5130417	5130417	1
21a	3123327	PANEL-CONTROL W0 SWITCH R7042 5120116	5120116	1
21b	3151610	PANEL-CONTROL W0 SWITCH BLACK 5120301	5120301	1
22	3123324	LID-ACRILIC FOR CONTROL PANEL 135 X 57 MM 011040	011040	1
23	3113454	CABLE-POWER 3G14AWG TYPE-B NEMA 5-15P 03.0221	03.0221	1
24a	3123246	STOP-LID RH GRAY 5110936	5110936	2
24b	3151609	STOP-LID RH BLACK 5110456	5110456	2

CASE EXPLODED PART VIEWS

BNKR2200A

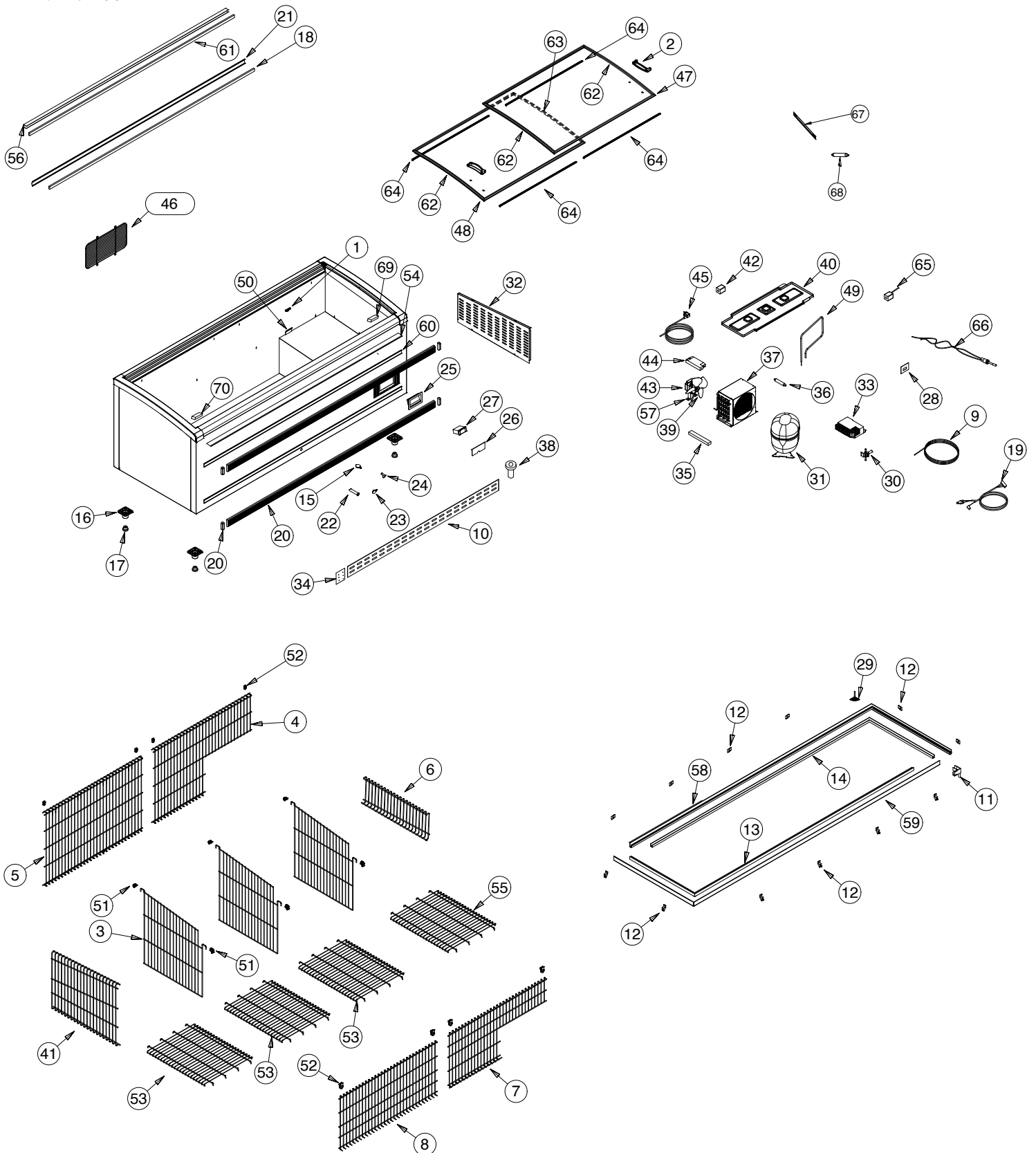

**CASE EXPLODED PARTS  
BNKR2200A**

PARTS LIST			
ITEM	PART NUMBER	TITLE	CROSS REF PN QTY
1a	3113477	SUPPORT-PROBE PLASTIC 511259	511259 1
1b	3154678	SUPPORT-PROBE PLASTIC BLK 5110343	5110343 1
2a	3113374	HANDLE-200MM SLIDING LID RAL7042 W SCREWS C5110549	C5110549 2
2b	3151629	HANDLE-200MM SLIDING LID BLACK W SCREWS C5110887	C5110887 2
3a	3113519	DIVIDER-BIG W SUPPORT C5130071	C5130071 3
3b	3154703	DIVIDER-BIG W SUPPORT BLK C5130307	C5130307 3
4a	3113520	SUPPORT-SHELF BACK STEP SIDE 5130014	5130014 1
4b	3154686	SUPPORT-SHELF BACK STEP SIDE BLK 5130310	5130310 1
5a	3113521	SUPPORT-BACK SHELF 5130026	5130026 1
5b	3154684	SUPPORT-BACK SHELF 2200 BLK 5130308	5130308 1
6a	3123226	SUPPORT-STEP SDE SHELF 5130325	5130325 1
6b	3154689	SUPPORT-STEP SDE SHELF BLK 5130474	5130474 1
7a	3113524	SUPPORT-SHELF FRONT STEP SIDE 5130013	5130013 1
7b	3154687	SUPPORT-SHELF FRONT STEP SIDE BLK 5130311	5130311 1
8a	3154685	SUPPORT-FRONT SHELF 5130020	5130020 1
8b	3154685	SUPPORT-FRONT SHELF 2200 BLK 5130309	5130309 1
9	3113476	PROBE-NTCO15HP00 1.5M 0304099	0304099 2
10	3114518	KICK PLATE-FRONT 2200 5190034	5190034 1
11a	3114524	CORNER-DEFROST W HOLE 5110020	5110020 1
11b	3154683	CORNER-DEFROST W HOLE BLK 5110864	5110864 1
12a	3113500	SUPPORT-DRAIN CHANNEL-EVAPORATOR 5110971	5110971 22
12b	3154681	SUPPORT-DRAIN CHANNEL-EVAPORATOR BLK 5110451	5110451 22
13	3123243	CHANNEL-ALUMINIUM INFERIOR 2025X707MM C5150826	C5150826 1
14	3123229	CHANNEL-ALUMINIUM SUPERIOR 2045X687MM C5150827	C5150827 1
15a	3113488	PLUG-INTERIOR DRAIN 5110105	5110105 1
15b	3154677	PLUG-INTERIOR DRAIN BLK 5110204	5110204 1
16	3113473	LEC-85MM WITH LEVELER C5110220	C5110220 4
17	3113445	LEVELER-M12 X 50MM 5110017	5110017 4
18	3113527	LED BAR-1950MM 5000K ECO AS0C2 031164	031164 1
19	3128218	CABLE-FMFT INVERTER 031183	031183 1
20a	3123247	BUMPER KIT RAL7016 1 PER CASE C011509	C011509 1
20b	3128219	BUMPER KIT BLACK 1 PER CASE C011054	C011054 1
21	3123319	DIFUSER-LIGHT 2052MM 5110569	5110569 1
22a	3113469	PIPE-WHITE DRAIN 5110347	5110347 1
22b	3151606	PIPE-BLACK DRAIN 5110348	5110348 1
22c	3151607	PIPE-GRAY DRAIN 5110349	5110349 1

PARTS LIST			
ITEM	PART NUMBER	TITLE	CROSS REF PN QTY
23a	3113457	PLUG-WHITE EXTERIOR DRAIN 5110825	5110825 1
23b	3151604	PLUG-BLACK EXTERIOR DRAIN 5110166	5110166 1
23c	3151605	PLUG-GRAY EXTERIOR DRAIN 5110228	5110228 1
24	3113490	DRAIN-PURGE 5110107	5110107 1
25a	3123327	PANEL-CONTROL W/O SWITCH R7042 5120116	5120116 1
25b	3151610	PANEL-CONTROL W/O SWITCH BLACK 5120301	5120301 1
26	3123324	LD-ACRLIC FOR CONTROL PANEL 135 X 57 MM 011040	011040 1
27	3113449	CONTROLLER-CAREL IR33 YCC 030950	030950 1
28	3113530	SUPPORT-JOINERS 5150015	5150015 4
29	3123302	FILTER-DRAIN CHANNEL 5110283	5110283 1
30	3113497	VALVE-025 DEFROST SANHUA 020323	020323 1
31	3113465	COMPRESSOR-EMBRACO FMFT4130 115-230V-50-60HZ R290 020599	020599 1
32a	3123322	PLATE-EXT SDE WHIT GRID 5141592	5141592 1
32b	3151614	PLATE-EXT SDE BLK GRD 5141593	5141593 1
32c	3151616	PLATE-EXT SDE LIGHT GRAY GRID 5142160	5142160 1
33	3113463	INVERTER-FMFT COMPRESSOR FREQUENCY 020604	020604 1
34	3114521	KICK PLATE-JOIN W SCREWS C5190036	C5190036 1
35	3113379	TRANSFORMER-LED BAR 60W 2X800MM AS0C2 031168	031168 1
36	3113464	FILTER-7.5G IN-6-OUT-3 020564	020564 1
37	3113468	CONDENSER-WIRE ON TUBE 020577	020577 1
38	3114522	SCREW-KICK PLATE 050316	050316 4
39	3113469	FAN BLADE-ASPIRANT TUBE HELIX DIA200MM 28DEG 020079	020079 1
40	3123329	TRAY-WATER 5120295	5120295 1
41	3123225	SUPPORT-SIDE SHELF 5130324	5130324 1
42	3113488	VALVE-12W 115V SOLENOID DEFROST SANHUA 020607	020607 1
43	3113470	MOTOR-FAN HIGH EFFICIENCY NID 020602	020602 1
44	3113462	BOX-CONNECTOR 030834	030834 1
45	3113454	CABLE-POWER 3G16AWG TYPE-B NEMA 5-15P 030221	030221 1
46a	3113491	GRID-WIRE RECTANGULAR WHITE EXTERIOR 430X220MM 5130046	5130046 1
46b	3151611	GRID-WIRE RECTANGULAR BLACK EXTERIOR 430X220MM 5130208	5130208 1
46c	3151612	GRID-WIRE RECTANGULAR GRAY EXTERIOR 430X220MM 5130253	5130253 1
47a	3123292	GLASS-LD SLIDING GRAY 2200 SUPERIOR W HANDLE C093010	C093010 1
47b	3151628	GLASS-LD SLIDING BLACK 2200 SUPERIOR W HANDLE C093114	C093114 1
48a	3123288	GLASS-LD SLIDING GRAY 2200 INFERIOR W HANDLE C093009	C093009 1
48b	3151627	GLASS-LD SLIDING BLACK 2200 INFERIOR W HANDLE C093113	C093113 1

PARTS LIST			
ITEM	PART NUMBER	TITLE	CROSS REF PN QTY
49	3113538	HEATER-DEFROST RESISTANCE 031098	031098 1
50	3113494	PLATE-SUPPORT DEFROST PROBE 5150008	5150008 1
51a	3113486	DIVIDER-PLASTIC SUPPORT 5110854	5110854 6
51b	3154680	DIVIDER-PLASTIC SUPPORT BLK 5110450	5110450 6
52a	3113487	SUPPORT-SHELF PLASTIC WALL BLK 5110851	5110851 8
52b	3154679	SUPPORT-SHELF PLASTIC WALL BLK 5110444	5110444 8
53a	3113539	SHELF-WIRE 500MM 5130004	5130004 3
53b	3154688	SHELF-WIRE 500MM BLK 5130312	5130312 3
54	3113540	PRICE TAG-HOLDER 2045MM 5110701	5110701 1
55a	3113482	SHELF-WIRE 450MM 5130003	5130003 1
55b	3154689	SHELF-WIRE 450MM BLK 5130313	5130313 1
56a	3113548	SUPPORT-PVC LED GRAY 2056MM 011230	011230 1
56b	3151600	SUPPORT-PVC LED BLACK 2056MM 011396	011396 1
57	3113506	SUPPORT-FAN MOTOR 72MM 090988	090988 1
58a	3123305	CHANNEL-DRAIN SUPERIOR 2053X688MM 011597	011597 1
58b	3154671	CHANNEL-DRAIN SUPERIOR BLK 2053X688MM 011664	011664 1
59a	3123309	CHANNEL-DRAIN INFERIOR 2020X718MM 011601	011601 1
59b	3154670	CHANNEL-DRAIN INFERIOR BLK 2020X718MM 011663	011663 1
60	3123311	SUPPORT-BUMPER 2140MM 011457	011457 2
61	3113547	LED BAR-DIFFUSED 1950MM 5000K ECO AS0C2 031165	031165 1
62	3113543	LD-SEAL PROFILE 10 X 760MM 011227	011227 3
63	3123326	LD-SEAL PROFILE 9MM 011163	011163 1
64	3113544	LD-SLIDING PROFILE 1040MM C010831	C010831 4
65	3113517	MODULE-COMMUNICATION IRP248500 030572	030572 1
66	3129878	SWITCH-HIGH PRESSURE 020638	020638 1
67	3123328	LABEL-CHARGE LEVEL 070006	070006 4
68	3123228	FILTER-DEFROSTING 020643	020643 1
69a	3123246	STOP-LID RH GRAY 5110936	5110936 1
69b	3151609	STOP-LID RH BLACK 5110456	5110456 1
70a	3123245	STOP-LID LH GRAY 5110937	5110937 1
70b	3151608	STOP-LID LH BLACK 5110457	5110457 1

CASE EXPLODED PART VIEWS

BNKR2500A

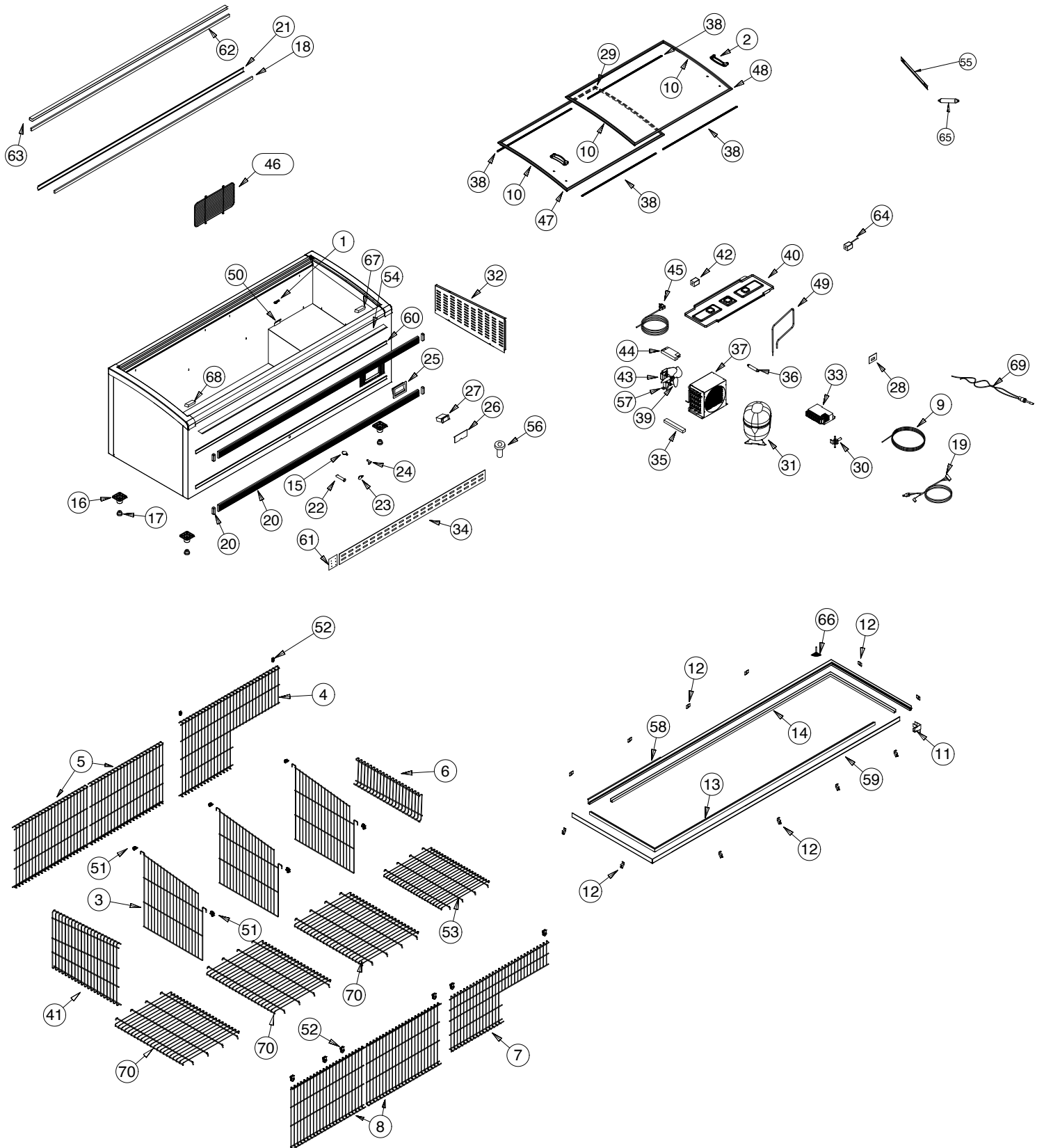

**CASE EXPLODED PARTS  
BNKR2500A**

PARTS LIST				
ITEM	PART NUMBER	TITLE	CROSS REF PN	QTY
48b	3151622	GLASS-LID SLIDING BLACK 2500 SUPERIOR W HANDLE C09.3014	C09.3014	1
49	3113559	HEATER-DEFROST RESISTANCE 03.1099	03.1099	1
50	3113494	PLATE-SUPPORT DEFROST PROBE 515.0008	515.0008	1
51a	3113486	DIVIDER-PLASTIC SUPPORT 511.0854	511.0854	6
51b	3154680	DIVIDER-PLASTIC SUPPORT BLK 511.0450	511.0450	6
52a	3113487	SUPPORT-SHELF PLASTIC WALL 511.0851	511.0851	12
52b	3154679	SUPPORT-SHELF PLASTIC WALL BLK 511.0444	511.0444	12
53a	3113482	SHELF-WIRE 450MM 513.0003	513.0003	1
53b	3154669	SHELF-WIRE 450MM BLK 513.0313	513.0313	1
54	3113560	PRICE TAG-HOLDER 2345MM 511.1001	511.1001	1
55	3123328	LABEL-CHARGE LEVEL 07.0006	07.0006	4
56	314522	SCREW-KICK PLATE 05.0316	05.0316	4
57	3113506	SUPPORT-FAN MOTOR 72MM 09.0988	09.0988	1
58a	3123306	CHANNEL-DRAIN SUPERIOR 2353X688MM 01.1598	01.1598	1
58b	3154676	CHANNEL-DRAIN SUPERIOR BLK 2353X688MM 01.1697	01.1697	1
59a	3123310	CHANNEL-DRAIN INFERIOR 2320X718MM 01.1602	01.1602	1
59b	3154675	CHANNEL-DRAIN INFERIOR BLK 2320X718MM 01.1696	01.1696	1
60	3123313	SUPPORT-BUMPER 2440MM 01.1459	01.1459	2
61	3114521	KICK PLATE-JOIN W SCREWS C519.0036	C519.0036	1
62	3113563	LED BAR-DIFFUSED 2250MM 5000K ECO ASOC2 03.1167	03.1167	1
63a	3113564	SUPPORT-PVC LED GRAY 2356MM 01.1244	01.1244	1
63b	3151601	SUPPORT-PVC LED BLACK 2356MM 01.1415	01.1415	1
64	3113517	MODULE-COMMUNICATION IROPZ4850.03.0572	03.0572	1
65	3123228	FILTER-DEFROSTING 02.0643	02.0643	1
66a	3123302	FILTER-DRAIN CHANNEL 511.0283	511.0283	1
66b	3154682	FILTER-DRAIN CHANNEL BLK 511.0452	511.0452	1
67a	3123246	STOP-LID RH GRAY 51.0936	51.0936	1
67b	3151609	STOP-LID RH BLACK 51.0456	51.0456	1
68a	3123245	STOP-LID LH GRAY 51.0937	51.0937	1
68b	3151608	STOP-LID LH BLACK 51.0457	51.0457	1
69	3129878	SWITCH-HIGH PRESSURE 02.0638	02.0638	1
70a	3151613	SHELF-WIRE 590MM 513.0435	513.0435	3
70b	3155797	SHELF-WIRE 590MM BLK 513.0492	513.0492	3

PARTS LIST				
ITEM	PART NUMBER	TITLE	CROSS REF PN	QTY
23a	3119457	PLUG-WHITE EXTERIOR DRAIN 511.0825	511.0825	1
23b	3151604	PLUG-BLACK EXTERIOR DRAIN 511.0166	511.0166	1
23c	3151605	PLUG-GRAY EXTERIOR DRAIN 511.0228	511.0228	1
24	3113490	DRAIN-PURGE 511.0107	511.0107	1
25a	3123327	PANEL-CONTROL W/ SWITCH R7042 512.0116	512.0116	1
25b	3151610	PANEL-CONTROL W/ SWITCH BLACK 512.0301	512.0301	1
26	3123324	LID-ACRILIC FOR CONTROL PANEL 135 X 57 MM 01.1040	01.1040	1
27	3113449	CONTROLLER-CABEL IR33 VCC 03.0950	03.0950	1
28	3113530	SUPPORT-JOINERS 515.0015	515.0015	4
29	3123326	LID-SEAL PROFILE 9MM 01.1163	01.1163	1
30	3113497	VALVE-0.25 DEFROST SANHUA 02.0323	02.0323	1
31	3113465	COMPRESSOR-EMBRACO FMFT413U I15-230V-50-60HZ R290 02.0599	02.0599	1
32a	3123322	PLATE-EXT SIDE WHT GRD 514.1592	514.1592	1
32b	3151614	PLATE-EXT SIDE BLK GRD 514.1593	514.1593	1
32c	3151616	PLATE-EXT SIDE LIGHT GRAY GRD 514.2160	514.2160	1
32d	3151617	PLATE-EXT SIDE DARK GRAY GRD 514.2161	514.2161	1
33	3113463	INVERTER-FMFT COMPRESSOR FREQUENCY 02.0604	02.0604	1
34	3114519	KICK PLATE-FRONT 2500 519.0035	519.0035	1
35	3113379	TRANSFORMER-LED BAR 60W 2X800MM ASOC2 03.1168	03.1168	1
36	3113464	FILTER-7.56 IN-6-OUT-3 02.0564	02.0564	1
37	3113468	CONDENSER-WIRE ON TUBE 02.0577	02.0577	1
38	3113554	LID-SLIDING PROFILE 1195MM C01.0833	C01.0833	4
39	3113469	FAN BLADE-ASPRANT TUBE HELIX DIA200MM 280EG 02.0079	02.0079	1
40	3123329	TRAY-WATER 512.0295	512.0295	1
41a	3123225	SUPPORT-SIDE SHELF 513.0324	513.0324	1
41b	3154700	SUPPORT-SIDE SHELF BLK 513.0475	513.0475	1
42	3113498	VALVE-1.2W 115V SOLENOID DEFROST SANHUA 02.0607	02.0607	1
43	3113470	MOTOR-FAN HIGH EFFICIENCY IND 02.0602	02.0602	1
44	3113462	BOX-CONNECTOR 0.30834	03.0834	1
45	3113454	CABLE-POWER 3614AWG TYPE-B NEMA 5-15P 03.0221	03.0221	1
46a	3113491	GRID-WIRE RECTANGULAR WHITE EXTERIOR 430X220MM 513.0046	513.0046	1
46b	3151611	GRID-WIRE RECTANGULAR BLACK EXTERIOR 430X220MM 513.0208	513.0208	1
46c	3151612	GRID-WIRE RECTANGULAR GRAY EXTERIOR 430X220MM 513.0253	513.0253	1
47a	3123296	GLASS-LID SLIDING GRAY 2500 INFERIOR W HANDLE C09.3011	C09.3011	1
47b	3151621	GLASS-LID SLIDING BLACK 2500 INFERIOR W HANDLE C09.3013	C09.3013	1
48a	3123301	GLASS-LID SLIDING GRAY 2500 SUPERIOR W HANDLE C09.3012	C09.3012	1

PARTS LIST				
ITEM	PART NUMBER	TITLE	CROSS REF PN	QTY
1a	3113477	SUPPORT-PROBE PLASTIC 511.1259	511.1259	1
1b	3154678	HANDLE-200MM SLIDING LID RAL7042 W SCREWS C511.0549	511.0343	1
2a	3113374	HANDLE-200MM SLIDING LID RAL7042 W SCREWS C511.0549	C511.0549	2
2b	3151629	HANDLE-200MM SLIDING LID BLACK W SCREWS C511.0887	C511.0887	2
3a	3113519	DIVIDER-BIG W SUPPORT C513.0071	C513.0071	3
3b	3154703	DIVIDER-BIG W SUPPORT BLK C513.0307	C513.0307	3
4a	3113520	SUPPORT-SHELF BACK STEP SIDE 513.0014	513.0014	1
4b	3154686	SUPPORT-SHELF BACK STEP SIDE BLK 513.0310	513.0310	1
5a	3113549	SUPPORT-BACK SHELF 600MM 513.0231	513.0231	2
5b	3154691	SUPPORT-BACK SHELF 600MM BLK 513.0316	513.0316	2
6a	3123226	SUPPORT-STEP SIDE SHELF 513.0325	513.0325	1
6b	3154699	SUPPORT-STEP SIDE SHELF BLK 513.0474	513.0474	1
7a	3113524	SUPPORT-SHELF FRONT STEP SIDE 513.0013	513.0013	1
7b	3154687	SUPPORT-SHELF FRONT STEP SIDE BLK 513.0311	513.0311	1
8a	3113550	SUPPORT-FRONT SHELF 600MM 513.0230	513.0230	2
8b	3154690	SUPPORT-FRONT SHELF 600MM BLK 513.0315	513.0315	2
9	3113476	PROBE-NTCO15HP00 15M 03.0499	03.0499	2
10	3113543	LID-SEAL PROFILE 10 X 760MM 01.1227	01.1227	3
11a	3114524	CORNER-DEFROST W HOLE 511.0020	511.0020	1
11b	3154683	CORNER-DEFROST W HOLE BLK 511.0864	511.0864	1
12a	3113500	SUPPORT-DRAIN CHANNEL-EVAPORATOR 511.0971	511.0971	24
12b	3154681	SUPPORT-DRAIN CHANNEL-EVAPORATOR BLK 511.0451	511.0451	24
13	3123244	CHANNEL-ALUMINIUM INFERIOR 2325X707MM C515.0825	C515.0825	1
14	3123230	CHANNEL-ALUMINIUM SUPERIOR 2345X688MM C515.0828	C515.0828	1
15a	3113488	PLUG-INTERIOR DRAIN 511.0105	511.0105	1
15b	3154677	PLUG-INTERIOR DRAIN BLK 511.0204	511.0204	1
16	3113473	LEG-85MM WITH LEVEMER C511.0220	C511.0220	4
17	3113443	LEVELER-M2 X 50MM 511.0017	511.0017	4
18	3113551	LED BAR-2250MM 5000K ECO ASOC2 03.1166	03.1166	1
19	3128218	CABLE-FMFT INVERTER 03.1183	03.1183	1
20a	3123247	BUMPER KIT RAL 7016 I PER CASE C01.1509	C01.1509	1
20b	3128219	BUMPER KIT BLACK I PER CASE C01.1054	C01.1054	1
21	3123320	DIFFUSER-LIGHT 2352MM 511.0570	511.0570	1
22a	3113489	PIPE-WHITE DRAIN 511.0347	511.0347	1
22b	3151606	PIPE-BLACK DRAIN 511.0348	511.0348	1
22c	3151607	PIPE-GRAY DRAIN 511.0349	511.0349	1

**5-16**

NOTES:



# **HUSSMANN<sup>®</sup>**

**To obtain warranty information  
or other support, contact your  
Hussmann representative.  
Please include the model and  
serial number of the product.**

*Hussmann Corporation, Corporate Headquarters: Bridgeton, Missouri, U.S.A. 63044-2483 01 October 2012*

**Husmann Corporation**  
12999 St. Charles Rock Road  
Bridgeton, MO 63044-2483  
[www.husmann.com](http://www.husmann.com)