

# HUSSMANN®

---

## Specialty



---

*Q-Series Family*

# Q1-FS

Single-Deck Service, Straight Glass Merchandiser  
for Seafood Applications

---

[www.husmann.com](http://www.husmann.com)

# Husmann Q-Series Single-Deck Service, Straight Glass Merchandiser for Seafood Applications

## Q1-FS



**Merchandising Flair**  
Enhanced product visibility with solid surface faces and unobstructed product view.



**Quality Fit and Finish**  
Designed for ease of installation simplified glass adjustment and with special alignment parts that assure fit and does not require unsightly joint trim.



**Merchandising Capacity**  
33" product depth in a single deck platform.



**Ergonomic Design**  
Large rear door opening and steep angle allow for ease of access to product.

**Remote Lengths:** 4', 5', 6', 8', and 12'  
**Wedges:** 22° inside and outside wedges  
45° inside and outside wedges  
90° outside wedge

**Q1-FS**  
Straight Glass - Single-Deck Fish

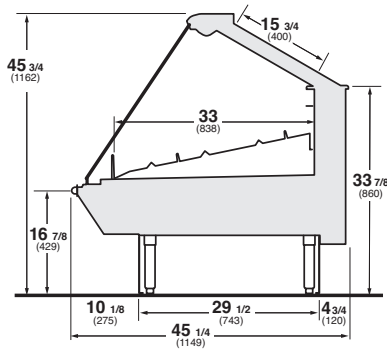

**Q1-FC/FS** Single-Deck Fish

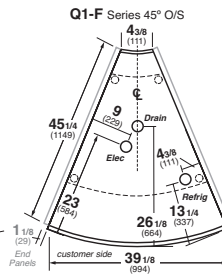
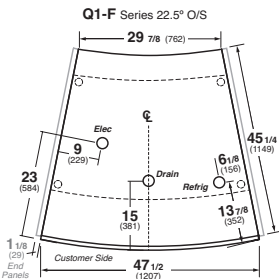
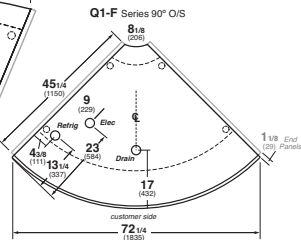
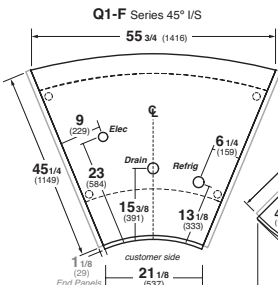
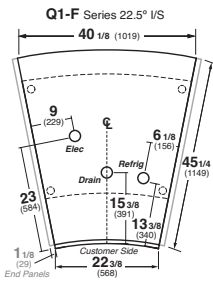
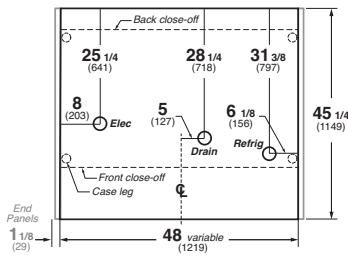

**Intertek Intertek**  
Note.  
Use Husmann's technical data sheets to get precise dimensions for all store layout purposes.

## Features.

- Non-glare tempered, lift-up straight front glass and glass top (consult factory for availability)
- Air sweep
- Mono coil system (5 year warranty)
- Adjustable stainless steel legs
- Adjustable ice pans
- Double-row LED top light
- Coil corrosion protective coating
- Snap-on painted lower front panel
- Silver anodized glass hardware
- Black thermoplastic rear ledge
- Stainless steel front ledge with black vinyl cart bumper
- Removable brushed stainless steel interior wall and deck
- Snap on stainless steel rear close-off panel
- Solar digital thermometer
- Electronic ballast
- Thermostat and suction stop solenoid
- Please reference color chart for choice of standard Husmann paint and finish options ([www.husmann.com](http://www.husmann.com))

## Options.

- Corian® or other solid surface on rear and top ledge surfaces (requires NSF approved materials)
- Rear doors (mirrored or clear glass)
- View or solid ends
- Mirror finish stainless steel inside end panels
- Stainless steel pedestals
- Top mounted scale stand with integrated and communication cables
- LED ledge lights †
- Liquid line shut-off hand valve
- 15 amp and GFCI duplex outlets
- Special interior and exterior finishes
- Adjustable heights for Q-Series families
- Custom lengths and options\* (consult your Husmann sales representative)

## Additional Information:

- Matching companion case lines: **Q1-FC**
- Q-Series Entire Family: **Q-Series Family**
- Single-Deck Service Deli Straight Glass: **Q1-DS**
- Single-Deck Self-Service Deli: **Q1-SS**
- Service Hot Straight Glass: **Q-HS**
- Service Meat or Seafood Straight Glass: **Q3-MS** or **Q3-FS**
- Multi-Deck Service Bakery Straight Glass: **Q3-BS**
- Multi-Deck Service Deli Straight Glass: **Q3-DS**
- Multi-Deck Self-Service Deli: **Q3-SS** or **Q4-SS**
- Multi-Deck Self-Service with Service Top Deli: **Q3-SP**

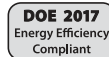

Husmann refrigerated merchandisers configured for sale for use in the United States meet or surpass the requirements of the DOE 2017 energy efficiency standards.

\* Some optional features may need to be certified by UL, NSF, and/or other 3rd party certification agencies. Contact Husmann for verification or questions for availability.

† Only lighting configurations that are compliant with the U.S. Dept. of Energy (DOE) 2017 regulation are available for sale for use in the U.S.A.

NOTE: These merchandisers are designed for use in stores when temperature and humidity do not exceed 75°F and 55% R.H. We reserve the right to change or revise specifications and product design in connection with any feature of our products. Such changes do not entitle the buyer to corresponding changes, improvements, additions, or replacements for equipment previously sold or shipped.

For additional resources, contact your representative or visit [www.husmann.com](http://www.husmann.com).

## Husmann Specialty

13770 Ramona Avenue  
Chino, California 91710-5423  
Ph: 800.395.9229

[www.husmann.com](http://www.husmann.com)