

**HUSSMANN®**

---

Specialty



---

*Q-Series Family*

**Q3-DS**

Multi-Deck Service Merchandiser  
with Straight Glass for Deli Applications

---

[www.hussmann.com](http://www.hussmann.com)

# Husmann Q-Series Multi-Deck Service Merchandiser with Straight Glass for Deli Applications

## Q3-DS



### Merchandising Flair

Stylish clean lines combined with sleek design elements create enhanced product visibility. Granite or solid surface design allows for an amazing merchandising display unlike other service cases.

### Quality Fit and Finish

Designed for ease of installation... it has a simplified glass adjustment with a special alignment design that assures fit - does not require unsightly joint trim.

### Ergonomic Design

Large rear door opening and steep angle allow for ease of access to product.

### EcoShine LED Lighting

- 50% energy savings over T-8.
- 5-10 year lamp life.
- Excellent product illumination.
- Perfect for dimming or On/Off operation.

**Remote Lengths:** 4', 5', 6', 8', 10', and 12'  
**Wedges:** 22.5° inside and outside wedges  
 45° inside and outside wedges  
 90° outside wedge

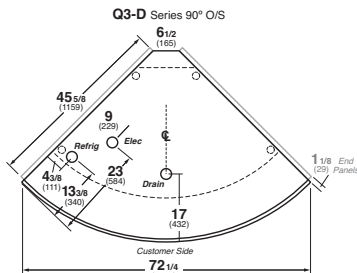
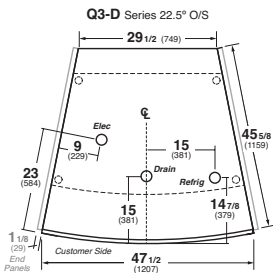
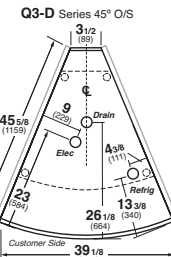
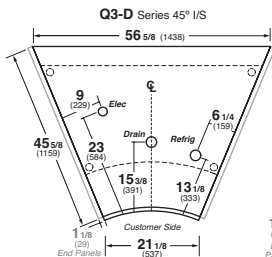
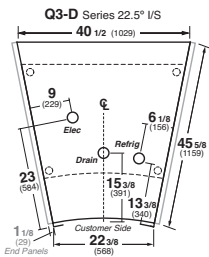
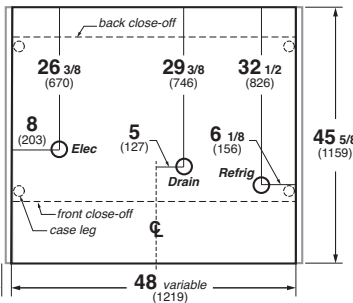
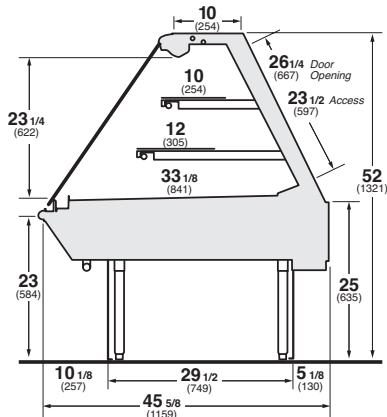

## Features.

- Tempered, non-glare, lift-up straight front clear glass
- Heated air sweep
- Modular coil system (5-year warranty)
- Double row LED canopy light
- Snap-on painted lower front panel
- Silver anodized glass hardware
- Clear glass rear sliding doors
- Black thermoplastic front ledge
- Black vinyl cart bumper
- Coil corrosion protective coating
- Energy efficient fan motors
- Removable brushed stainless steel interior deck
- Snap-on stainless steel rear close-off panel
- Solar digital thermometer
- Thermostat and suction stop solenoid (remote)
- Please reference color chart for choice of standard Husmann paint and finish options ([www.husmann.com](http://www.husmann.com))

## Options.

- 10" and 12" lighted glass or stainless mezzanine shelves
- LED shelf lighting†
- LED ledge lights
- Corian®, granite, or other solid surface front and/or top ledge (NSF approved material)
- Mirrored rear sliding doors
- Adjustable heights for Q-Series families
- View or solid ends
- Mirror finish stainless steel inside end panels
- Stainless steel pedestals
- Top mounted scale stand extensions with dedicated scale outlet and Cat 5 scale connections
- Thermoplastic wrapping board
- 15 amp GFCI duplex outlets
- Liquid line shut-off hand valve
- Special interior and exterior finishes\* (consult your Husmann sales representative)

## Additional Information:

- Matching companion case lines: **Q-Series Family**
- Single-Deck Service Deli Straight Glass: **Q1-DS**
- Service Hot Straight Glass: **QHS**
- Single-Deck Service Meat or Fish Straight Glass: **Q1-MS or Q1-FS**
- Single-Deck Self-Service: **Q1-SS**
- Multi-Deck Service Deli Straight Glass: **Q3-DS**
- Multi-Deck Service Bakery Straight Glass: **Q3-BS**
- Multi-Deck Self-Service: **Q3-SS or Q4-SS**
- Multi-Deck Self-Service Front with Service Prep Top: **Q3-SP**

**DOE 2017 Energy Efficiency Compliant**

Husmann refrigerated merchandisers configured for sale for use in the United States meet or surpass the requirements of the DOE 2017 energy efficiency standards.

\* Some optional features may need to be certified by UL, NSF, and/or other 3rd party certification agencies. Contact Husmann for verification or questions for availability.

† Only lighting configurations that are compliant with the U.S. Dept. of Energy (DOE) 2017 regulation are available for sale for use in the U.S.A.

NOTE: These merchandisers are designed for use in stores when temperature and humidity do not exceed 75°F and 55% R.H. We reserve the right to change or revise specifications and product design in connection with any feature of our products. Such changes do not entitle the buyer to corresponding changes, improvements, additions, or replacements for equipment previously sold or shipped.

For additional resources, contact your representative or visit [www.husmann.com](http://www.husmann.com).



**Note.** Use Husmann's technical data sheets to get precise dimensions for all store layout purposes.

**Intertek Intertek**

## Husmann Specialty

13770 Ramona Avenue  
 Chino, California 91710-5423  
 Ph: 800.395.9229

[www.husmann.com](http://www.husmann.com)