

HUSSMANN®

IMPACT™ Merchandisers

Startup

Instruction Supplement

for

M1CIMP-4B

Self Contained Spot Merchandiser



Begin with power cord
UNPLUGGED!

The condensing unit should be started up and checked to ensure proper performance before installing the support brackets and all lower panels. To gain access to the unit's control panel, remove the front close-off panel.

Remove the unit control panel cover. Check all wiring terminal connections and make sure they are tight.

Check defrost settings on the time clock and adjust as needed. Refer to the data sheet (P/N 0480307) provided with the unit for recommended settings.

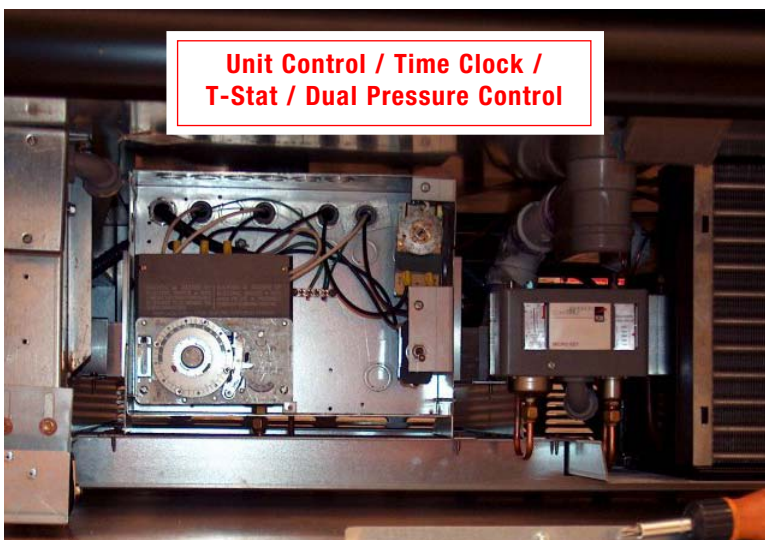
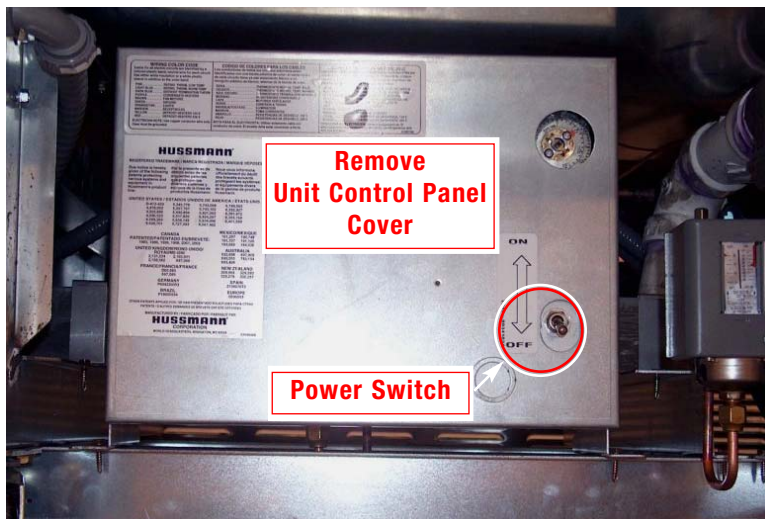
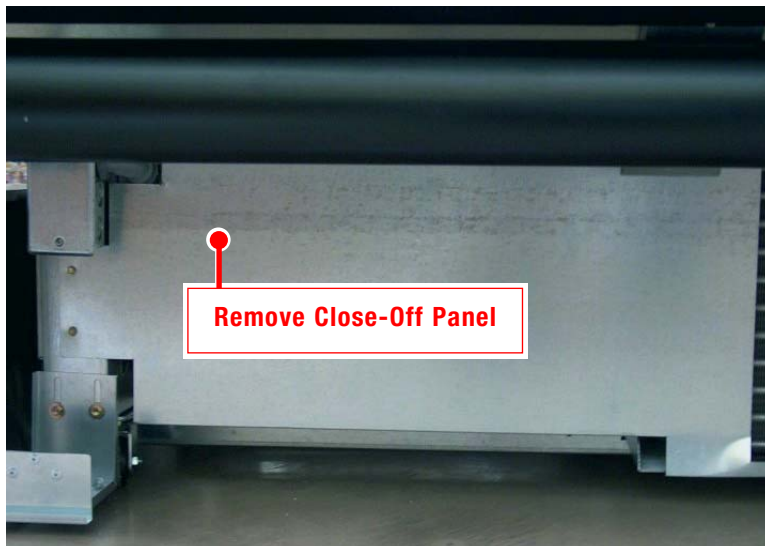

Install a set of refrigeration gauges on the refrigeration system. Plug in the unit's power cord and turn the unit **ON**. Use an Amp-probe to check the compressor amp draw. Adjust the compressor CPR (crankcase pressure regulator) as needed to maintain the rated amp draw of the compressor.



The CPR Valve is Located at the Left Upper Rear of the Compressor Compartment

Check the LP (low pressure) and HP (high pressure) control settings.

While the merchandiser is pulling down in temperature:

- Install the panel retainers so that there is a gap of approximately 1/2-inch between the bottom of the retainer and the floor.

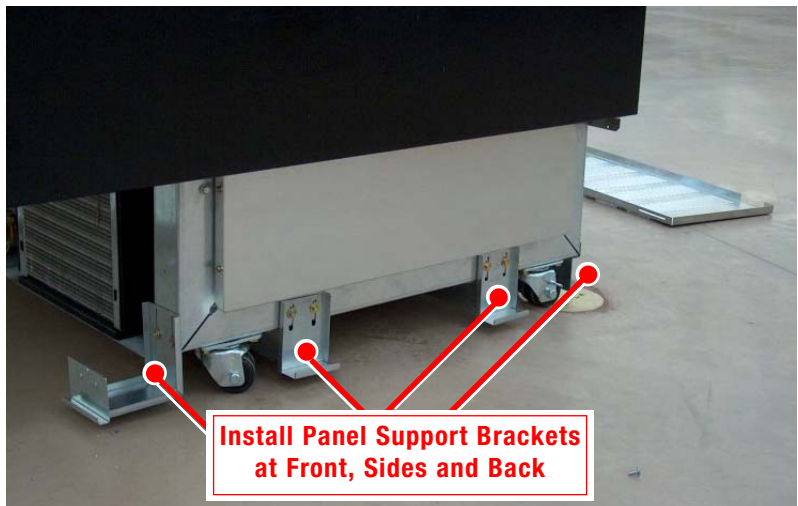

Install Panel Support Brackets at Front, Sides and Back

- Install the return air grilles and plexiglass return air guard.
- Install the plexiglass return air guard.
- Install plug button caps over end bolt holes.
- Install the side and rear panels. Some pre-drilling of holes may be required.



Check the unit's operating pressures before installing the front panel. Advance the time clock to verify it will start a defrost cycle and return to the refrigeration mode on its own. While in the defrost mode, check the operation of the condensate heater to make sure that it operates as required. When you are satisfied with the unit's performance, replace the control panel cover and front close-off panel, then install the vented front panel.

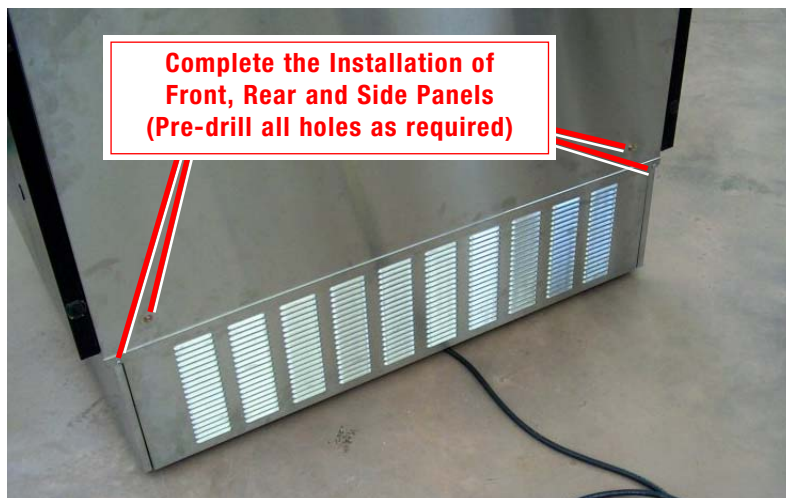
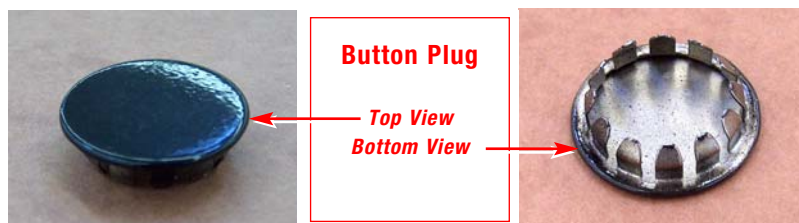

The unit will use less energy, run less, and maintain even product temperature with a clean condenser.

To clean the Condenser, begin by raising the front lower panel up and off the panel brackets. Pull the bottom edge out and allow the panel to clear the upper retainers.

Turn the power switch to “**OFF**” (see Page 1).

Use a vacuum hose or soft brush (non-metallic) to remove dust and debris from the surface of the condenser. Be careful to not damage the condenser.

Once condenser is clean, turn the power switch “**ON**” and re-install the lower front panel.

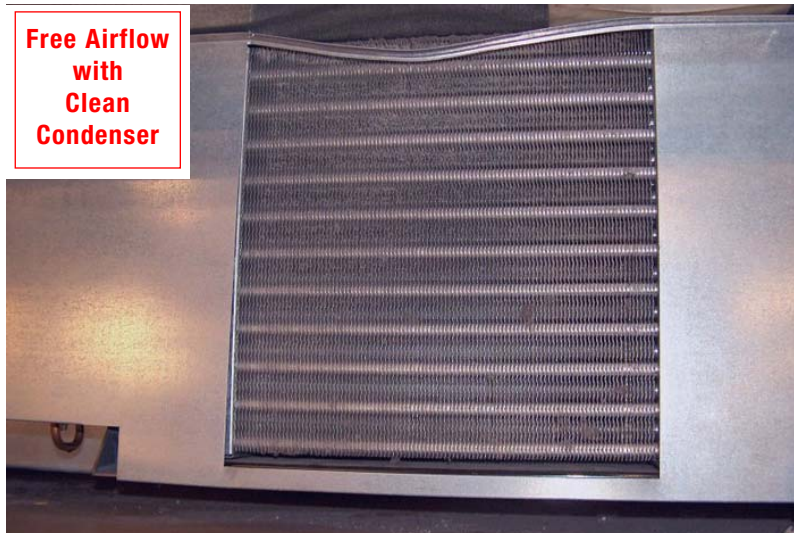
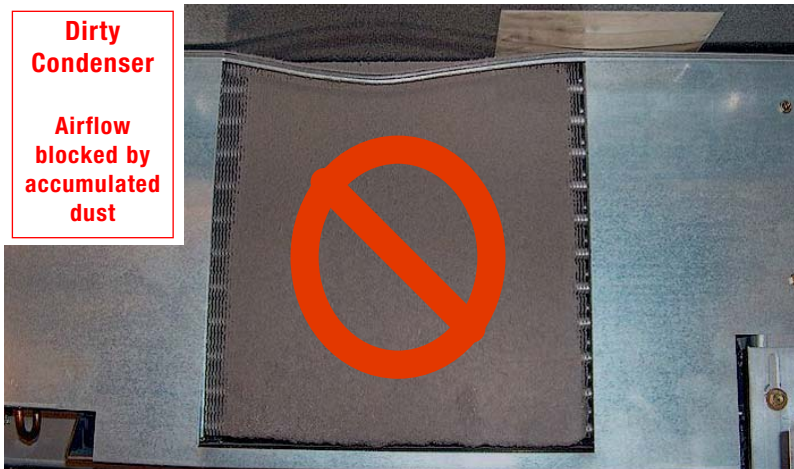
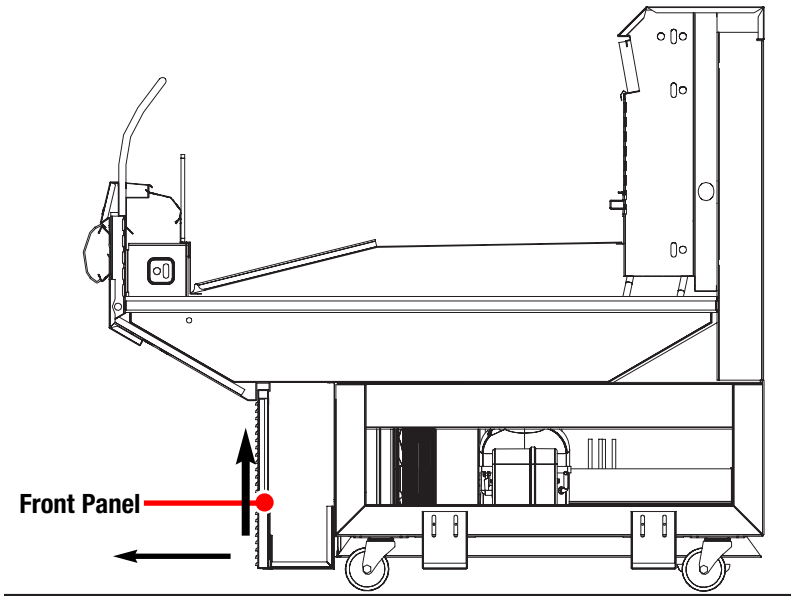

Cleaning the interior of a self-contained display is similar to cleaning remote displays with one major exception:

NEVER USE A HOSE!

The evaporator pan of the self-contained display is sized to eliminate condensate from the refrigeration process, similar to a residential refrigerator.

The evaporator pan must be cleaned regularly.

Exterior Surfaces

The exterior surfaces should be cleaned with a mild detergent and warm water to protect and maintain their attractive finish. **NEVER USE ABRASIVE CLEANSERS OR SCOURING PADS.**

Interior Surfaces

The interior surfaces may be cleaned with most domestic detergents, ammonia based cleaners and sanitizing solutions with no harm to the surface.

Do Not Use:

- Abrasive cleansers and scouring pads, as these will mar the finish.
- Solvent, oil or acidic based cleaners on any interior surfaces.
- Ammonia based cleaners on acrylic surfaces.

Do:

- Remove the product and all loose debris to avoid clogging the waste outlet.
- Store product in a refrigerated area such as a freezer. Remove only as much product as can be taken to the freezer in a timely manner.
- **First turn off refrigeration, then disconnect electrical power.**
- Thoroughly clean all surfaces with soap and hot water. **DO NOT USE STEAM OR HIGH WATER PRESSURE HOSES TO WASH THE INTERIOR. THESE WILL DESTROY THE SEALS CAUSING LEAKS AND POOR PERFORMANCE.**
- Remove screws and lift hinged fan plenum for cleaning. **BE SURE TO REPOSITION THE FAN PLENUM AFTER CLEANING MERCHANDISER.**
- Take care to minimize direct contact between fan motors and water.
- Rinse with hot water, but do NOT flood. **NEVER INTRODUCE WATER FASTER THAN THE WASTE OUTLET CAN REMOVE IT.**
- Allow merchandisers to dry before resuming operation.
- After cleaning is completed, turn on power and refrigeration to the merchandiser.
- Verify that merchandiser is working properly.

