

We reserve the right to change or revise specifications and product design in connection with any feature of our products. Such changes do not entitle the buyer to corresponding changes, improvements, additions or replacements for equipment previously sold or shipped.

Item	Part #	Description	Wiring Item #	Item	Part #	Description	Wiring Item #
FAN ASSEMBLIES AND THERMOSTATS				HEATERS			
8 Ft, 10 Ft, 12 Ft, 14 Ft & 16 Ft				C. Anti-Sweat Heater (3)			
A.	12W Standard Energy Efficient	Fan Assembly (1)		0487118	8 ft, 10 ft (HE.4850668)		
	0477655	Fan Motor, Evaporator (MO.4410546)		0491966	12 ft (HE.4850834)		
	0407532	Fan Blade (FB.4780619) embossing toward motor		0487120	14 ft (HE.4850835)		
				0487121	16 ft (HE.4850836)		
B. Optional Adjustable Refrigeration Thermostat (2)				LAMPS AND BALLASTS			
	0448347	(CT.4481631)		D.	Ballast, Electronic		(4)
				0355398	3 Lamps (BA.4480118)		
				0355716	2 Lamps (BA.0355716)		
				0447740	(BA.4481278)		
				E.	Fluorescent Lamp		(5)
					<i>Replace with like fixtures</i>		

Note: Rev. E makes energy efficient fans standard, adds DOE 2012 compliance. Other changes marked by bar, underline or circle.



Engineering Plan Views

Dimensions shown as inches and (mm).

PHYSICAL DATA

Merchandiser Drip Pipe (in.)	1 1/2
Merchandiser Liquid Line (in.)	3/8
Merchandiser Suction Line (in.)	5/8

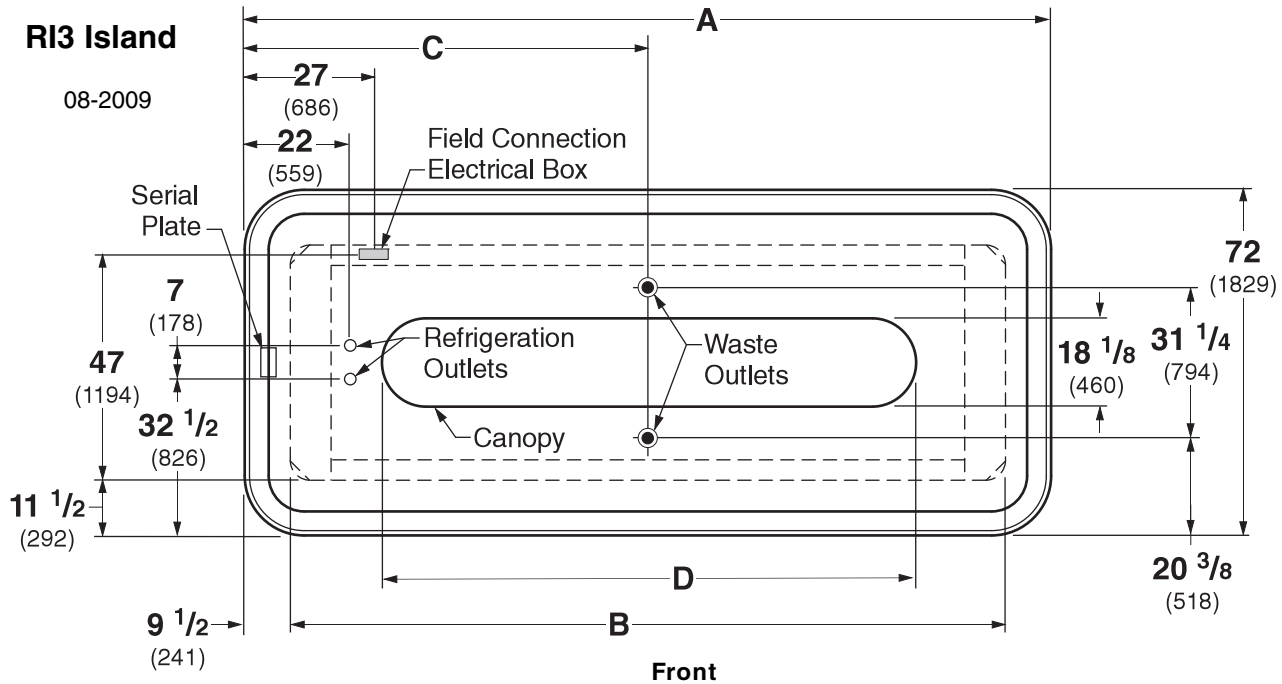

	8 ft	10 ft	12 ft	14 ft	16 ft
General					
(A) Overall Case Length	96 (2438)	120 (3048)	144 (3658)	168 (4267)	192 (4877)
(B) Base Length	77 (1956)	101 (2565)	125 (3175)	149 (3785)	173 (4394)
Maximum O/S dimension of case back to front (includes bumper)	72 (1829)	72 (1829)	72 (1829)	72 (1829)	72 (1829)
Front of splashguard to O/S edge of front base rail	1 5/8 (41)	1 5/8 (41)	1 5/8 (41)	1 5/8 (41)	1 5/8 (41)
Front of case to O/S edge of front base rail	13 1/8 (333)	13 1/8 (333)	13 1/8 (333)	13 1/8 (333)	13 1/8 (333)
Back of case to O/S edge of front base rail	58 7/8 (1495)	58 7/8 (1495)	58 7/8 (1495)	58 7/8 (1495)	58 7/8 (1495)
Width of base rail	1 7/8 (48)	1 7/8 (48)	1 7/8 (48)	1 7/8 (48)	1 7/8 (48)
(D) Length of Canopy	66 1/8 (1680)	66 1/8 (1680)	90 1/8 (2289)	114 1/8 (2899)	138 1/8 (3508)
Width of Canopy	18 1/8 (460)	18 1/8 (460)	18 1/8 (460)	18 1/8 (460)	18 1/8 (460)
Electrical Service (Electrical Field Wiring connection point)					
Center of Electrical service to O/S edge of front base rail	47 (1067)	47 (1067)	47 (1067)	47 (1067)	47 (1067)
Left end of case to center of Field Connection Box	27 (686)	27 (686)	27 (686)	27 (686)	27 (686)
Right end of case to center of Field Connection Box	69 (1753)	93 (2362)	117 (2972)	141 (3581)	165 (4191)
Waste Outlets					
(C) LH End of case to the center of waste outlet	48 (1219)	42 (1067)	42 (1067)	84 (2134)	96 (2438)
Center of front waste outlet to outside of front base rail	8 7/8 (225)	8 7/8 (225)	8 7/8 (225)	8 7/8 (225)	8 7/8 (225)
Center of back waste outlet to outside of front base rail	40 1/8 (1019)	40 1/8 (1019)	40 1/8 (1019)	40 1/8 (1019)	40 1/8 (1019)
Schedule 40 PVC drip pipe	1 1/2 (38)	1 1/2 (38)	1 1/2 (38)	1 1/2 (38)	1 1/2 (38)
Refrigeration Outlet					
LH end of case to center of refrigeration outlet	22 (559)	22 (559)	22 (559)	22 (559)	22 (559)
RH end of case to center of refrigeration outlet	74 (1880)	98 (2489)	122 (3099)	146 (3708)	170 (4318)

Multi-deck Island, 4 Display Levels



Hussmann refrigerated merchandisers configured for sale for use in the United States meet or surpass the requirements of the DOE 2012 energy efficiency standards.



Dimensions shown as inches and (mm).

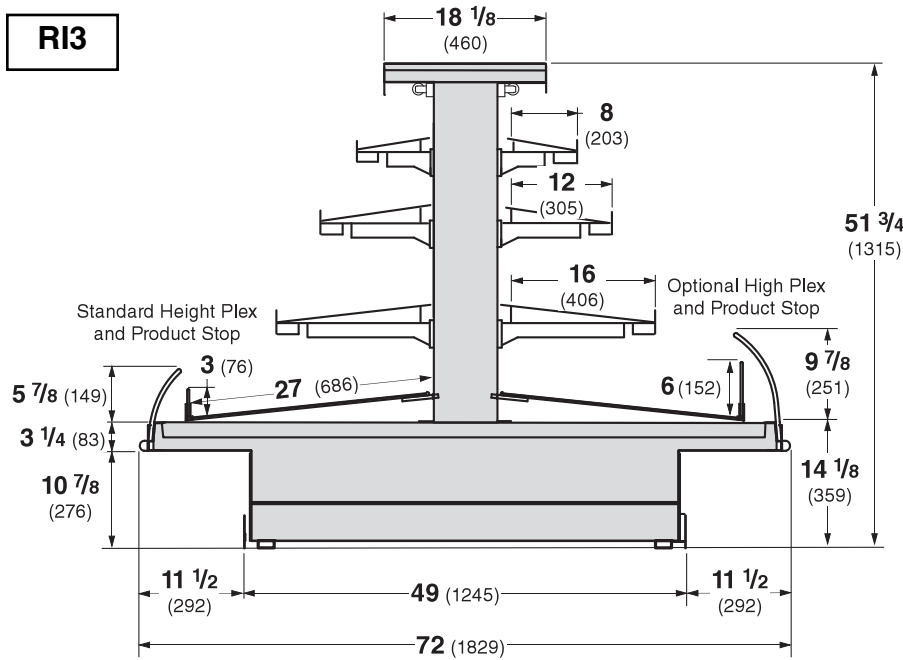

NSF Certification

This merchandiser model is manufactured to meet NSF/ANSI (National Sanitation Foundation) Standard #7 requirements for construction, materials & cleanability.

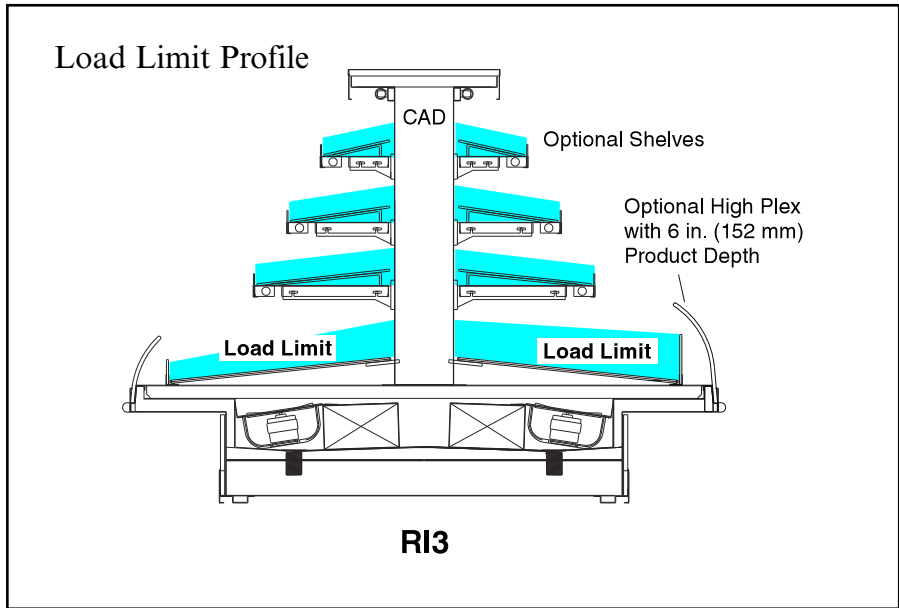

Cases may not function properly if they are loaded above load limits.

Air flow between the shelves, from the Center Air Discharge (CAD) to the return, must be maintained at all times for optimum operating efficiency and to prolong product shelf life. At no time should merchandisers be stocked beyond the load limits indicated.

REFRIGERATION DATA

Note: This data is based on store temperature and humidity that does not exceed 75°F and 55% R.H.

	RI3
Discharge Air (°F)	27
Evaporator (°F)	20
Unit Sizing (°F)	18
Btulhr/ft	
LIT & UNLIT SHELVES	RI3
Parallel	1733
Conventional	1898

DEFROST DATA

	RI3
Frequency (hr)	4
Defrost Water (lb/ft/day)	12
(± 15% based on case configuration and product loading).	

OFFTIME	RI3
Time Terminated (minutes)	20

ELECTRIC OR GAS Not Recommended

CONVENTIONAL CONTROLS

Low Pressure Backup Control	RI3
CI/CO*	14°F / 4°F
Indoor Unit Only, Pressure Defrost Termination*	48°F

*Use a Temperature Pressure Chart to determine PSIG conversions.

Estimated Charge **	RI3
8 ft	1.7 lb 27 oz 0.8 kg
10 ft	2.1 lb 34 oz 1.0 kg
12 ft	2.5 lb 40 oz 1.1 kg
14 ft	3.1 lb 50 oz 1.4 kg
16 ft	3.7 lb 59 oz 1.7 kg

**This is an average for all refrigerant types. Actual refrigerant charge may vary by approximately half a pound (8 oz/0.2 kg).

RI3

Delicatessen

Electrical Data

	8 ft	10 ft	12 ft	14 ft	16 ft						
Number of Fans – 12W	6	8	10	14	16						
			Amperes				Watts				
	8 ft	10 ft	12 ft	14 ft	16 ft	8 ft	10 ft	12 ft	14 ft	16 ft	
Evaporator Fan											
120V 50/60Hz Standard Energy Efficient	1.80	2.40	3.00	4.20	4.80	108	144	180	252	288	
230V 50/60Hz Standard Energy Efficient	NA	NA	NA	NA	NA	NA	NA	NA	NA	NA	
230V 60Hz Export	NA	NA	NA	NA	NA	NA	NA	NA	NA	NA	
230V 50Hz Export	NA	NA	NA	NA	NA	NA	NA	NA	NA	NA	
Anti-sweat Heaters											
120V 60Hz Standard	0.70	0.70	0.90	1.10	1.30	84	84	108	132	156	
230V 50Hz Export	NA	NA	NA	NA	NA	NA	NA	NA	NA	NA	
Minimum Circuit Ampacity (MCA)											
120V 50/60Hz Standard Energy Efficient	2.61	3.21	3.98	5.36	6.13						
230V 50/60Hz Standard Energy Efficient	NA	NA	NA	NA	NA						
230V 60Hz Export	NA	NA	NA	NA	NA						
230V 50Hz Export	NA	NA	NA	NA	NA						
Maximum Over Current Protection 120V	20	20	20	20	20						
Maximum Over Current Protection 230V	NA	NA	NA	NA	NA						

ONLY LIGHTING CONFIGURATIONS THAT ARE COMPLIANT WITH THE U.S. DEPT. OF ENERGY (DOE) 2012 REGULATION ARE AVAILABLE FOR SALE FOR USE IN THE U.S.A.

	8 ft	10 ft	12 ft	14 ft	16 ft	8 ft	10 ft	12 ft	14 ft	16 ft
Standard Lighting										
1 Row Canopy	0.53	0.53	0.83	1.07	1.37	64	64	100	128	164
Optional Lighting										
1 Row of Ledge	1.67	2.00	2.33	2.67	3.00	200	240	280	320	360
Shelf Lighting										
1 Row of Shelves	0.81	0.81	1.11	1.34	1.64	97	97	133	161	197
2 Rows of Shelves	1.62	1.62	2.22	2.68	3.28	194	194	266	322	394
3 Rows of Shelves	2.42	2.42	3.32	4.02	4.92	290	290	398	482	590

115V Lighting Circuit Total = Standard Lighting + Total Optional Lighting + Optional Shelf Lighting

Product Data

RI38

<i>Recommended Usable Cube</i> ¹ (Cu Ft/Case)	54.31 ft ³ /case (1.54 m ³ /case)
<i>AHRI Total Display Area</i> ² (Sq Ft/Case)	60.80 ft ² /case (5.65 m ² /case)
<i>Shelf Area</i> ³ (Sq Ft/Case)	85.76 ft ² /case (7.97 m ² /case)

RI310

<i>Recommended Usable Cube</i> ¹ (Cu Ft/Case)	67.89 ft ³ /case (1.92 m ³ /case)
<i>AHRI Total Display Area</i> ² (Sq Ft/Case)	76.00 ft ² /case (7.06 m ² /case)
<i>Shelf Area</i> ³ (Sq Ft/Case)	107.20 ft ² /case (9.96 m ² /case)

RI312

<i>Recommended Usable Cube</i> ¹ (Cu Ft/Case)	81.47 ft ³ /case (2.31 m ³ /case)
<i>AHRI Total Display Area</i> ² (Sq Ft/Case)	91.20 ft ² /case (8.47 m ² /case)
<i>Shelf Area</i> ³ (Sq Ft/Case)	128.64 ft ² /case (11.95 m ² /case)

RI314

<i>Recommended Usable Cube</i> ¹ (Cu Ft/Case)	95.05 ft ³ /case (2.69 m ³ /case)
<i>AHRI Total Display Area</i> ² (Sq Ft/Case)	106.40 ft ² /case (9.88 m ² /case)
<i>Shelf Area</i> ³ (Sq Ft/Case)	150.08 ft ² /case (13.94 m ² /case)

RI316

<i>Recommended Usable Cube</i> ¹ (Cu Ft/Case)	108.62 ft ³ /case (3.08 m ³ /case)
<i>AHRI Total Display Area</i> ² (Sq Ft/Case)	121.60 ft ² /case (11.30 m ² /case)
<i>Shelf Area</i> ³ (Sq Ft/Case)	171.52 ft ² /case (15.93 m ² /case)

- ¹ AHRI Refrigerated Volume less shelving and other unusable space: Refrigerated Volume/Unit of Length, ft³/ft [m³/m]
- ² Computed using AHRI 1200 standard methodology: Total Display Area, ft² [m²]/Unit of Length, ft [m]
- ³ Shelf surface area is composed of bottom deck plus standard shelf complement, as shown in the Hussmann *Product Reference Guide*. The standard shelf complement for this model is (1) row of 8-inch shelf, (1) row of 12-inch shelf, (1) row of 16-inch shelf.

ESTIMATED SHIPPING WEIGHT ⁴						
Case	<i>8 ft</i>	<i>10 ft</i>	<i>12 ft</i>	<i>14 ft</i>	<i>16 ft</i>	<i>End</i>
lb (kg)	1300 (590)	1500 (680)	1700 (771)	1900 (862)	2100 (953)	NA
⁴ Actual weights will vary according to optional kits included.						

Fan Wiring Offtime Defrost

6, 8, 10, 14 & 16 Fans

- 8 ft — 6 Fans
- 10 ft — 8 Fans
- 12 ft — 10 Fans
- 14 ft — 14 Fans
- 16 ft — 16 Fans

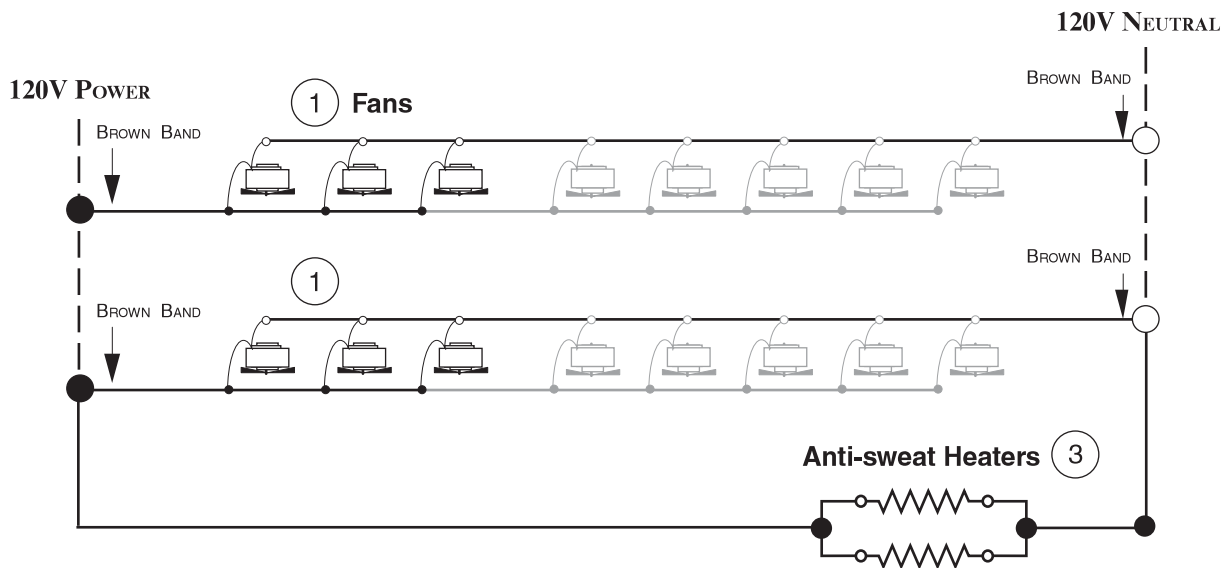

Refrigeration Thermostat

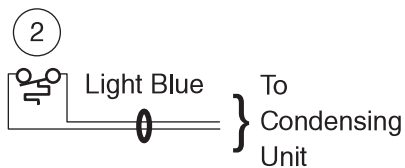

WARNING

All components must have mechanical ground, and the merchandiser must be grounded.

CIRCLED NUMBERS = PARTS LIST ITEM NUMBERS

R = Red Y = Yellow G = Green BL = Blue B = Black W = White

● = 120V POWER ○ = 120V NEUTRAL ⊥ = FIELD GROUND ≡ = CASE GROUND

Standard Lighting — 1 Row Canopy

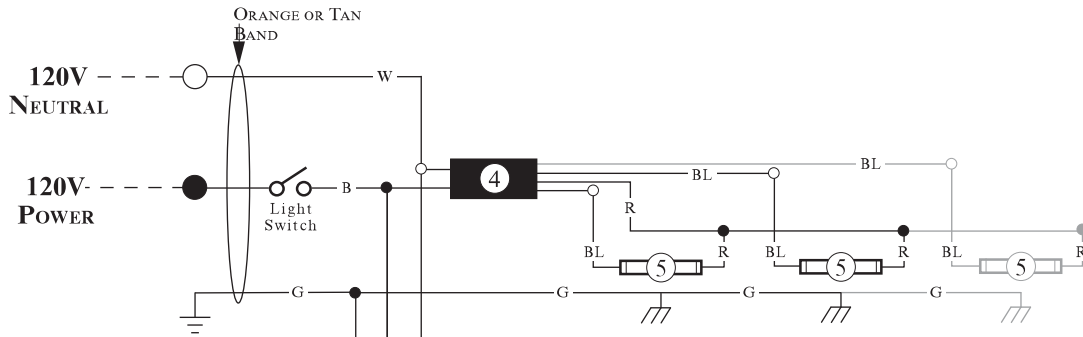

Lighted Shelf Wiring

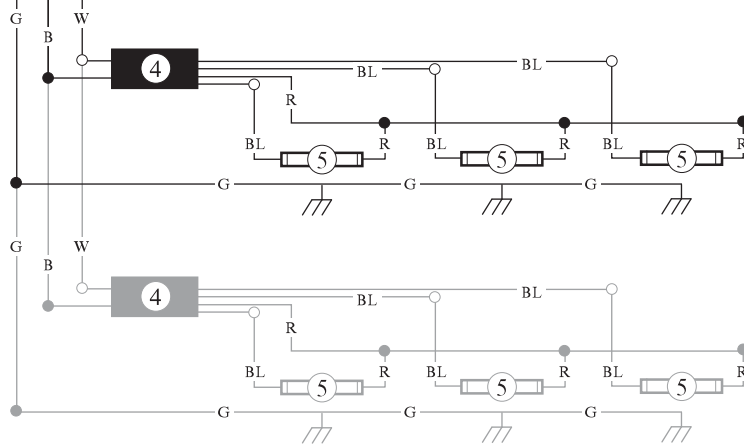

Typical Shelf Ballast Wiring

Maximum lamps per ballast is three (3).
 Different shelf configurations and different case lengths will have more shelf ballasts.

Optional Ledge Light Circuit

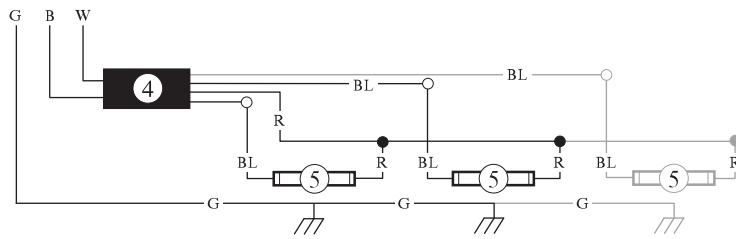

WARNING

All components must have mechanical ground, and the merchandiser must be grounded.

CIRCLED NUMBERS = PARTS LIST ITEM NUMBERS

R = Red Y = Yellow G = Green BL = Blue B = Black W = White

● = 120V POWER ○ = 120V NEUTRAL ≡ = FIELD GROUND ≡ = CASE GROUND