

OPTIONS SHOWN:
 • Lighted Facades
 • Facade Arch
 • Gooseneck Lamps
 • Dry Goods Storage
 • Bump Out Partitions

We reserve the right to change or revise specifications and product design in connection with any feature of our products. Such changes do not entitle the buyer to corresponding changes, improvements, additions or replacements for equipment previously sold or shipped.

Warning:
Terminal block NOT for case-to-case wire connection!

Item	Part #	Description	Wiring Item #	Item	Part #	Description	Wiring Item #
FAN ASSEMBLIES, AND THERMOSTATS				LED FIXTURES AND POWER SUPPLY			
A.	12W Standard	Fan Assembly	(1)	C.	EP.4481861	Power Supply	(3)
	MO.4410103	Fan Motor, Evaporator		D.	BU.4440875	3500K Center	(4)
	FB.4780446	Fan Blade			BU.4440877	4100K Center	(4)
	12W Optional Energy Efficient	Fan Assembly	(1)		BU.4440876	3500K End	(5)
	MO.4410546	Fan Motor, Evaporator			BU.4440878	4100K End	(5)
	FB.4780446	Fan Blade		E.	BU.4441411	2900K 29.5 In. Length	(6)
B.	Optional Adjustable Refrigeration Thermostat		(2)		BU.4441412	2900K 30.5 In. Length	(6)
				F.	BU.4441413	Gooseneck Lamp	(7)
				G.	BU.4441414	Dry Goods Lamp, LED 3500K	(8)
					SH.4991645	KLU9600 Dry Goods Shelf, Lighted, Pearwood	

Refer to INNOVATOR REACH-IN GLASS DOOR INSTALLATION AND SERVICE manual, P/N 0425683, for Innovator and Innovator II door and frame replacement parts.

NOTE: Revision B adds Btu note on page 5, updates stocking level on page 4, updates item numbers on pages 8-11 and updates pages 1, 2, 3, 5, 7, 8, 10 and 11. Changes are underlined, circled or marked with a vertical line in the margin.



Engineering Plan Views

LifeLine Premier RL - RM Plan View 05-2010

PHYSICAL DATA	
Merchandiser Drip Pipe (in.)	1 1/4
Merchandiser Liquid Line (in.)	3/8
Merchandiser Suction Line (in.)	7/8

Reach-In
2, 3, 4 & 5 Door

Dimensions shown as inches and (mm).

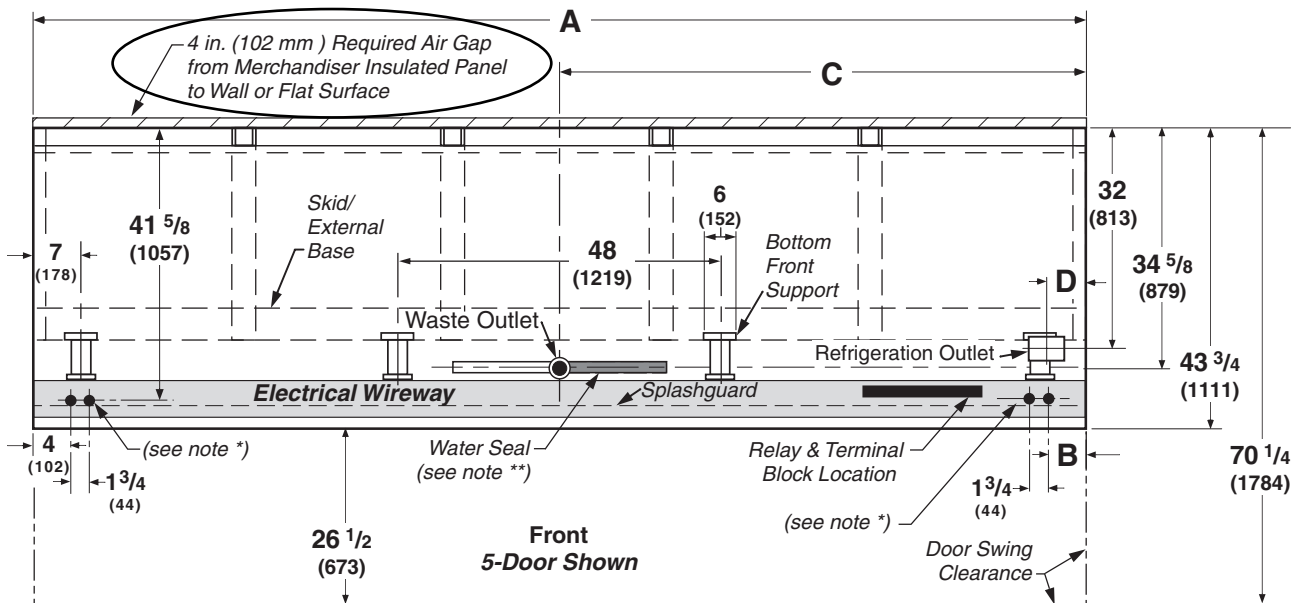

Base footprint 5-door merchandiser is shown above, without Bump Out, Dry Goods, Partitions or Ends.

Illustrated below is a 4-door merchandiser with Dry Goods cabinets and Bump Out end partitions.

Refer to chart on Page 3 for detailed dimensional information on options.

LifeLine Premier — Dry Goods \ Bump Out Plan View



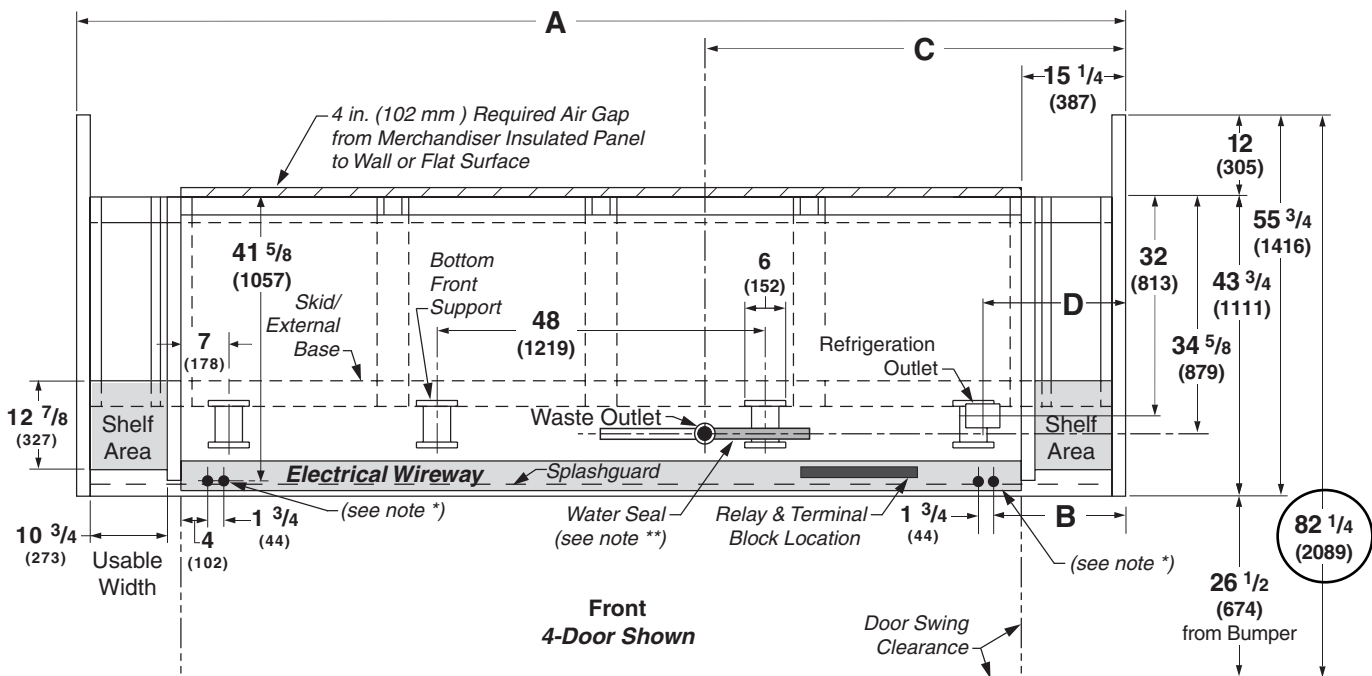

2, 3 & 4 Door

Dimensions shown as inches and (mm).



**Plan View Dimensions for
LifeLine Premier Options**

<p>LifeLine Premier RM With INNOVATOR Doors Medium Temperature</p>

Abbreviations: DG = Dry Goods section BO = Bump Out				
General	2 Dr	3 Dr	4 Dr	5 Dr
(A) Merchandiser Length	62 (1575)	92 1/2 (2350)	122 7/8 (3121)	153 3/8 (3896)
(A) Merchandiser Length BO includes 2 bump-out ends	66 (1676)	96 1/2 (2451)	126 7/8 (3222)	157 3/8 (3997)
(A) Merchandiser Length DG includes 4 ends and dry goods cabinets	92 1/2 (2350)	123 (3124)	153 3/8 (3896)	NA
Maximum O/S dimension of merchandiser back to front ***	43 3/4 (1111)	43 3/4 (1111)	43 3/4 (1111)	43 3/4 (1111)
Maximum O/S dimension of merchandiser back to front BO ***	55 3/4 (1416)	55 3/4 (1416)	55 3/4 (1416)	55 3/4 (1416)
*** Includes bumper. Add 26 1/2 in. (673 mm) for door swing.				
Interior width of dry goods cabinet	10 3/4 (273)	10 3/4 (273)	10 3/4 (273)	NA
Interior depth of dry goods cabinet	12 7/8 (327)	12 7/8 (327)	12 7/8 (327)	NA
Back of merchandiser to rear of splashguard	39 7/8 (1013)	39 7/8 (1013)	39 7/8 (1013)	39 7/8 (1013)
Back of merchandiser to rear of splashguard BO	51 7/8 (1318)	51 7/8 (1318)	51 7/8 (1318)	51 7/8 (1318)
Width of Skid rail	3 3/4 (95)	3 3/4 (95)	3 3/4 (95)	3 3/4 (95)
Width of Bottom Front Support	6 (152)	6 (152)	6 (152)	6 (152)
Stub-up area between front support and splashguard	3 1/8 (79)	3 1/8 (79)	3 1/8 (79)	3 1/8 (79)
Electrical Service 				
(B) RH end of merchandiser to the center of nearest knockout	4 (102)	4 (102)	4 (102)	4 (102)
(B) RH end of merchandiser to the center of nearest knockout BO	6 (152)	6 (152)	6 (152)	6 (152)
(B) RH end of merchandiser to the center of nearest knockout DG	19 1/4 (489)	19 1/4 (489)	19 1/4 (489)	NA
RH end of merchandiser to the center of LH knockout	58 (1473)	88 1/2 (2248)	118 7/8 (3019)	149 3/8 (3794)
Back O/S of merchandiser to center of knockout	41 5/8 (1057)	41 5/8 (1057)	41 5/8 (1057)	41 5/8 (1057)
Back O/S of merchandiser with bump-out to center of knockout	53 5/8 (1362)	53 5/8 (1362)	53 5/8 (1362)	53 5/8 (1362)
* NOTE: Electrical Field Wiring Connection Point is at terminal.				
Waste Outlet 				
(C) Right end of merchandiser to center of waste outlet	23 7/8 (606)	54 1/4 (1378)	46 1/4 (1175)	76 5/8 (1946)
(C) Right end of merchandiser to center of waste outlet BO	25 7/8 (657)	56 1/4 (1429)	48 1/4 (1226)	78 5/8 (1997)
(C) Right end of merchandiser to center of waste outlet DG	39 (991)	69 1/2 (1765)	61 1/2 (1562)	NA
Back O/S of merchandiser with bump-out to center of waste outlet	46 5/8 (1184)	46 5/8 (1184)	46 5/8 (1184)	46 5/8 (1184)
Water Seal 				
Edge of water seal to center of waste outlet	13 (330)	13 (330)	13 (330)	13 (330)
Schedule 40 PVC drip pipe	1 1/4 (32)	1 1/4 (32)	1 1/4 (32)	1 1/4 (32)
** NOTE: Field installed water seal outlets, tees, and connectors are shipped with merchandiser.				
Refrigeration Outlet 				
(D) RH end of merchandiser to center of RH refrigeration outlet	5 3/8 (136)	5 3/8 (136)	5 3/8 (136)	5 3/8 (136)
(D) RH end of merchandiser to center of RH refrigeration outlet BO	7 3/8 (187)	7 3/8 (187)	7 3/8 (187)	7 3/8 (187)
(D) RH end of merchandiser to center of RH refrigeration outlet DG	20 5/8 (524)	20 5/8 (524)	20 5/8 (524)	NA
Back O/S of merchandiser with bump-out to center of refrigeration outlet	44 (1118)	44 (1118)	44 (1118)	44 (1118)
Outside bottom front supports from end of merchandiser	7 (178)	7 (178)	7 (178)	7 (178)
Outside bottom front supports from end of merchandiser BO	9 (229)	9 (229)	9 (229)	9 (229)
Outside bottom front supports from end of merchandiser DG	26 1/2 (673)	26 3/4 (679) RH 37 1/2 (952) LH	26 1/4 (667)	NA
Center bottom front support from Centerline	24 (610)	24 (610)	24 (610)	24 (610)
Center bottom front support from Centerline BO	24 (610)	24 (610)	24 (610)	24 (610)
Center bottom front support from Centerline DG	6 3/4 (171) LH	8 3/4 (222) RH	24 (610)	NA
Distance between Center and Outside supports will vary				

LifeLine Premier RM

With INNOVATOR Doors

Medium Temperature

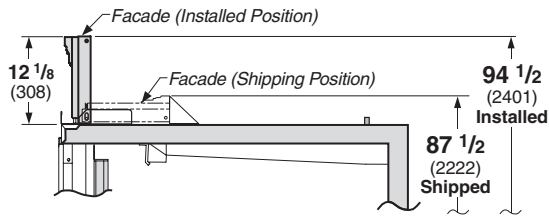

12 in. Straight Facade

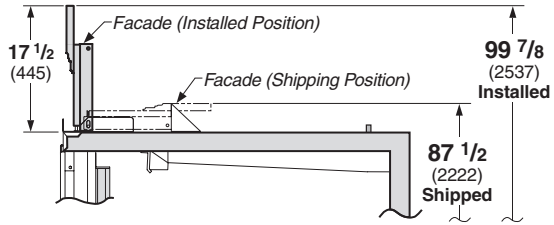

12 in. Arch Facade

Facade Options in Cross Section

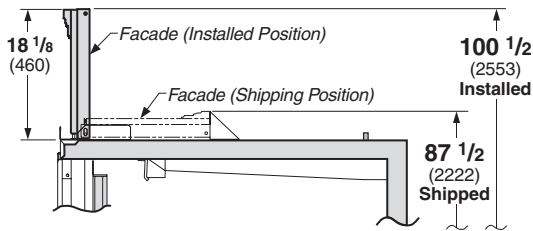

18 in. Straight Facade

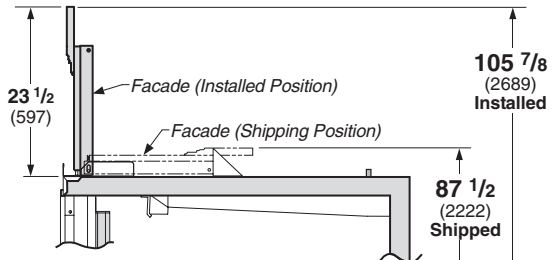

18 in. Arch Facade

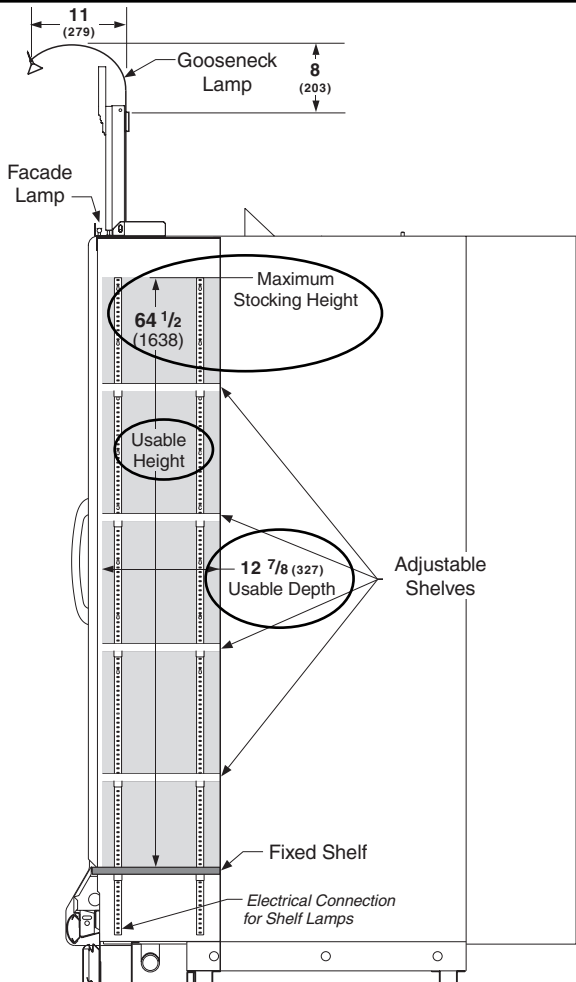

Dry Goods Cross-Section

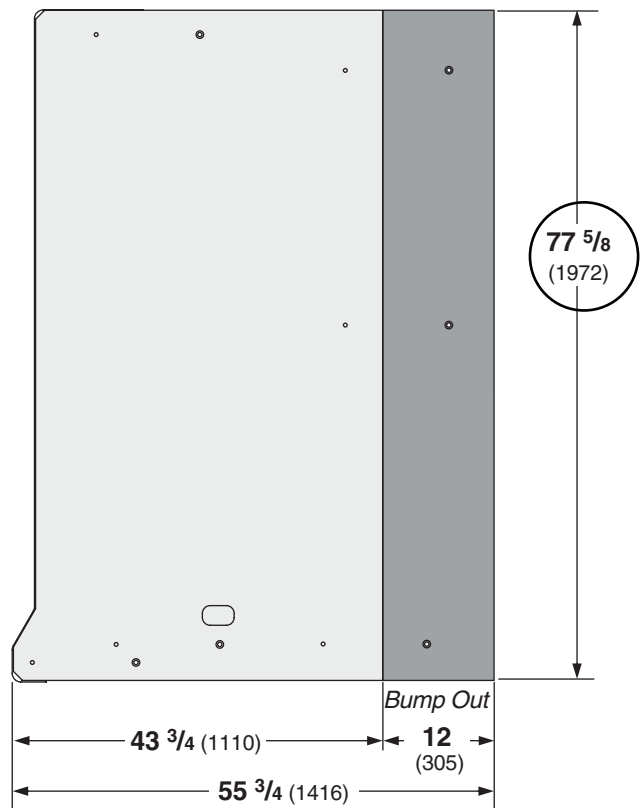

Partition and End Profiles

LifeLine Premier Reach-in 2, 3, 4 and 5 Door Models

LifeLine Premier RM
With INNOVATOR Doors
Medium Temperature

Dimensions shown as inches and (mm).

LifeLine Premier
RL - RM

See Page 4
for alternate
facade heights.

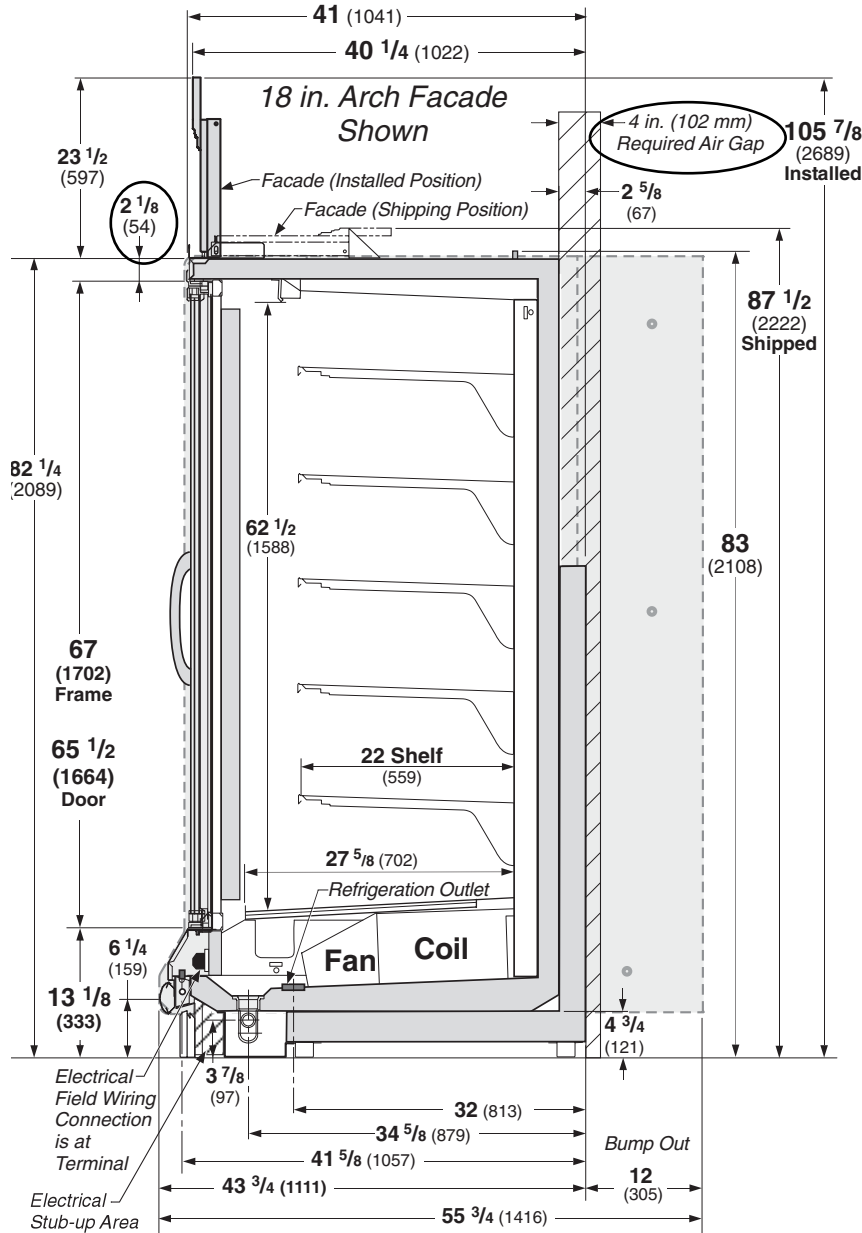

REFRIGERATION DATA

Note: This data is based on store temperature and humidity levels that do not exceed NSF guidelines.

	MEDIUM TEMP	
	NSF TYPE I	NSF TYPE II
Discharge Air °F	32	
Evaporator °F	27	
Unit Sizing °F	25	
BTU/HR/DOOR*		
Temp (°F) /R.H.	75°/55%	80°/55%
Parallel	750	790
Conventional	790	830

*Optional Energy Efficient Fan motors reduce refrigeration load by 109 Btu/hr/Door

DEFROST DATA

Frequency (hr)	24
Defrost Water (lb/Df/day)	0.36
(± 15% based on case configuration and product loading.)	
ELECTRIC	NA
Temp Term (°F)	NA
Failsafe (minutes)	NA
GAS	Not Recommended
OFFTIME	60 minutes

CONVENTIONAL CONTROLS

Low Pressure Backup Control	
CI/CO (Temp °F)**	+20°/+10°
Indoor Unit Only, Pressure Defrost Termination (Temp °F)**	Not Recommended

**Use a Temperature Pressure Chart to determine PSIG conversions.

Estimated Charge ***

2Dr	1.8lb	29 oz	0.8 kg
3Dr	2.7lb	43 oz	1.2 kg
4Dr	3.6lb	58 oz	1.6 kg
5Dr	4.6lb	74 oz	2.1 kg

***This is an average for all refrigerant types. Actual refrigerant charge may vary by approximately 0.5 lb (8 oz / 0.2 kg).

NSF Certification

This merchandiser model is manufactured to meet ANSI/NSF (National Sanitation Foundation) Standard #7 requirements for construction, materials & cleanability.

LifeLine Premier RM
 With INNOVATOR Doors
 Medium Temperature

Hussmann recommends against frame heater cycling with Innovator doors to prevent door seals from freezing to the frames and tearing.

Electrical Data

	2Dr	3Dr	4Dr	5Dr				
Number of Fans—12W	2	3	4	5				
	Amperes				Watts			
Merchandiser	2Dr	3Dr	4Dr	5Dr	2Dr	3Dr	4Dr	5Dr
Evaporator Fan								
120V 60Hz Standard	1.30	1.95	2.60	3.25	100	150	200	250
120V 50Hz Standard	1.50	2.25	3.00	3.75	114	171	228	285
220V 60Hz Export	0.66	0.99	1.32	1.65	100	150	200	250
220V 50Hz Export	0.76	1.14	1.52	1.90	114	171	228	285
120V 60Hz Energy Efficient	0.60	0.90	1.20	1.50	36	54	72	90
220V 60Hz Energy Efficient	0.30	0.45	0.60	0.75	36	54	72	90
Door Anti-sweat Heaters (on fan circuit)	NA							
Frame Anti-sweat Heaters (on fan circuit)								
120V 50/60Hz Standard	0.89	1.34	1.79	2.24	107	161	215	269
220V 50/60Hz Export	0.49	0.73	0.98	1.22	107	161	215	269
Minimum Circuit Ampacity								
120V 60Hz Standard	2.39	3.49	4.59	5.69				
120V 50Hz Standard	2.59	3.79	4.99	6.19				
220V 60Hz Export	1.35	1.92	2.50	3.07				
220V 50Hz Export	1.45	2.07	2.70	3.32				
120V 60Hz Energy Efficient	1.69	2.44	3.19	3.94				
220V 60Hz Energy Efficient	0.99	1.38	1.78	2.17				
Maximum Over Current Protection 120V	20	20	20	20				
Maximum Over Current Protection 220V	15	15	15	15				
Defrost	NA							
Standard Vertical Lighting*	2Dr	3Dr	4Dr	5Dr	2Dr	3Dr	4Dr	5Dr
Hussmann EcoShine™ (24VDC)	0.45	0.68	0.90	1.13	54	81	108	135
Optional LED Lighting (24VDC)								
Facade Lamps	0.79	1.17	1.54	1.92	19	28	37	46
Gooseneck Lamps (2 per merchandiser)	4.17	4.17	4.17	NA**	100	100	100	NA**
Dry Goods Lamps (both sides, 10 per side)	1.50	1.50	1.50	NA**	36	36	36	NA**

* Innovator or Innovator II.

** Dry Goods sections are not available on 5-Door models.

Product Data (Refrigerated Area Only)

<i>Recommended Usable Cube</i> ¹ (Cu Ft/Dr)	23.46 ft ³ /Dr (0.66 m ³ /Dr)
<i>AHRI Total Display Area</i> ² (Sq Ft/Dr)	13.31 ft ² /Dr (1.24 m ² /Dr)
<i>Shelf Area</i> ³ (Sq Ft/Dr)	29.32 ft ² /Dr (2.72 m ² /Dr)

- ¹ AHRI Refrigerated Volume less shelving and other unusable space: Refrigerated Volume/Unit of Length, ft³/ft [m³/m]
² Computed using AHRI 1200 standard methodology: Total Display Area, ft² [m²]/Unit of Length, ft [m]
³ Shelf surface area is composed of bottom deck plus standard shelf complement, as shown in the Hussmann *Product Reference Guide*. The standard shelf complement for this model is (5) rows of 22-inch shelves.

Product Data (Dry Goods Area Only)

<i>TOTAL Gross Usable Cube (Volume for 2 DG per merchandiser)</i>	10.33 ft ³ / (0.29m ³)
---	---

ESTIMATED SHIPPING WEIGHT ⁴					
	<i>2 Dr</i>	<i>3 Dr</i>	<i>4 Dr</i>	<i>5 Dr</i>	Solid End (each)
Standard LifeLine Premier Merchandiser (12-Inch Facade, no Arch)					
lb (kg)	1027 (466)	1340 (608)	1655 (751)	1949 (884)	70 (32)
Standard LifeLine Premier Merchandiser (18-Inch Facade, no Arch)					
lb (kg)	1037 (470)	1355 (615)	1675 (760)	1974 (895)	75 (36)
LifeLine Premier Merchandiser with Two (2) Bump Out Partitions (12-Inch Facade, no Arch)					
lb (kg)	1206 (547)	1519 (689)	1834 (832)	2128 (965)	N/A
LifeLine Premier Merchandiser with Two (2) Bump Out Partitions (18-Inch Facade, no Arch)					
lb (kg)	1229 (557)	1547 (702)	1867 (847)	2166 (982)	N/A
LifeLine Premier Merchandiser with Two (2) Dry Goods Sections, Four (2) Partitions (12-Inch Facade, no Arch)					
lb (kg)	1507 (684)	1820 (826)	2135 (968)	NA	NA
LifeLine Premier Merchandiser with Two (2) Dry Goods Sections, Four (2) Partitions (18-Inch Facade, no Arch)					
lb (kg)	1537 (697)	1855 (841)	2175 (987)	NA	NA
LifeLine Premier Merchandiser with Two (2) Bump Out Partitions, Two (2) Dry Goods Sections, Two (2) Partitions (12-Inch Facade, no Arch)					
lb (kg)	1546 (701)	1859 (843)	2174 (986)	NA	N/A
LifeLine Premier Merchandiser with Two (2) Bump Out Partitions, Two (2) Dry Goods Sections, Two (2) Partitions (18-Inch Facade, no Arch)					
lb (kg)	1579 (716)	1897 (860)	2217 (1006)	NA	N/A
Add 10 lb (5 kg) for Arch					
⁴ Actual weights will vary according to optional kits included.					

Fan and Heater Circuits - Offtime Defrost (standard) Medium Temperature

CIRCLED NUMBERS = PARTS LIST ITEM NUMBERS
 R = Red P = Purple 2P = Purple (2 Bands) DB = Dark Blue BK = Black
 LB = Light Blue Pink = Pink BR = Brown Y = Yellow OR = Orange W = White
THESE ARE MARKER COLORS (WIRE MAY VARY.)

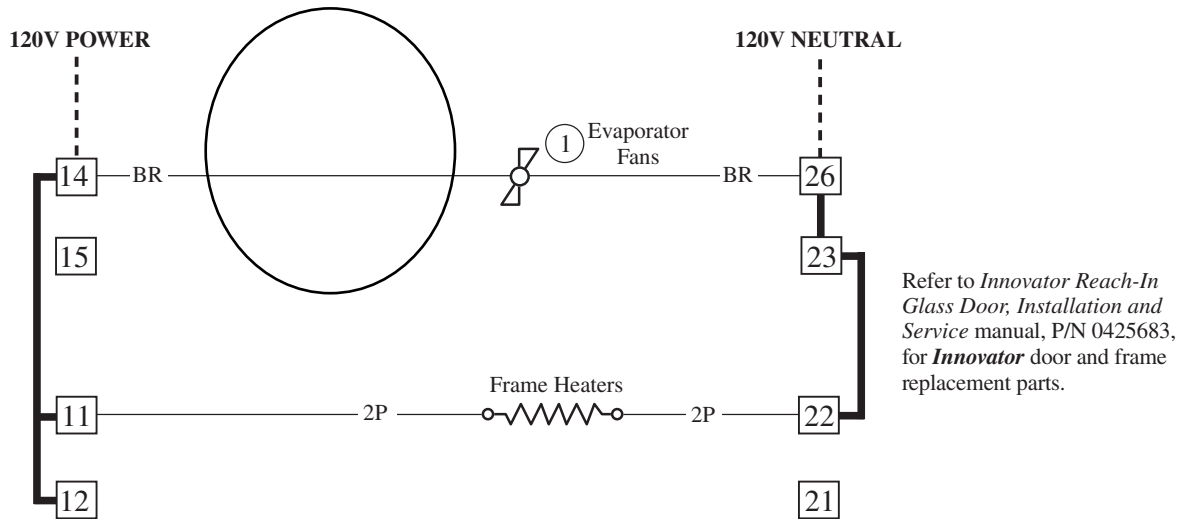

Refer to *Innovator Reach-In Glass Door; Installation and Service manual, P/N 0425683*, for *Innovator* door and frame replacement parts.

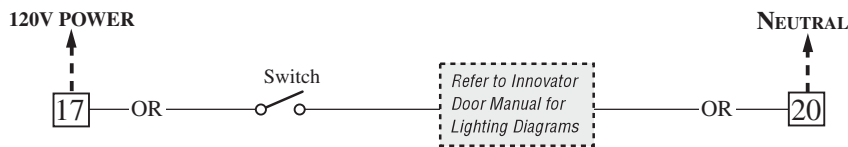

Refer to *Innovator Door Manual for Lighting Diagrams*

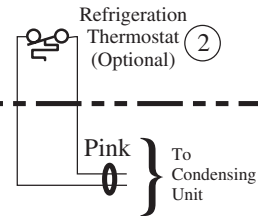

Terminal Blocks in Wireway

Medium Temperature with Offtime Defrost

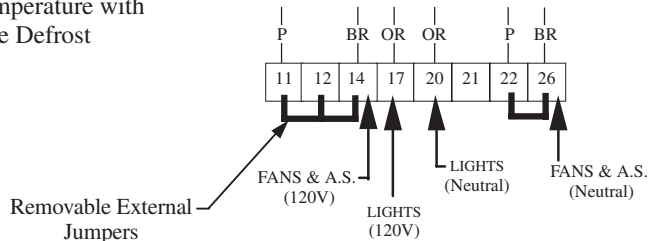

WARNING

All components must have mechanical ground, and the merchandiser must be grounded.

● = 120V POWER ○ = 120V NEUTRAL ⊥ = FIELD GROUND ≡ = CASE GROUND

**Optional
Lighting
LED
Fixtures
Hussmann
EcoShine™**

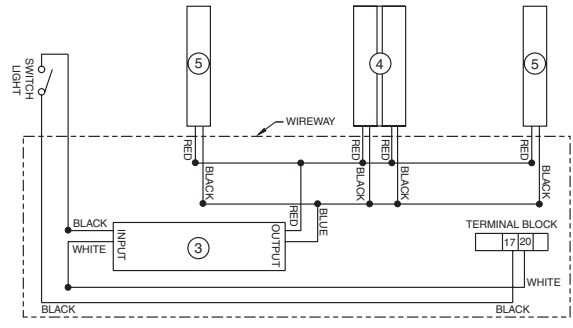

2 DOOR LED LIGHT WIRING DIAGRAM

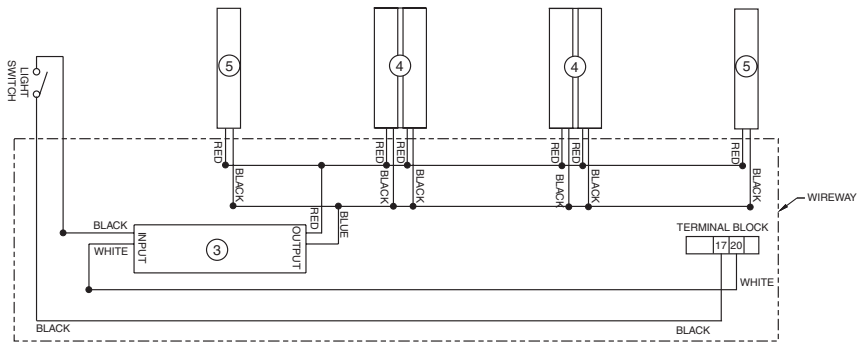

3 DOOR LED LIGHT WIRING DIAGRAM

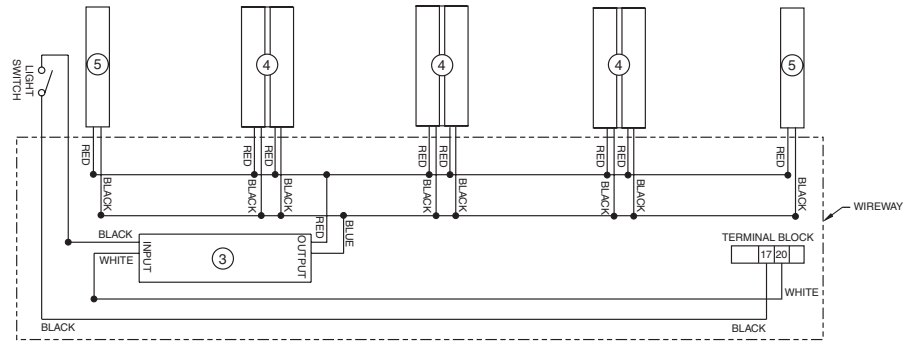

4 DOOR LED LIGHT WIRING DIAGRAM

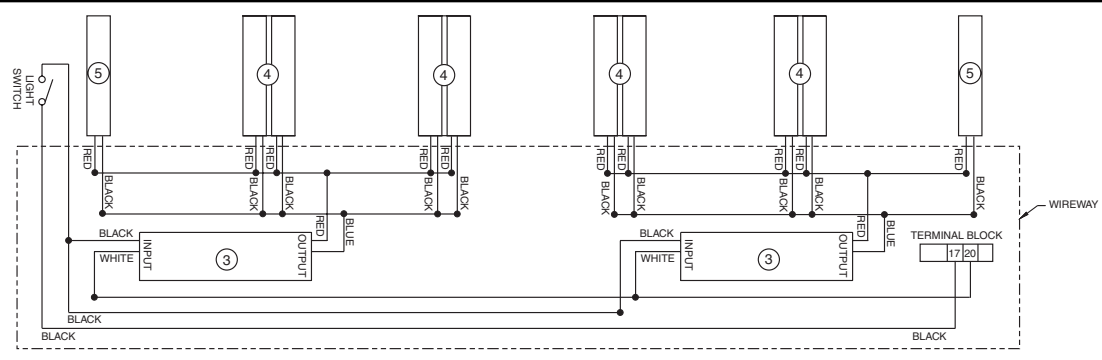

5 DOOR LED LIGHT WIRING DIAGRAM

WARNING

All components must have mechanical ground, and the merchandiser must be grounded.

CIRCLED NUMBERS = PARTS LIST ITEM NUMBERS

R = Red Y = Yellow G = Green BL = Blue BK = Black W = White

● = 120V POWER ○ = 120V NEUTRAL ⊥ = FIELD GROUND ≡ = CASE GROUND

LifeLine Premier RM

With INNOVATOR Doors
Medium Temperature

Optional Lighting Circuits

CIRCLED NUMBERS = PARTS LIST ITEM NUMBERS

R = Red P = Purple 2P = Purple (2 Bands)

DB = Dark Blue BK = Black BL = Blue

BR = Brown Y = Yellow OR = Orange W = White

THESE ARE MARKER COLORS (WIRE MAY VARY.)

Optional External Facade LED Wiring

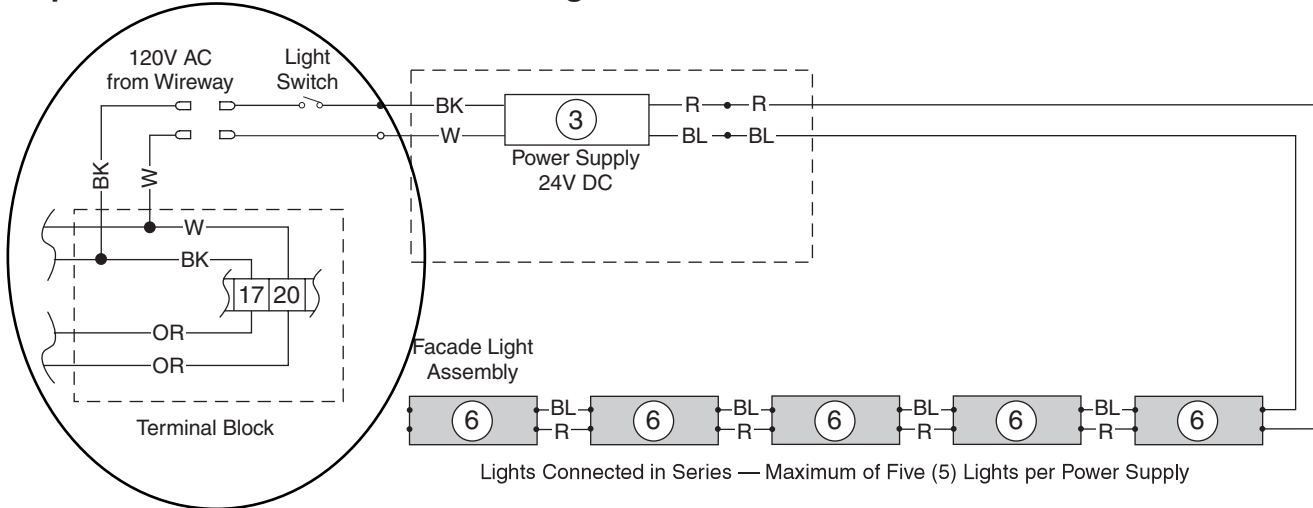

Optional External Gooseneck LED Wiring

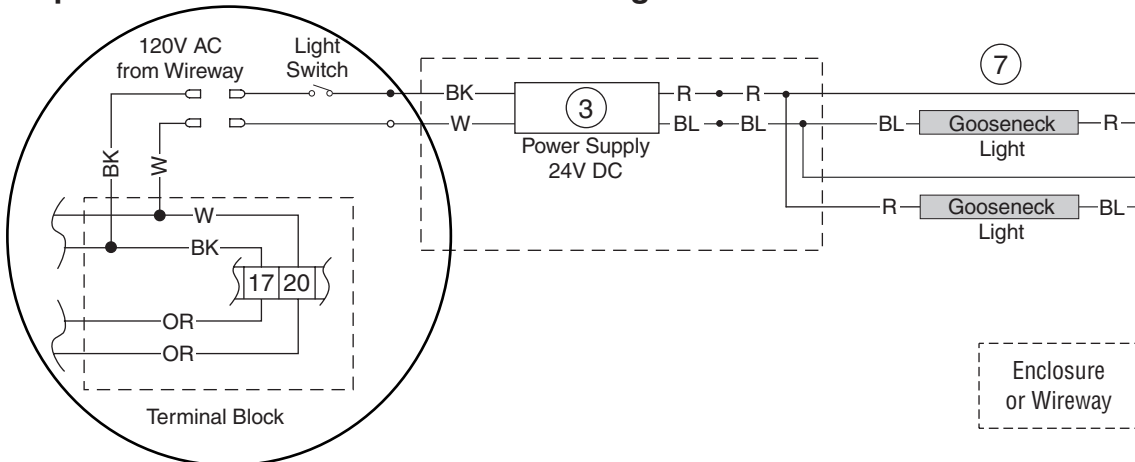

WARNING

All components must have mechanical ground, and the merchandiser must be grounded.

● = 120V POWER ○ = 120V NEUTRAL \perp = FIELD GROUND |||| = CASE GROUND

CIRCLED NUMBERS = PARTS LIST ITEM NUMBERS
 R = Red P = Purple 2P = Purple (2 Bands)
 DB = Dark Blue BK = Black BL = Blue
 BR = Brown Y = Yellow OR = Orange W = White
THESE ARE MARKER COLORS (WIRE MAY VARY.)

LifeLine Premier RM
 With INNOVATOR Doors
 Medium Temperature
Optional Lighting Circuits

Optional External Dry Goods LED Wiring

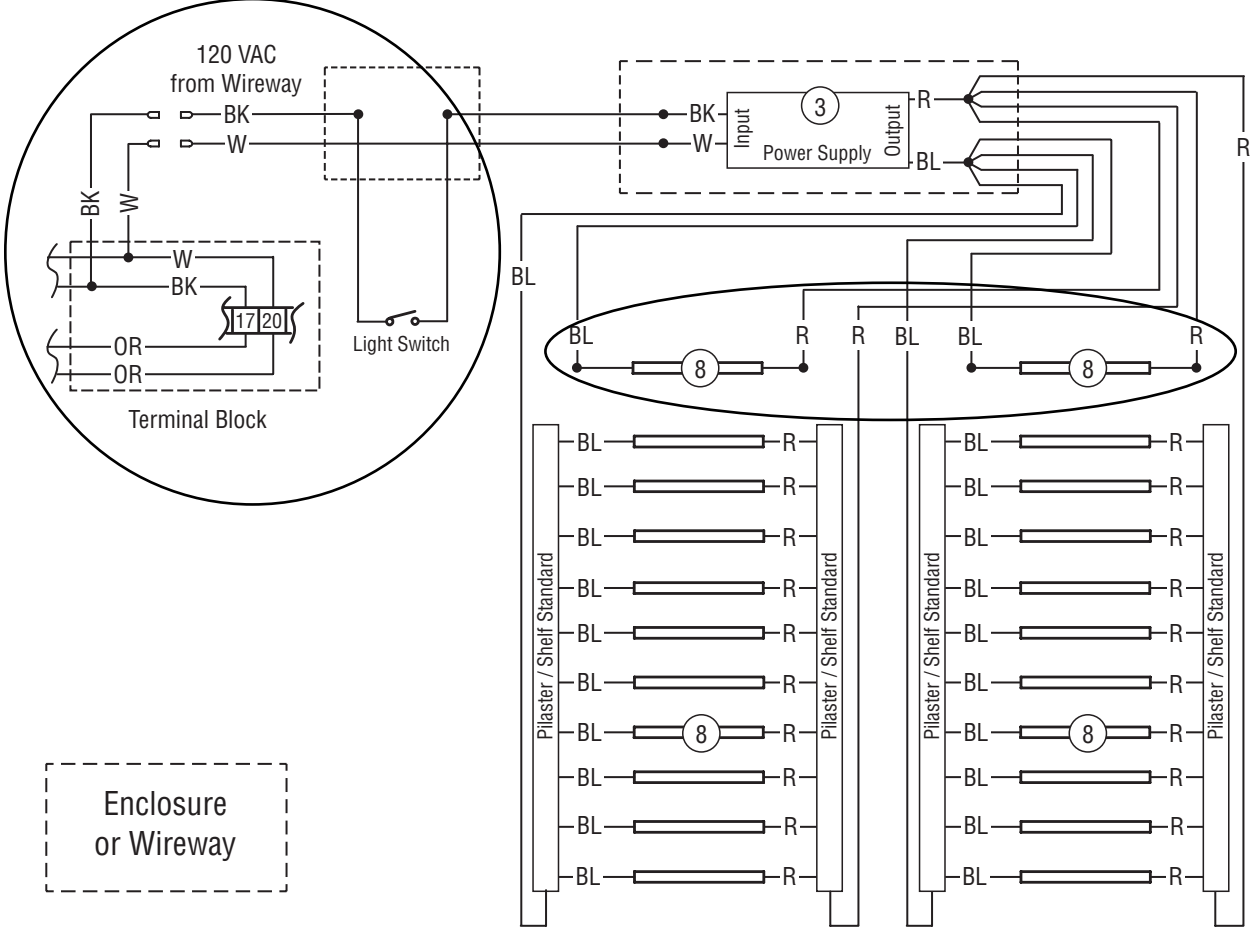

Shelf Lamps (up to 10 per end)

WARNING
 All components must have mechanical ground, and the merchandiser must be grounded.

● = 120V POWER ○ = 120V NEUTRAL ⏏ = FIELD GROUND ⏏ = CASE GROUND