

We reserve the right to change or revise specifications and product design in connection with any feature of our products. Such changes do not entitle the buyer to corresponding changes, improvements, additions or replacements for equipment previously sold or shipped.

Item	Part #	Description	Wiring Item #	Item	Part #	Description	Wiring Item #
<b>FAN ASSEMBLIES AND THERMOSTATS</b>				<b>HEATERS</b>			
<b>8 Ft &amp; 14 Ft</b>				C.	0447688	Anti-Sweat Heater (HE.4850682)	(3)
A.	<b>12W Standard</b>	Fan Assembly	(1)	<b>LAMPS AND BALLASTS</b>			
	0047000	Fan Motor, Evaporator (MO.4410103)		D.	0447683	Ballast, Electronic 2 Lamp (BA.4440811)	(4)
	0376413	Fan Blade (FB.0376413) embossing toward motor		E.		Fluorescent Lamps <i>Replace with like fixtures</i>	(5)
<b>14 Ft Only</b>							
A.	<b>12W Energy Efficient</b>	Fan Assembly	(1)				
	0477655	Fan Motor, Evaporator (MO.4410546)					
	0376413	Fan Blade (FB.0376413) embossing toward motor					
B.	Optional Adjustable Refrigeration Thermostat(2)						
	0448347	(CT.4481631)					

Note: Rev. C makes energy efficient fans standard, adds DOE 2012 compliance. Other changes marked by bar, underline or circle.



# Engineering Plan Views

## PHYSICAL DATA

Merchandiser Drip Pipe (in.)	1 1/2
Merchandiser Liquid Line (in.)	3/8
Merchandiser Suction Line (in.)	5/8

Dimensions shown as inches and (mm).

### RI1N Island

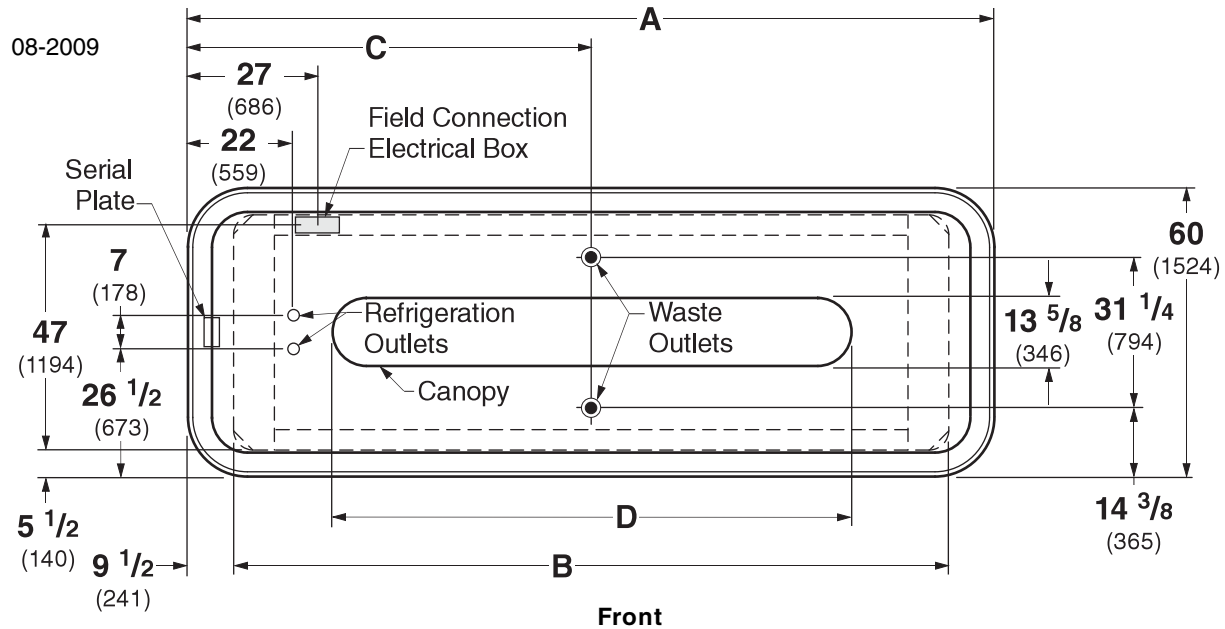

	8 ft	14 ft
<b>General</b>		
<b>(A)</b> Overall Case Length	96 (2438)	168 (4267)
<b>(B)</b> Base Length	77 (1956)	149 (3786)
Maximum O/S dimension of case back to front ( <i>includes bumper</i> )	60 (1524)	60 (1524)
Front of splashguard to O/S edge of front base rail	1 5/8 (41)	1 5/8 (41)
Front of case to O/S edge of front base rail	13 1/8 (333)	13 1/8 (333)
Back of case to O/S edge of front base rail	58 7/8 (1495)	58 7/8 (1495)
Width of base rail	1 7/8 (48)	1 7/8 (48)
<b>(D)</b> Length of Canopy	61 5/8 (1565)	109 5/8 (2784)
Width of Canopy	13 5/8 (346)	13 5/8 (346)
<b>Electrical Service</b> ( <i>Electrical Field Wiring connection point</i> )		
Center of Electrical service to O/S edge of front base rail	47 (1194)	47 (1194)
Left end of case to center of field connection box	27 (686)	27 (686)
Right end of case to center of field connection box	69 (1753)	141 (3581)
<b>Waste Outlets</b>		
<b>(C)</b> LH End of case to the center of waste outlet	48 (1219)	84 (2134)
Center of front waste outlet to outside of front base	8 7/8 (225)	8 7/8 (225)
Center of back waste outlet to outside of front base	40 1/8 (1019)	40 1/8 (1019)
Schedule 40 PVC drip pipe	1 1/2 (38)	1 1/2 (38)
<b>Refrigeration Outlet</b>		
LH end of case to center of refrigeration outlet	22 (559)	22 (559)
RH end of case to center of refrigeration outlet	74 (1880)	146 (3708)

Single Deck Island, 1 Display Level, Narrow Footprint

**DOE 2012 Energy Efficiency Compliant** Hussmann refrigerated merchandisers configured for sale for use in the United States meet or surpass the requirements of the DOE 2012 energy efficiency standards.

**RI1N**  
**Delicatessen**

Dimensions shown as inches and (mm).

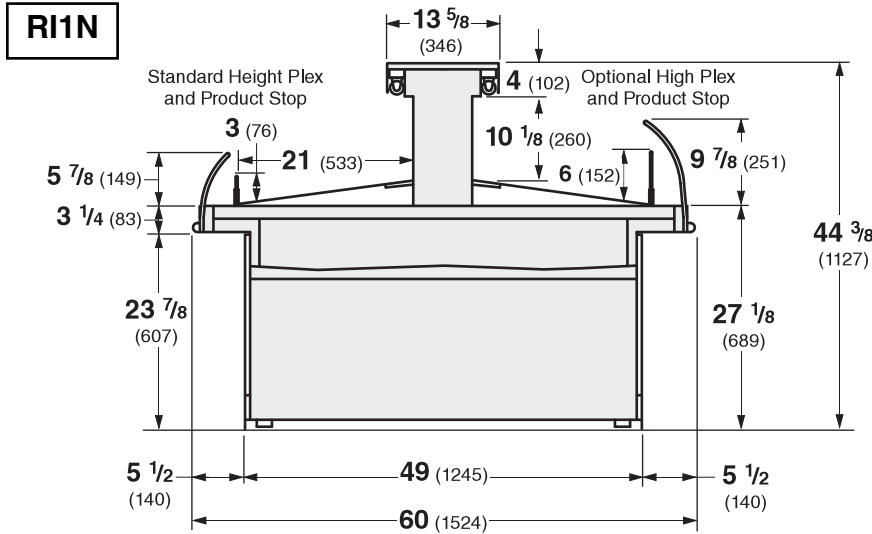

**NSF Certification**

This merchandiser model is manufactured to meet NSF/ANSI (National Sanitation Foundation) Standard #7 requirements for construction, materials & cleanability.

**REFRIGERATION DATA**

**Note:** This data is based on store temperature and humidity that does not exceed 75°F and 55% R.H.

	<b>RI1N</b>
<b>Discharge Air (°F)</b>	27
<b>Evaporator (°F)</b>	15
<b>Unit Sizing (°F)</b>	13
<b>Btu/hr/ft<sup>±</sup></b>	<b>RI1N</b>
<b>Parallel</b>	1260
<b>Conventional</b>	1375

<sup>±</sup>Optional energy efficient motors reduce the refrigeration load by 55 Btu/hr/ft.

**DEFROST DATA**

	<b>RI1N</b>
<b>Frequency (hr)</b>	4
<b>Defrost Water (lb/ft/day)</b>	9

(± 15% based on case configuration and product loading).

<b>OFFTIME</b>	<b>RI1N</b>
<b>Time Terminated (minutes)</b>	20

**ELECTRIC OR GAS** Not Recommended

**CONVENTIONAL CONTROLS**

<b>Low Pressure Backup Control</b>	<b>RI1N</b>
<b>CI/CO*</b>	8°F / -2°F
<b>Indoor Unit Only, Pressure Defrost Termination*</b>	48°F

\*Use a Temperature Pressure Chart to determine PSIG conversions.

<b>Estimated Charge **</b>	<b>RI1N</b>
<b>8 ft</b>	1.7 lb 27 oz 0.8 kg
<b>14 ft</b>	3.1 lb 50 oz 1.4 kg

\*\*This is an average for all refrigerant types. Actual refrigerant charge may vary by approximately half a pound (8 oz/0.2 kg).

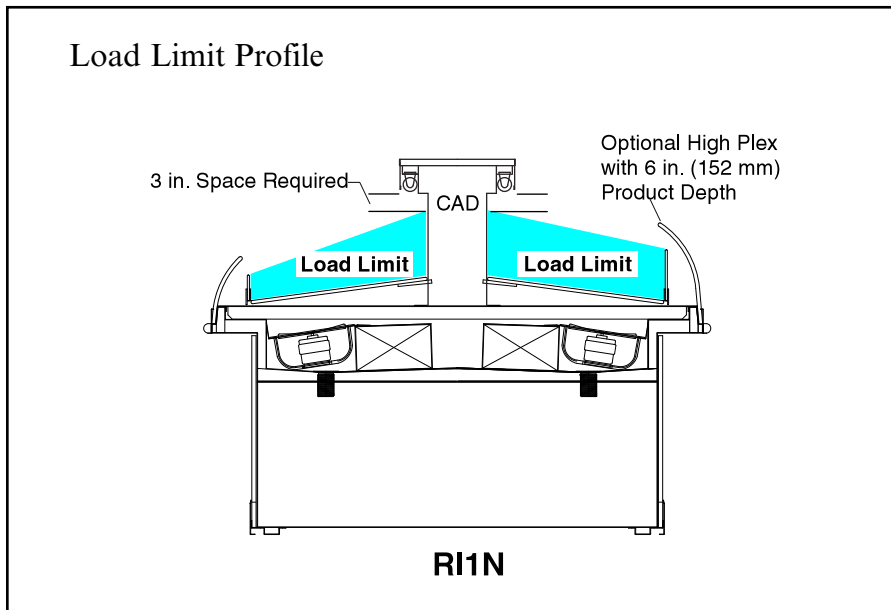

**Cases may not function properly if they are loaded above load limits.**

Air flow between the shelves, from the Center Air Discharge (CAD) to the return, must be maintained at all times for optimum operating efficiency and to prolong product shelf life. At no time should merchandisers be stocked beyond the load limits indicated.

# RI1N

## Delicatessen

### Electrical Data

	8 ft		14 ft			
	4		10			
	Amperes		Watts			
	8 ft	14 ft	8 ft	14 ft		
<b>Evaporator Fan</b>						
120V 60Hz Standard	2.60	6.50	200	500		
120V 50Hz Standard	3.00	7.50	228	570		
230V 60Hz Export	NA	NA	NA	NA		
230V 50Hz Export	NA	NA	NA	NA		
120V 60Hz Energy Efficient	1.20	3.00	72	180		
230V 60Hz Energy Efficient	NA	NA	NA	NA		
<b>Anti-sweat Heaters</b>						
120V 50/60Hz Standard	1.00	1.67	120	200		
230V 50/60Hz Export	NA	NA	NA	NA		
<b>Minimum Circuit Ampacity (MCA)</b>						
120V 60Hz Standard	3.80	8.37				
120V 50Hz Standard	3.72	8.57				
230V 60Hz Export	NA	NA				
230V 50Hz Export	NA	NA				
120V 60Hz Energy Efficient	1.92	4.07				
230V 60Hz Energy Efficient	NA	NA				
<b>Maximum Over Current Protection 120V</b>	<b>20</b>	<b>20</b>				
<b>Maximum Over Current Protection 230V</b>	<b>NA</b>	<b>NA</b>				

ONLY LIGHTING CONFIGURATIONS THAT ARE COMPLIANT WITH THE U.S. DEPT. OF ENERGY (DOE) 2012 REGULATION ARE AVAILABLE FOR SALE FOR USE IN THE U.S.A.

#### Standard Lighting

1 Row Canopy	0.80	1.60	96	192
--------------	------	------	----	-----

#### Optional Lighting

1 Row of Ledge	1.67	2.67	200	320
----------------	------	------	-----	-----

#### Optional Shelf Lighting

None

115V Lighting Circuit Total = Standard Lighting + Total Optional Lighting + Optional Shelf Lighting

**Product Data**

**RI1N8**

<b>Recommended Usable Cube</b> <sup>1</sup> ( <i>Cu Ft/Case</i> )	14.00 ft <sup>3</sup> /case (0.40 m <sup>3</sup> /case)
<b>AHRI Total Display Area</b> <sup>2</sup> ( <i>Sq Ft/Case</i> )	36.64 ft <sup>2</sup> /case (3.40 m <sup>2</sup> /case)
<b>Shelf Area</b> <sup>3</sup> ( <i>Sq Ft/Case</i> )	28.00 ft <sup>2</sup> /case (2.60 m <sup>2</sup> /case)

**RI1N14**

<b>Recommended Usable Cube</b> <sup>1</sup> ( <i>Cu Ft/Case</i> )	24.50 ft <sup>3</sup> /case (0.69 m <sup>3</sup> /case)
<b>AHRI Total Display Area</b> <sup>2</sup> ( <i>Sq Ft/Case</i> )	64.12 ft <sup>2</sup> /case (5.96 m <sup>2</sup> /case)
<b>Shelf Area</b> <sup>3</sup> ( <i>Sq Ft/Case</i> )	49.00 ft <sup>2</sup> /case (4.55 m <sup>2</sup> /case)

- <sup>1</sup> AHRI Refrigerated Volume less shelving and other unusable space: Refrigerated Volume / Unit of Length, ft<sup>3</sup>/ft [m<sup>3</sup>/m]  
<sup>2</sup> Computed using AHRI 1200 standard methodology: Total Display Area, ft<sup>2</sup> [m<sup>2</sup>] / Unit of Length, ft [m]  
<sup>3</sup> Shelf surface area is composed of bottom deck plus standard shelf complement, as shown in the Hussmann **Product Reference Guide**. The standard shelf complement for this model is NONE.

**ESTIMATED SHIPPING WEIGHT <sup>4</sup>**

<b>Case</b>	<i>8 ft</i>	<i>14 ft</i>	<i>End</i>
<b>lb (kg)</b>	1000 (454)	1400 (635)	NA

<sup>4</sup> Actual weights will vary according to optional kits included.

# Fan Wiring Offtime Defrost

## 4 & 10 Fans

8 ft — 4 Fans  
14 ft — 10 Fans

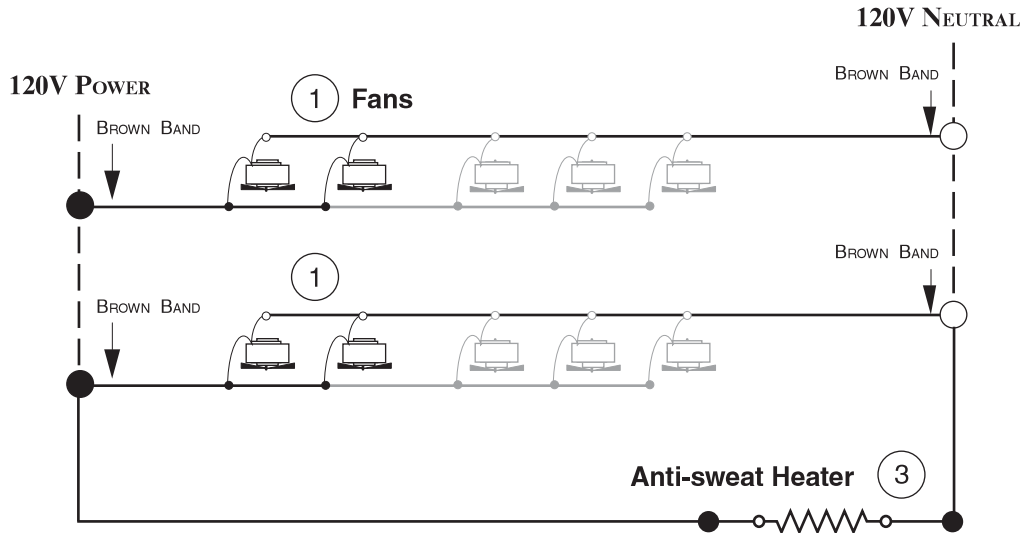

## Refrigeration Thermostat

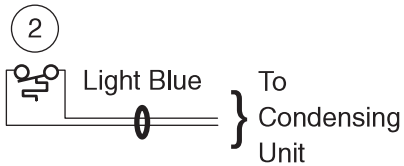

### WARNING

All components must have mechanical ground, and the merchandiser must be grounded.

CIRCLED NUMBERS = PARTS LIST ITEM NUMBERS

R = Red Y = Yellow G = Green BL = Blue B = Black W = White

● = 120V POWER ○ = 120V NEUTRAL ⊥ = FIELD GROUND ≡ = CASE GROUND

### Standard Lighting — 1 Row Canopy

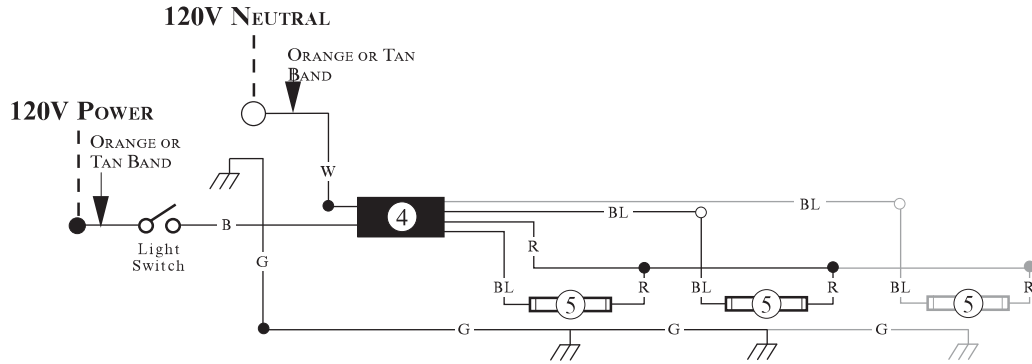

### Optional Ledge Light Circuit

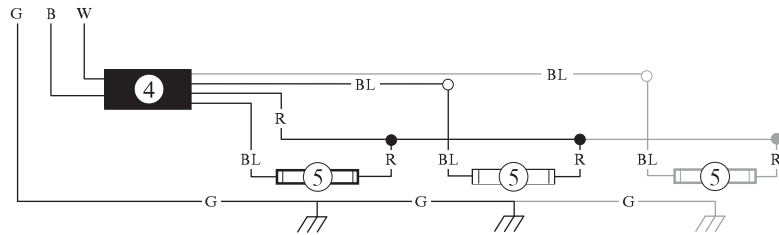

**WARNING**

All components must have mechanical ground, and the merchandiser must be grounded.

CIRCLED NUMBERS = PARTS LIST ITEM NUMBERS

R = Red   Y = Yellow   G = Green   BL = Blue   B = Black   W = White

● = 120V POWER   ○ = 120V NEUTRAL   ⊥ = FIELD GROUND   ≡ = CASE GROUND