

HUSSMANN®

DOE 2017
Energy Efficiency
Compliant

INNOVATOR RIM DOOR SYSTEM FOR WALK-IN COOLERS

INSTALLATION & OPERATION MANUAL



P/N 3034474_E
February 2021



BEFORE YOU BEGIN

Read these instructions completely and carefully.



PERSONAL PROTECTION EQUIPMENT (PPE)

Personal Protection Equipment (PPE) is required whenever servicing this equipment. Always wear safety glasses, gloves, protective boots or shoes, long pants, and a long-sleeve shirt when handling glass.

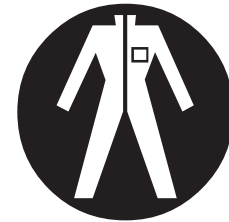
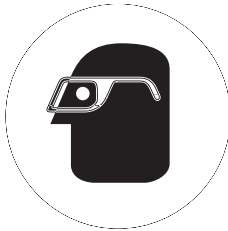

ORIGINAL ISSUE:

REVISION E

Updated DASH Controller to Glass Sentry Controller and updated parts list

REVISION D

Removed Allen Wrench, Page 2, and changed Screw, Page 24

REVISION C

California Warning Update

Revised to B for Team Center

Changed part number from 2402443



This warning does not mean that Hussmann products will cause cancer or reproductive harm, or is in violation of any product-safety standards or requirements. As clarified by the California State government, Proposition 65 can be considered more of a 'right to know' law than a pure product safety law. When used as designed, Hussmann believes that our products are not harmful. We provide the Proposition 65 warning to stay in compliance with California State law. It is your responsibility to provide accurate Proposition 65 warning labels to your customers when necessary. For more information on Proposition 65, please visit the California State government website.

Table of Contents

Parts List	iv	Connect Wiring from Wireway	8
General	1	Field Wiring Connection	9
Application	1	Wiring Diagrams	9
Electrical Specifications	2	Conditioning Gasket	10
Specifications for Opening	2	Service and Maintenance	10
Shipping Damage	2	Replacing Doors	11
Preparation	2	Replacing Door Hinge Spring	11
Install Frame	3	Replacing Magnetic Gasket	11
Apply Sealant	3	Restoring Gasket Seal	13
Check Frame and Opening for Square	3	Door Handle Replacement	15
Place Frame in Opening	3	LED Fixture	16
Fasten Frame to Cooler Wall	4	LED Fixture Replacement	16
Joining Frames	5	LED Power Supply Replacement	17
Seal Inside Frame Perimeter	6	Frame Heater Replacement	18
Attach Door Handles	6	Dimmer Control	19
Install Doors	7	Troubleshooting Guide	22
Adjust Closing Torque	7	Wiring Diagram	23
Adjust Door Sag	8	Replacement Parts Chart	24
Connect Heaters	8		

IMPORTANT
KEEP IN STORE FOR FUTURE REFERENCE

Quality that sets industry standards.

Hussmann Corporation
Corporate Headquarters
12999 St. Charles Rock Road • Bridgeton, MO 63044 U.S.A. • (314) 291-2000
U.S. & Canada 1-800-922-1919 • Mexico 1-800-890-2900
©2021 Hussmann Corporation

PARTS LIST						
Item	Quantity					Description
	1 DOOR	2 DOOR	3 DOOR	4 DOOR	5 DOOR	
1.	1	1	1	1	1	Frame
2.	10	20	30	40	50	Screws
3.	1	1	1	1	1	Silicone
4.	1	2	3	4	5	Doors
Joining						
5.	1	1	1	1	1	Joint Molding
6.	5	5	5	5	5	Binder Post and Screw

Conduit from Wireway

Each frame has the following wires in flexible conduit:

This photo shows the wiring with labels added for clarity. The diagram shows how the wires must be connected.

- A. The *Glass Sentry Controller Harness* is made of two separate wires, one black and one white wire.
- B. The *Ballast Supply Harness* has one white wire and one black wire bound with Tie-wrap.
- C. The *Ground* wire is green.

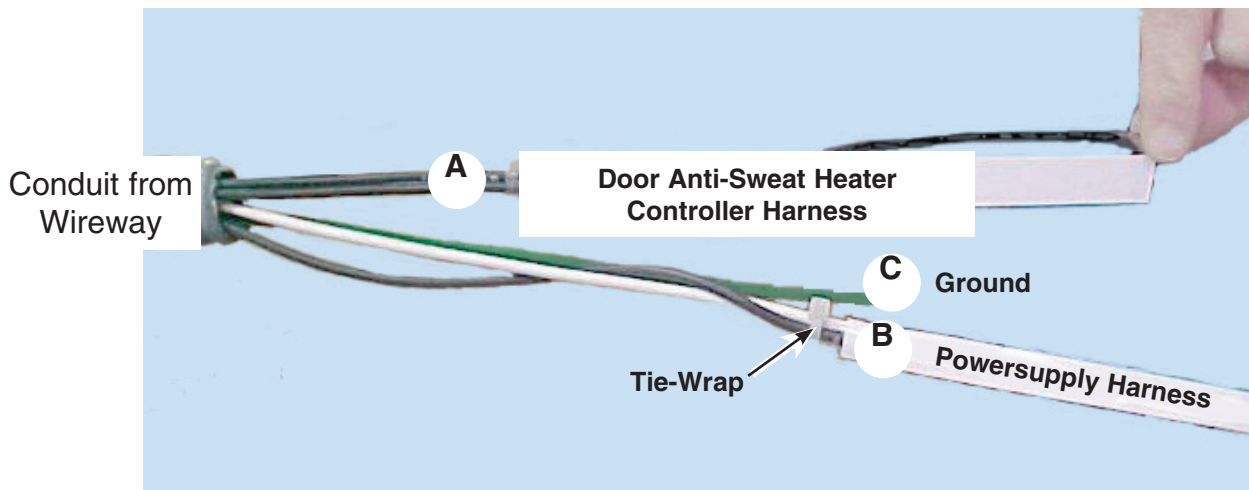

GENERAL

Thank you for choosing Hussmann's *Innovator Cooler Door System*. This document provides information necessary for successful installation and operation of the door system. The door nameplate is attached to the top of the door, handle side, behind the magnetic gasket. The frame nameplate is located on the top left near the switch.



Innovator Cooler Door System

APPLICATION

The Innovator Cooler Door System is designed for installation in new medium temperature or low temperature walk-in coolers with insulated structural walls. To maintain structural integrity of the cooler wall and the door system, the cooler wall must be manufactured with a reinforced opening to match the door frame.



Standard Reinforced Opening

Frames may be joined when more than a 5 door length is needed. Frames to be joined are manufactured without the vertical outside frame flange.



ELECTRICAL SPECIFICATIONS

Appropriate electrical power must be available for the door system, including lighting and heaters. Check the nameplate for minimum circuit ampacity and maximum overcurrent protection device. Always follow NEC guidelines and local codes.

SPECIFICATIONS FOR OPENING

Each door frame is 1 to 5 doors wide. Several standard frame heights are available. Always compare the wall opening dimensions with the frames to be installed.

SHIPPING DAMAGE

All equipment should be thoroughly examined for shipping damage before and during unloading.

This equipment has been carefully inspected at our factory. Any claim for loss or damage must be made to the carrier. The carrier will provide any necessary inspection reports and/or claim forms.

PREPARATION

Clear an area outside the wall opening to lay the frame flat and work around it. Gather tools needed for installation.

Doors are shipped separately from the frame. Set doors aside until frame is installed. Lay the frame face down. Remove all packing materials, packaged parts and tape. Take care not to scratch or otherwise damage frame face.

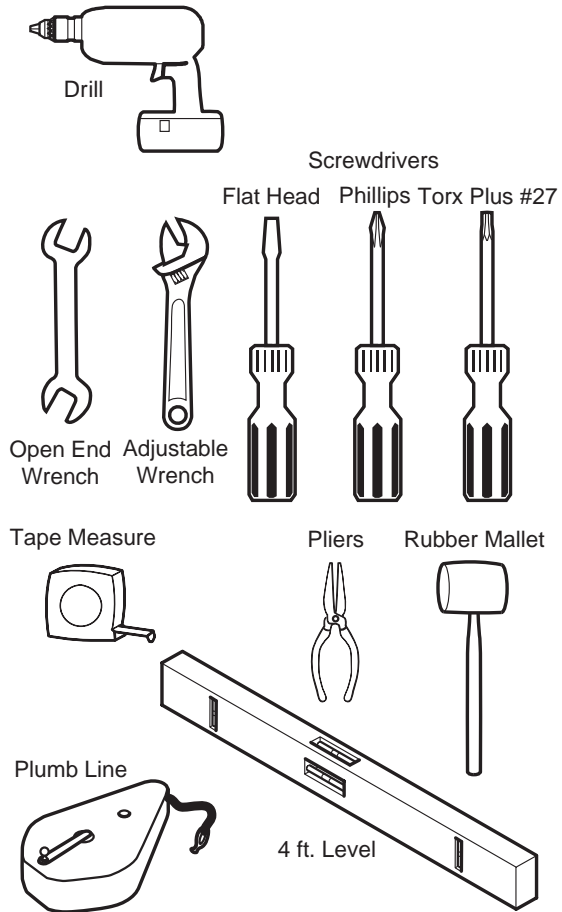

Typical Tools Needed to Install Innovator Cooler Door System



Unpack Frame and Lay Face Down

INSTALL FRAME

Apply Sealant

Apply field-supplied silicone sealant between edge of gasket and outside edge of frame.

Check Frame and Opening for Square

Verify the frame is not racked (out of square)



Apply Silicone Sealant

by measuring from one corner diagonally to the other. The measurements must be the same. Verify that the opening is large enough for the frame. Use a long level (4 ft (1220 mm) or more) to determine if the opening is level side to side. If shims are needed, they must be used under the frame at the bottom of the opening, or at the sides.

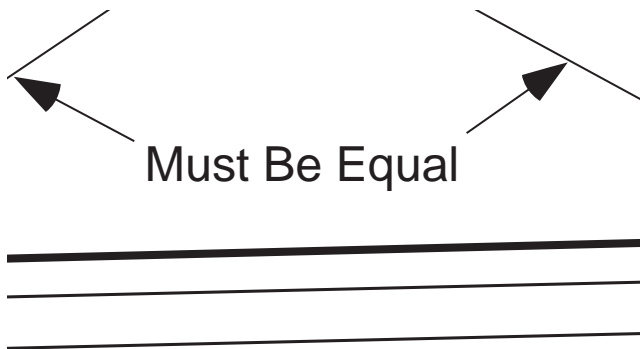

Verify Square Frame

Place Frame in Opening

Lift frame by mullions to avoid gaskets and sealant. Position bottom of frame in opening and then tilt top of frame toward opening. Take care that wiring from wireway at top of frame is not damaged.

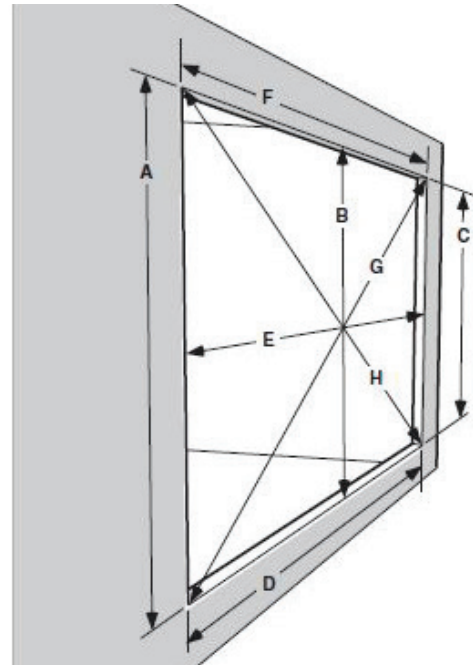

Verify Square and Level Opening



Place Frame in Opening

Use the level to ensure the frame is plumb within the opening. Use shims as needed below and to the side to keep the frame level.



Use the Level

Once the frame is properly positioned, large clamps should be used to hold frame in position.



Clamp the Frame

Fasten Frame to Cooler Wall

Use screws provided to fasten the bottom frame to the wall.

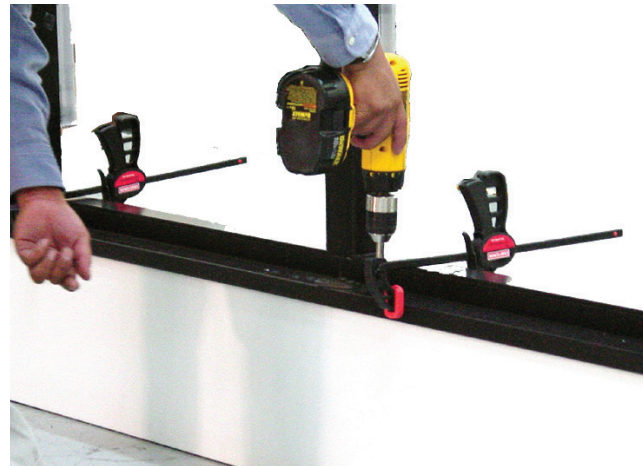
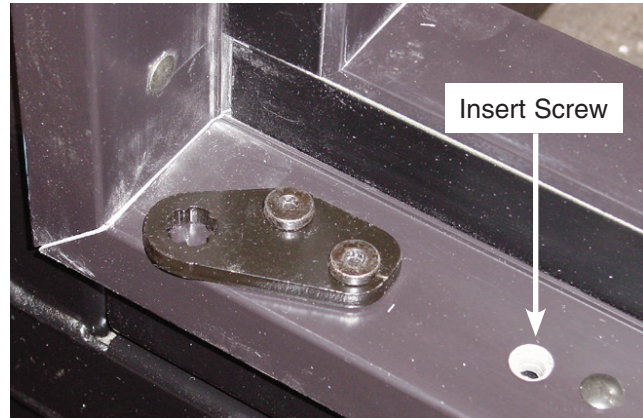

Fasten the Frame Bottom

Verify frame is still square.

Fasten side frame to wall with screws provided. Use shims as necessary. Do not distort frame by excessive tightening.



Keep Frame Level

Fasten top of frame to wall with screws provided. Do not distort frame by excessive tightening.

Use shims at each screw location to prevent distortion. Once screws are in, verify top of frame is straight and level from side to side.



Fasten Frame Top Last

IMPORTANT!
DO NOT OVER-TIGHTEN

JOINING FRAMES

Frame sides to be joined will have no front face flange.

Install the first frame as above, and prepare the second frame. Apply 1 in. wide gasket between wipes of each frame side to be joined. Lift the second frame into position and fasten the bottom as above.

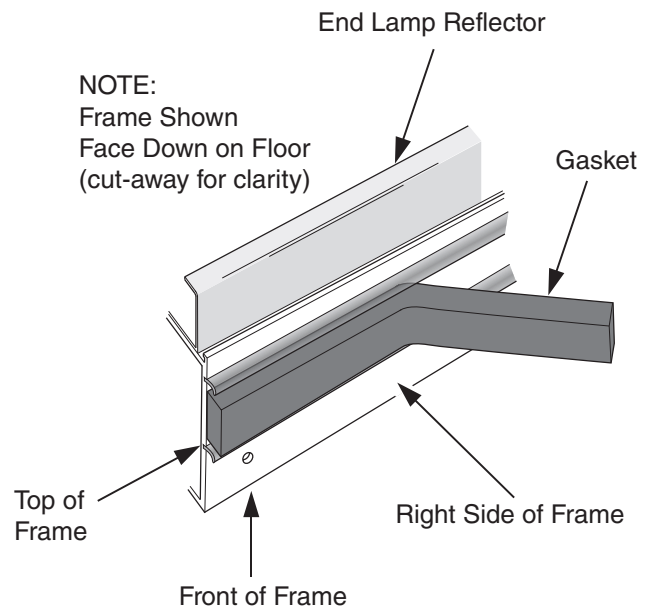

Install Gasket Between Wipes

Verify the second frame is still square.

If last frame in opening, fasten side frame to cooler wall opening.

Insert 'J' molding between frames. Fasten frames together with binding post and screw in five locations. Fasten top of frame to cooler wall opening. Do not distort frame sides or top.

Once all frames are installed, verify overall frame is square and plumb.

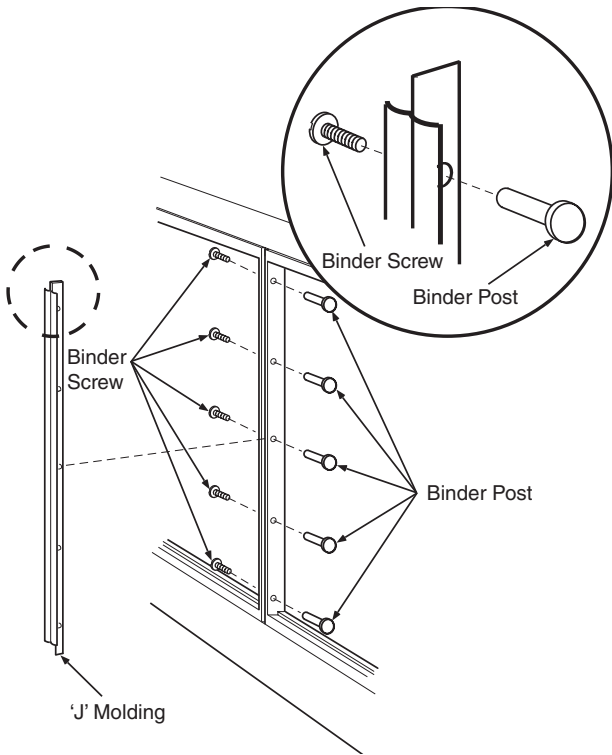

Install 'J' Molding Between Frames

SEAL INSIDE FRAME PERIMETER

Apply a small continuous bead of silicone sealant around the inside of the frame to seal the frame to the wall.



Apply Silicone Around Frame

ATTACH DOOR HANDLES

Carefully lift the magnetic gasket away from the frame nearest the handle location to expose the mounting screw holes as shown in below.

Install handle and screws carefully (*if gasket is damaged, it must be replaced*). After installing screws, gasket should again lie flat. If needed, use a mild soap and water solution to lubricate the gasket. Clean and dry the gasket to complete the door handle installation.

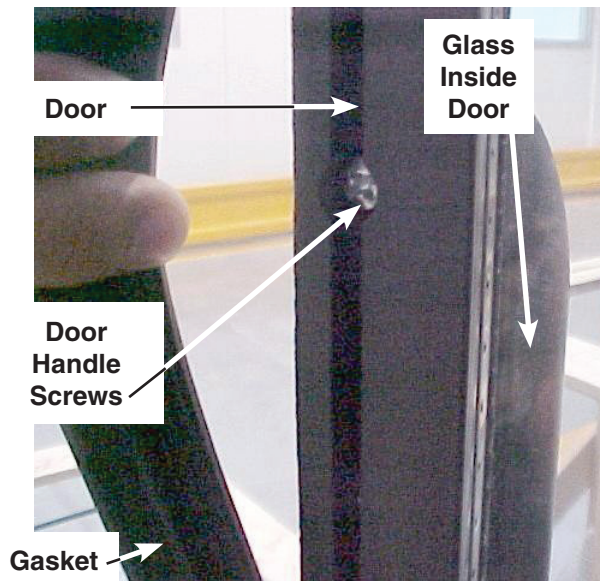

Lift Gasket at Handle Location

INSTALL DOORS

Insert the spring, bushing and pin in the top of door. Lift the door and insert the bottom hinge pin into the bottom hinge socket. Rotate the top of the door under the top socket while holding down the top hinge pin. Once the hinge pin is under the top socket, maneuver the door until the hinge pin pops into the socket.



Spring, Pin and Bushing

Ensure the hinge pin is fully engaged into the hinge plate as shown below.

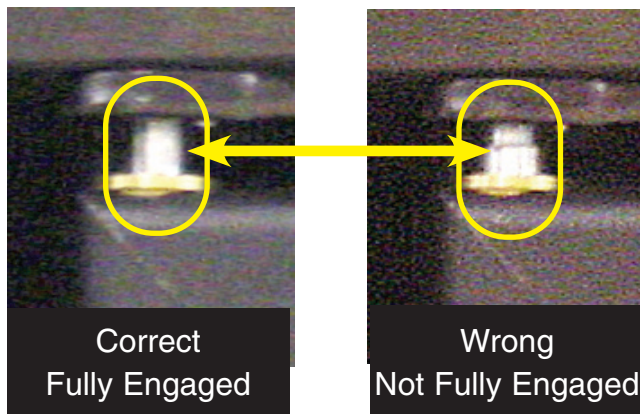

Ensure Hinge Pin is Fully Engaged into Hinge Plate

Use a flat blade screwdriver to lift the door retainer over the shoulder screw.

Open and close the door to verify hinge pins are fully seated and door is held in place.

Install remaining doors before adjusting doors.



Lift Door Retainer Over Shoulder Screw

ADJUST CLOSING TORQUE

Adjust closing torque by turning the bottom hinge pin in the direction the door closes. Use a 1/2 in. (13 mm) wrench. Turn the hinge pin until the door closes on its own, usually 3 to 4 clicks or 3/4 turn.

DO NOT over-torque the hinge spring assembly. Excessive torque (over 1 full turn) will result in damage to the spring assembly and/or door. If door does not close on its own after one full turn (5 clicks), look for obstructions causing the door to hang up.



Adjust Closing Torque

ADJUST DOOR SAG

To adjust door sag (saw-tooth effect from door to door), loosen the two hinge plate mounting screws using a Torx Plus no. 27 bit. Adjust hinge plate as needed, then tighten the screws.

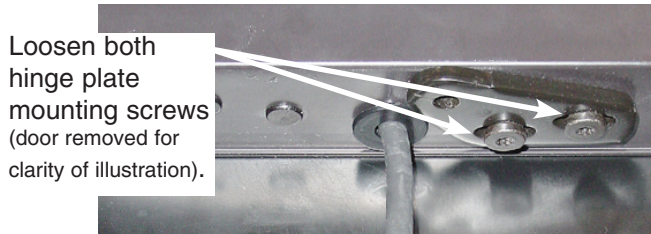

Adjust Door Sag

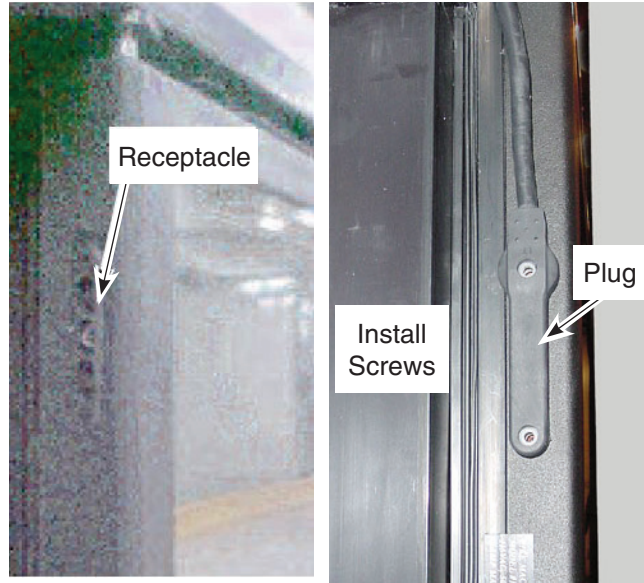

Connect Heater

⚠ WARNING

Always disconnect the electrical power at the main disconnect when servicing or replacing any electrical component. This includes, but is not limited to, such items as doors, lights, fans, heaters, and thermostats.

CONNECT WIRING FROM WIREWAY

Door system wiring is routed from the wireway through flexible conduit to be connected to the power source. Wiring diagrams for the heater harnesses follow. Wiring diagrams for the power supply and EcoShine LED lamps begin on page 19. Wiring diagrams for ballast and fluorescent lighting begin on page 26.

CONNECT HEATERS

NOTE: NOT ALL DOORS HAVE HEATER HARNESSSES.

Use screws supplied with the harness to attach the heater harness to the receptacle mounted in the door. **DO NOT use other screws** which may damage the door.

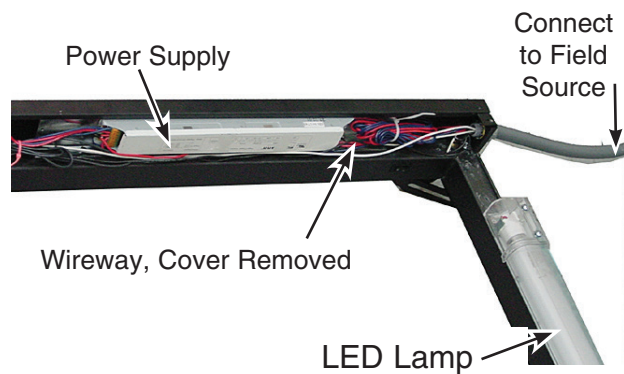

Connect Wireway Wiring to Power Source

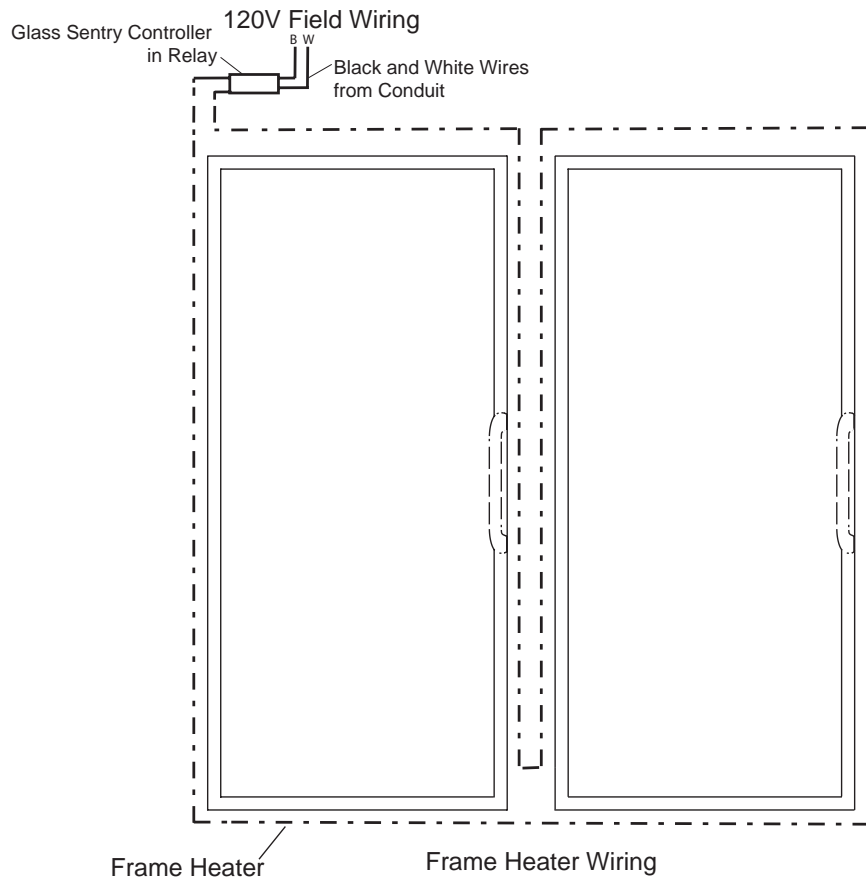

Field Wiring Connection

Each frame is connected to field wiring through junction boxes as shown below. Frames must not be wired in series. All wiring must be done in accordance with NEC and local codes.

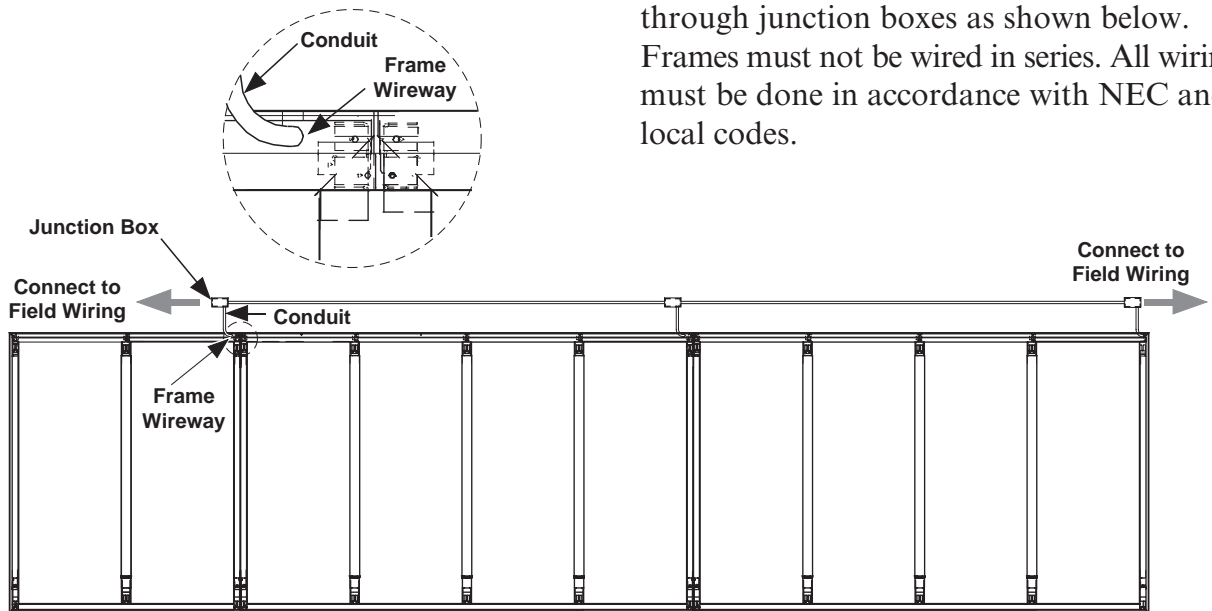

Connect Frame to Field Wiring

CONDITIONING GASKETS

In the factory environment, gaskets can be fitted to seal properly. However, the manufacturer cannot control the environment surrounding components during shipment or installation. Temperature and humidity fluctuations promote gaps which prevent sealing between gasket and frame. This is not a warranty issue or defect.

Before refrigerating the walk-in space, follow this procedure which was developed to ensure gaps close and gaskets seal properly in most environments.

1. Install the frames and doors, connect all wiring, and make adjustments as directed in the preceding pages.
2. Close each door. Use a flashlight to identify any gaps between frame and gasket.
3. Energize all anti-sweat, fan and light circuits for at least two hours, but not more than four hours, prior to initiating the refrigeration cycle.
4. Monitor all gaps.
5. Initiate cooling sequence after four hours or once the gaps disappear, whichever comes first.

Do not exceed 8 hours of energized circuits without refrigeration. Doing so may cause damage to doors and frames and will void the warranty.

If gaps remain at the end of four hours, follow the procedure for *Restoring Gasket Seal*, beginning on page 13 of this manual.

ATTENTION

TO ENSURE PROPER DOOR GASKET SEAL - INSTALL DOORS AND FRAMES, THEN ENERGIZE ALL ANTI-SWEAT AND LIGHT CIRCUITS 2 TO 4 HOURS PRIOR TO INITIATING REFRIGERATION CYCLE.

DO NOT EXCEED 8 HOURS OF ENERGIZED CIRCUITS WITHOUT REFRIGERATION. DAMAGE OR PRODUCT FAILURE MAY OCCUR AND VOID THE WARRANTY.
DO NOT REMOVE THIS LABEL UNTIL REFRIGERATION IS INITIATED.

⚠ WARNING

Always disconnect the electrical power at the main disconnect when servicing or replacing any electrical component. This includes, but is not limited to, such items as doors, lights, fans, heaters, and thermostats.

SERVICE AND MAINTENANCE

Replacing Doors

1. Loosen torque on door before removing the door. Wedge a screwdriver between the bottom of the door and the hinge socket, then lift the door up. This will lift the bottom hinge pin up and out of the bottom hinge socket. **Hold the hinge pin** with a 1/2 in. (13 mm) open end wrench to keep it from spinning out and stripping the socket.

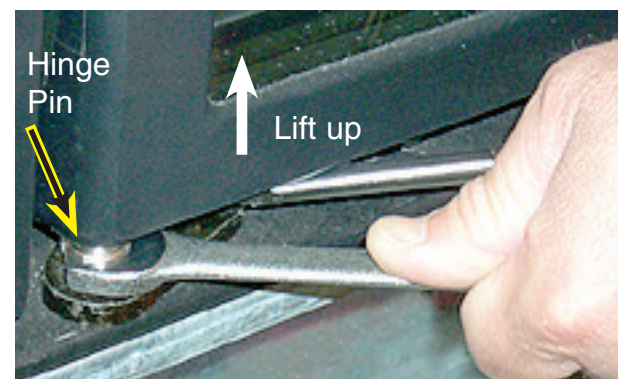
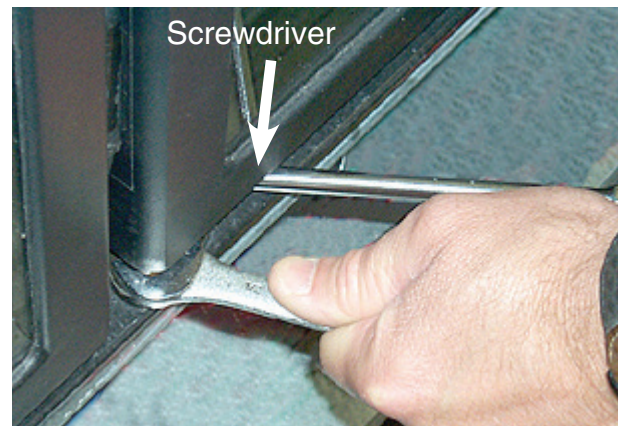

Loosen Torque on the Door

2. Use a flat blade screwdriver as shown to lift the door retainer over the shoulder screw.



Lift Door Retainer

3. Push down the spring-loaded top hinge pin until it clears the top socket using a flat blade screwdriver. With finger, ***hold the hinge pin in the door to keep it from popping out.*** Tape may be used to temporarily hold the hinge pin once door is removed.

4. Rock the door out and pull the bottom hinge pin out from the bottom socket.

5. Install the new door in reverse order.

6. Adjust the torque on the new door. If needed, adjust sag.

Replacing Door Hinge Spring

The door must be removed before replacing the door hinge spring.

Pull the hinge spring assembly out of the bottom of the door and replace with a new assembly. Note that there are right-hand and left-hand hinge spring assemblies.

Replacing Magnetic Gasket

Carefully remove the old gasket from the groove in the back of the door. The new gasket will be easier to work with if it is at ambient temperature. Begin by lubricating the new gasket with a mild soap and water solution.

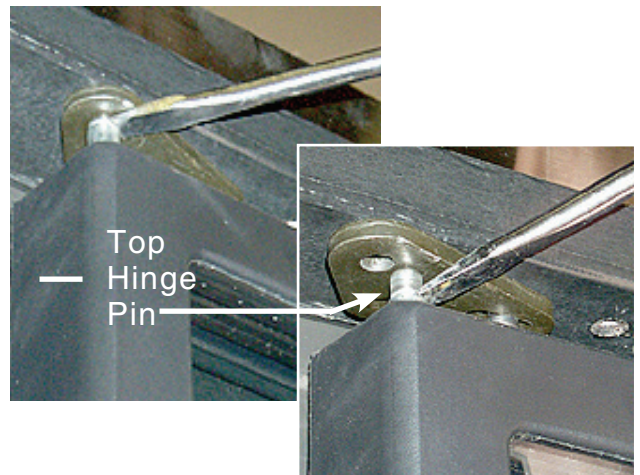

Remove Top Hinge Pin from Top Hinge Socket



Replace Door Hinge Spring

Work from the corners to the centers of each side, top and bottom. Carefully push the new gasket into the groove at each corner, refer to sequence (A). Then, push the gasket into the channel at the center of the top, bottom and each side, (B). Avoid stretching the gasket.

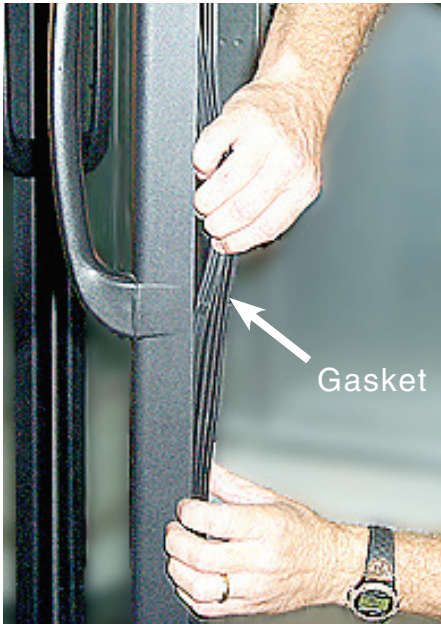

Remove Door Gasket

Sub-divide remaining areas and push the gasket in at those points, (C).

Sub-divide once again and repeat pushing the gasket in until all of the gasket is evenly seated in the groove, (D).

Use a soft cloth or paper towels to dry the gasket before closing door on clean door frame.

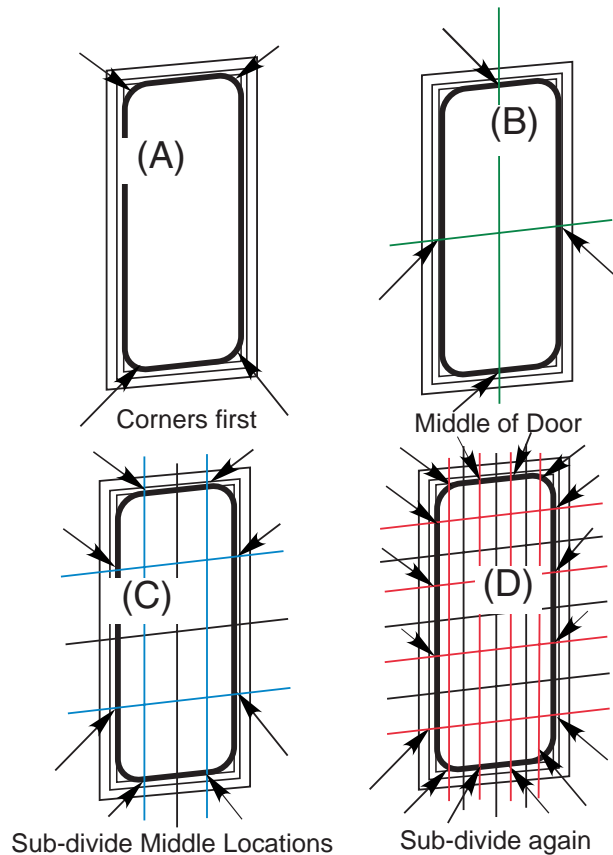

Sequence for Installing New Gasket

Restoring Gasket Seal

Occasionally, a crimped or damaged gasket can cause gaps in the seal, leading to frost formation on the doors. Use this procedure to close gaps and end frost formation on doors.



Improperly Installed or Damaged Gasket

LOCATE GAPS

Normally, interior ambient lighting will provide enough light to see gaps. In some cases, the only way to see gaps is to provide a backlight as shown (A). Backlight the door mullion and look for places the light shines between the door and gasket, (B).

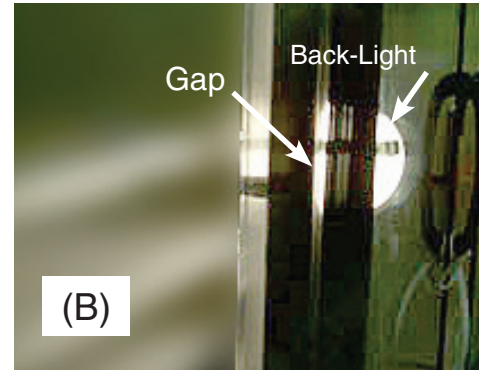
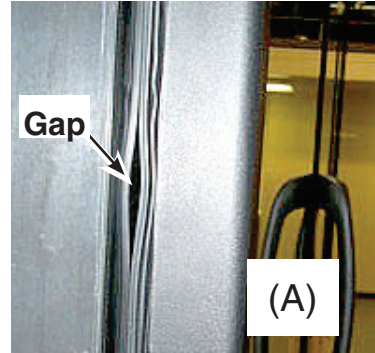

Back-Lighting Gaps in Gasket

HEAT THE GASKET

Make sure the door is closed. Beginning at the top of the gap, use a heat gun or electric hair dryer (1500-1600 watt) to heat the gasket with a constant up and down motion.

IMPORTANT: If a gap runs the entire length of the door, heat the area 4 in. (100 mm) above and 8 in. (200 mm) below the top-most point where the gap starts and work in 12 in. (300 mm) increments.

If the gasket becomes shiny, remove heat immediately as this is an indication that the gasket is near the melting point.

If possible, direct the hot air onto the gasket and also through the gap between the gasket and mullion. This will help to heat both sides of the gasket.

As the gasket softens and becomes pliable, the magnet in the gasket should pull it across the gap. As the gap closes, move heat down to create a zippering effect as shown.

If the gasket is not pulled across the gap by the magnet, reach around the mullion (from the inside) and pull the gasket skirt toward the mullion.

This can also be accomplished by pushing the magnet across the gap from the outside with a pencil or other non-heat conducting material.

On doors where the gap is against an end, top, or bottom mullion, this process can still be done; however, the heat will need to be directed between the lip of the mullion and the edge of the door. It will work in the same fashion but the back-light shining through and showing on the mullion will have to be a guide as to the position of the gasket.

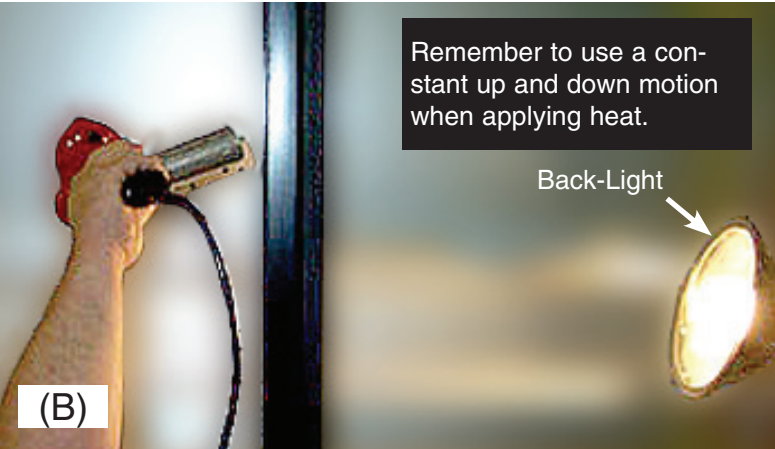
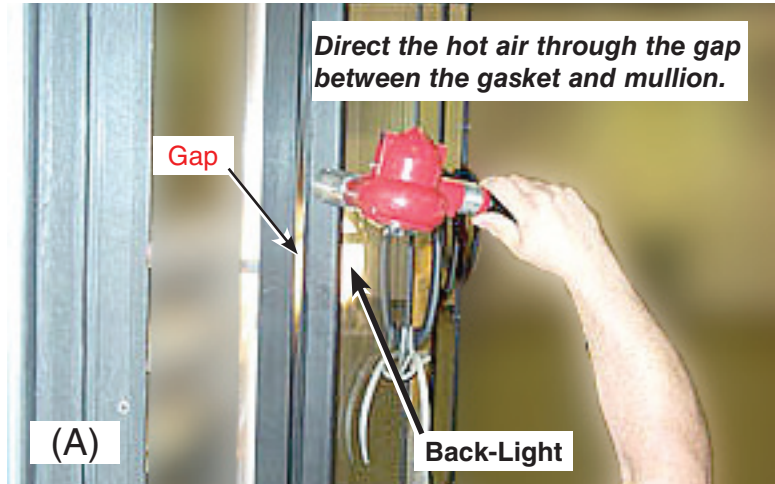

Applying Heat to Gasket

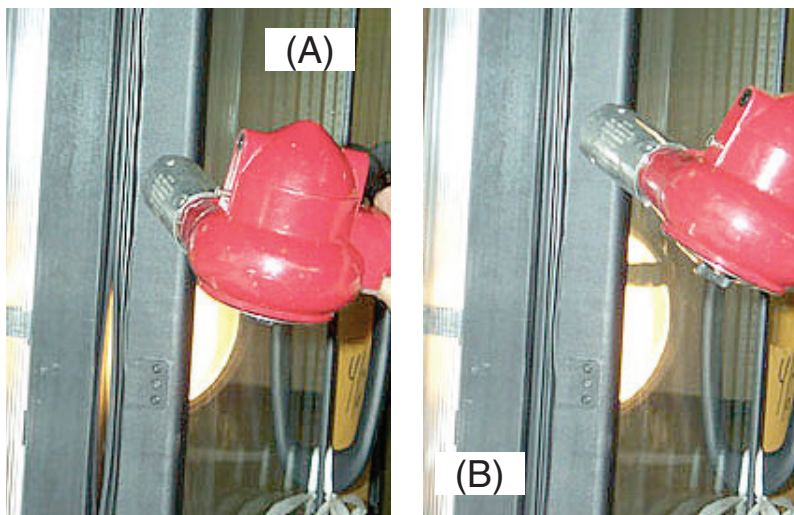

Zipper Effect



Pulling Gasket Into Place With a Pencil

Cool the Gasket

Once the gap is closed, remove the heat and allow the gasket to cool, undisturbed, for 3 to 5 minutes. As the gasket cools, it will set permanently in this new shape.

Once the gasket is cool to the touch, open and close the door. Verify that the gasket seals. If not, repeat the process. If the gasket rolls it must be replaced.

Use a soft cloth or paper towels, and a mild soap and water solution to thoroughly clean the gasket. Dry the gasket completely with a fresh cloth or paper towels before closing the door on a clean door frame.

Door Handle Replacement



Carefully pull the magnetic gasket away from the glass nearest the handle to expose the mounting screws as shown. Remove the screws and replace the handle. After reinstalling screws, carefully push gasket back into place. If needed, use a mild soap and water solution to lubricate the gasket. Clean and dry the gasket to complete the door handle replacement.

Mounting Screws



Replacing Door Handle

LED Fixture

The new LED (light emitting diode) lights work well for dimming or on/off operation using an occupancy sensor (optional kits). They can be turned on and off in a cold environment with no warm-up time and no negative impact on lamp life.

LED Fixture Replacement

1. Remove product from the cooler and store appropriately.
2. Remove the wire racks from the cooler. Store them out of the way of customers and store personnel.
3. Turn the light switch to *OFF*. The switch is located inside the cooler on the door mullion.
4. Lock out and tag out the circuit breaker for the lighting circuit of the cooler where the LED fixtures are installed.
5. Disconnect fixture wiring. Tag cooler wiring with color of fixture wire color connected. LED lighting is polarity sensitive.
6. Remove Fixtures.

Refer to manufacturer’s documentation for LED fixtures other than Hussmann’s EcoShine™ brand.

⚠ WARNING
 – LOCK OUT / TAG OUT –
To avoid serious injury or death from electrical shock, always disconnect the electrical power at the main disconnect when servicing or replacing any electrical component. This includes, but is not limited to, such items as doors, lights, fans, heaters, and thermostats.

LED light fixtures are polarity sensitive. The power supply positive wire must be electrically connected to the red wires of the LED fixture. The power supply negative wire must be connected electrically to the black wires. See Wiring Diagrams.

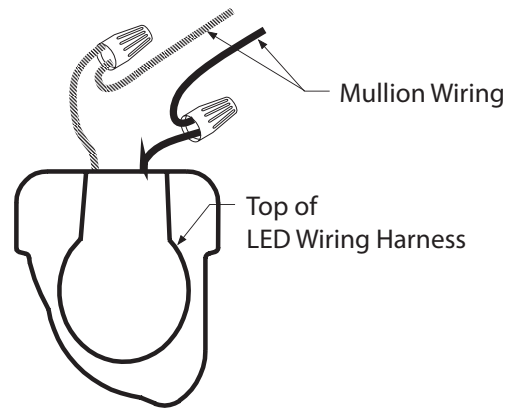

Disconnect Wiring
 (Center Fixture Shown, End Fixture Similar)

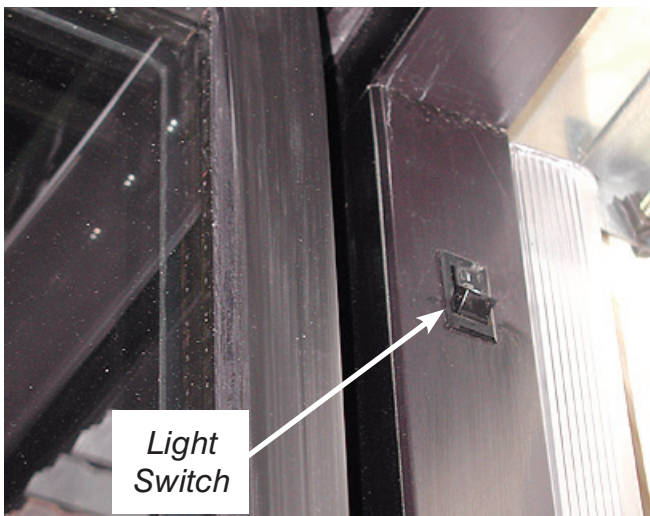

7. Reassemble in the reverse order of disassembly.

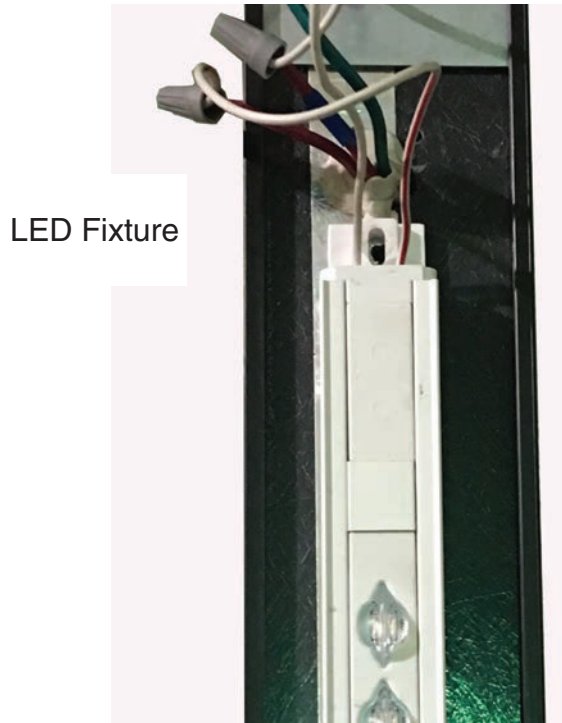

Figure 4.

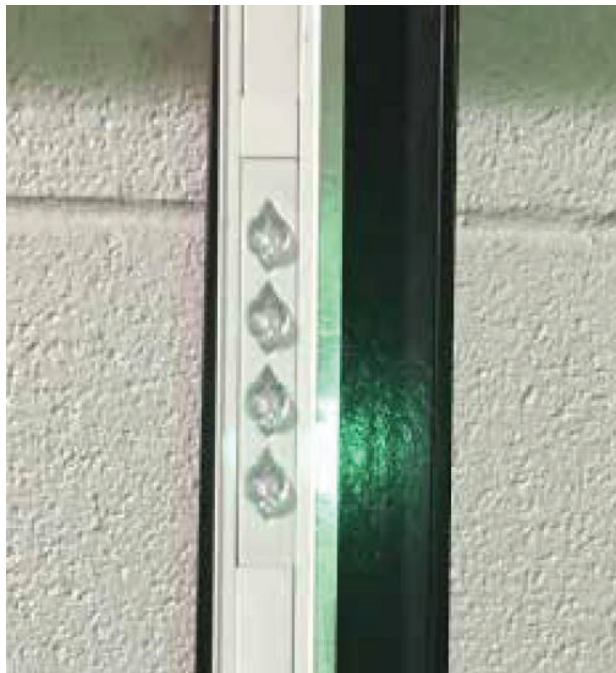

Figure 5. Interior View of End Fixture

Remove Protective Film

Often, an LED fixture is shipped with a protective film over the lens, as shown in Figure 6. Remove and recycle the film.

LED Power Supply Replacement

Power supplies are located in the raceway above the door frame.

To access the raceway, remove the bumper, then remove the #8 hex head screws that hold on the front painted panel.



Frame Heater Replacement

Always turn off power to the unit before working on any electrical components. The old wireway covers must be removed to access the door frame heaters. Begin by inserting a putty knife into the groove between the wireway cover and fiberglass frame, about an inch (25 mm) away from joints in the frame as shown in (A). Carefully begin to pry off the cover.



As shown in (B), use a second putty knife or flat head screwdriver to hold up the cover. Pry the remainder of the section up, using putty knife only, until the entire cover is off and the frame heater inside the door frame is exposed.



Remove Wireway Cover

Door frame heaters may now be replaced. During installation, the white portion of the heater should not come in contact with itself. The heater should be installed so that only one white portion of the wire enters the wireway. The other portion entering the wireway will be the black lead wire.

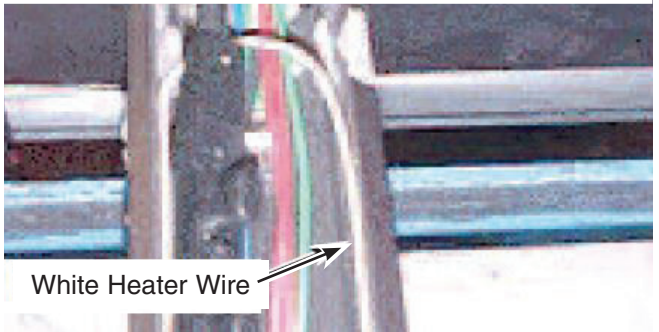
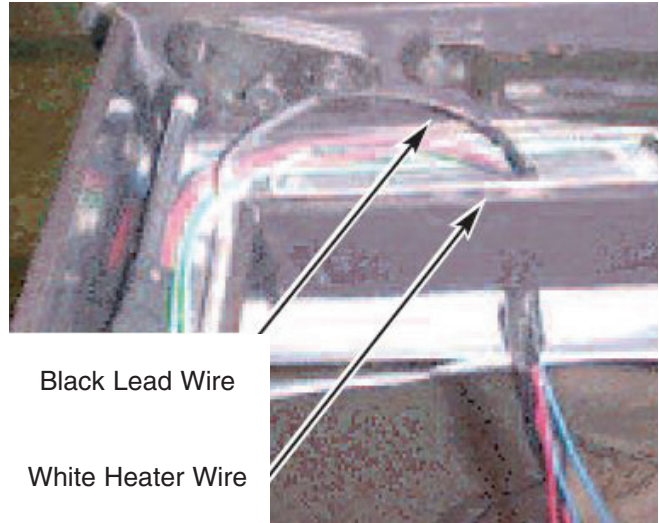

Remove and Replace Frame Heater

Once the heater wire is connected, check resistance (ohm reading) before replacing wireway covers. This will ensure that heater wire was not broken during installation. After covers are reinstalled, turn power on and verify that heaters are working properly.

Dimmer Control

The LED Dimmer Control regulates the brightness of the merchandiser's LED lighting. A passive infrared motion detector located on the top front center of merchandisers or on the wall for wall mounts, detects the presence of approaching customers.

NOTE: THE MOTION DETECTOR IS AVAILABLE IN GRAY, BLACK AND PEARL.

A signal is passed to the dimmer control, which is connected to the LED lighting power supply.

The dimmer control receives a signal from the motion detector and adjusts the brightness of the merchandiser's LED lights accordingly.

The amount of LED brightness emitting from the merchandiser lights can be modulated from 100% to 0%, 20% or 50% as selected by the installer. The Motion Activated Dimmer Control regulates the application of power to the LED lighting and is powered by a LED 24VDC power supply.

Dimmer Control is factory set to 20% minimum LED brightness.

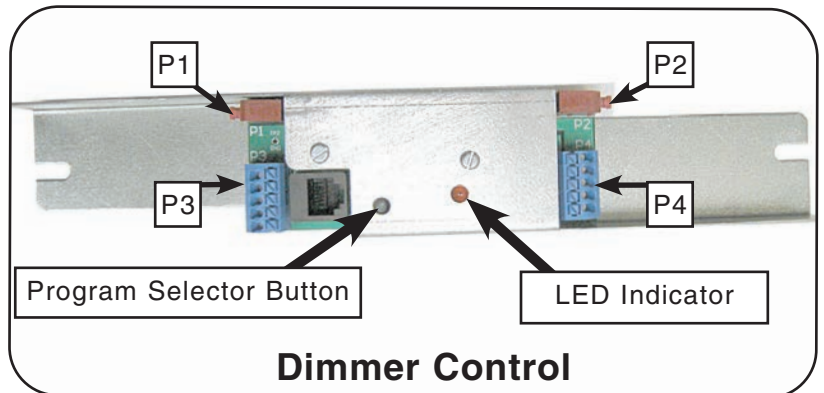
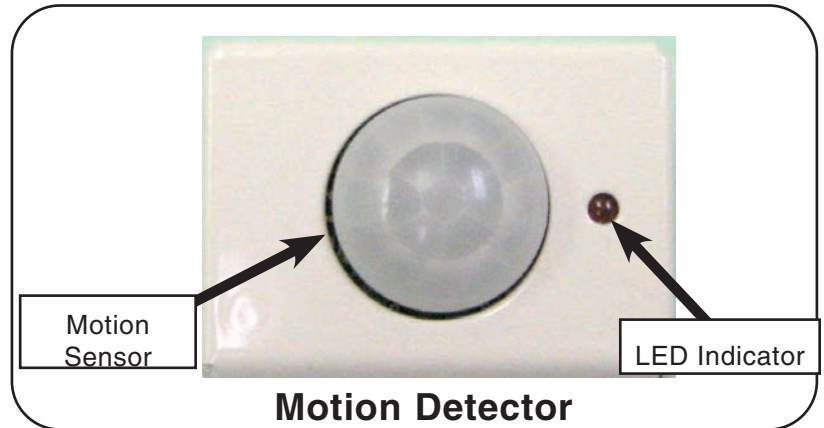



CAUTION

To avoid overheating and possible damage to other equipment, **DO NOT** use dimmers to control receptacles, or fluorescent lighting fixtures.

Operation

When power is first applied to the Motion Activated LED Dimmer Control, The LED Indicator flashes two times and the LED lights are set to dim at 20%. The dimmer control can be set to dim the LED lights to 0%, 20% and 50% respectively.

The dimmer level remains at 20% for five seconds, and is then elevated to 100%. After one minute, the motion detector “learns” the background environment. During this time, the output will remain at 100%. If no motion is detected after 30 seconds, the LED brightness will dim to the selected output minimum from the dimmer control.

This dimming takes place over a period of three seconds as the lighting is reduced from 100% to the selected minimum as programmed on the dimmer control. The minimum setting can be set to 0% (off), 20% (default setting), or 50%.

When motion is detected again, the LED brightness will increase to 100% over one second. Lighting will again remain at 100% until 30 seconds of no detected motion.

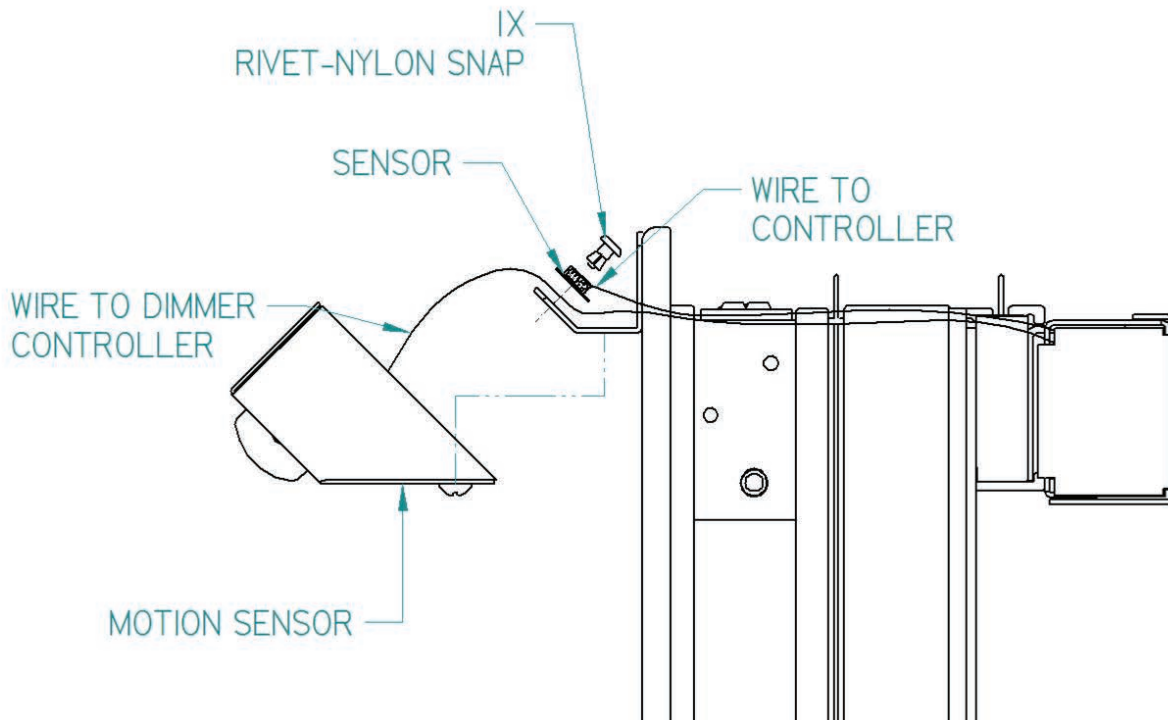

Program Dimmer Control

The Motion Activated LED Dimmer Control is factory installed and set to 20% minimum LED brightness. The dimmer control is located near the merchandiser’s LED lighting power supplies. This may require the installer to remove the case bumper and front panel to access the wireway or to open the canopy lamp panel. Locate the dimmer control. Press and hold the program selector button on the dimmer control for three seconds. This enters the Motion Activated LED Dimmer Control’s program mode. The LED on the dimmer control will flash four times.

From program mode, press the program selector button one time, and the LED on the dimmer control will flash one time. Case LEDs will turn off. The case LED lights are now set to dim to 0% minimum.

From program mode, press the program selector button twice, and the LED on the dimmer control will flash two times, Case LEDs will illuminate to 20%. The case LED lights are now set to 20% minimum.

From program mode, press the program selector button three times, and the LED on the dimmer control will flash three times. Case LEDs will illuminate to 50%. The LED lights are now set to 50% minimum. Program mode times out after 30 seconds. (This is the only way to exit program mode.) After 30 seconds, the case LEDs will illuminate to 100% to indicate exit from program mode.

NOTE: Dimmer Control is factory set to 20% minimum LED brightness.

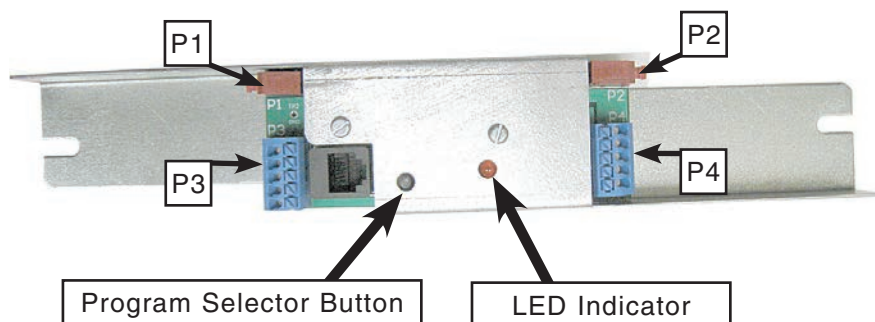

Dimmer Control

Motion Detector Switch

A switch on the top rear of the motion detector has two settings ON and DIM.

When the switch is set to ON, the merchandiser LEDs will power to 100%, bypassing the motion sensor.

The motion sensor will operate normally when the switch is set to DIM.

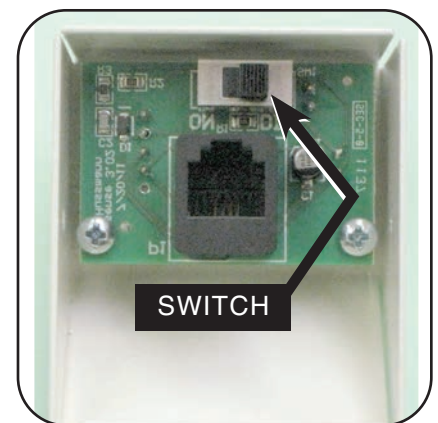

Dimmer Switch in “DIM” position.

NOTE:
Do not paint motion detector. Painting motion detector may cause overheating, or loss of motion sensing capability.

Do not mount motion detector in outdoor areas.

TROUBLESHOOTING GUIDE

Problem	What to Check for	Possible Causes	Solution / Action
Case LEDs stay at 100% after one and a half minutes of operation.	LED Indicator on Motion Detector is "ON." Dimmer Control LED Indicator is lit.	Dimmer Control has a startup delay of about one and a half minutes, and the Motion Sensor had not warmed up.	Wait more than two minutes for Motion Sensor to dim to programmed setting on Dimmer Control.
Case LEDs stay at 100%.	LED Indicator on Motion Detector is "ON." Dimmer Control LED Indicator is lit.	Sensor sensing motion.	Ensure all objects remain motionless in the view of Motion Detector for more than 30 seconds.
Case LEDs stay at 100%.	LED Indicator on Motion Detector is "ON." Dimmer Control LED Indicator is lit.	Switch on Motion Detector is in the "ON" position, bypassing the Dimmer Control.	Move Motion Detector switch to "DIM" position.
Case LEDs stay at 100%.	LED Indicator on Motion Detector is "ON." Dimmer Control LED Indicator is lit.	Dimmer Control is wired backwards.	Wire Power Supply to the Dimmer Control input and the LEDs to the Dimmer Control output.
Case LEDs stay at 100%.	LED Indicator on Motion Detector is "OFF." Dimmer Control LED Indicator is lit.	RJ-11 connector is not properly seated or bad RJ-11 Connector Cord.	Install new RJ-11 Connector Cord.
Case LEDs stay at 100%.	No motion is present. Dimmer Control LED Indicator flashes at 1-second interval.	Bad Dimmer Control.	Install new Dimmer Control.
Case LEDs stay at dimmed level.	Motion Detector detects no motion. LED Indicator on Motion Detector is "OFF." Dimmer Control LED Indicator flashes at 1-second interval.	Bad Motion Detector.	Install new Motion Detector.

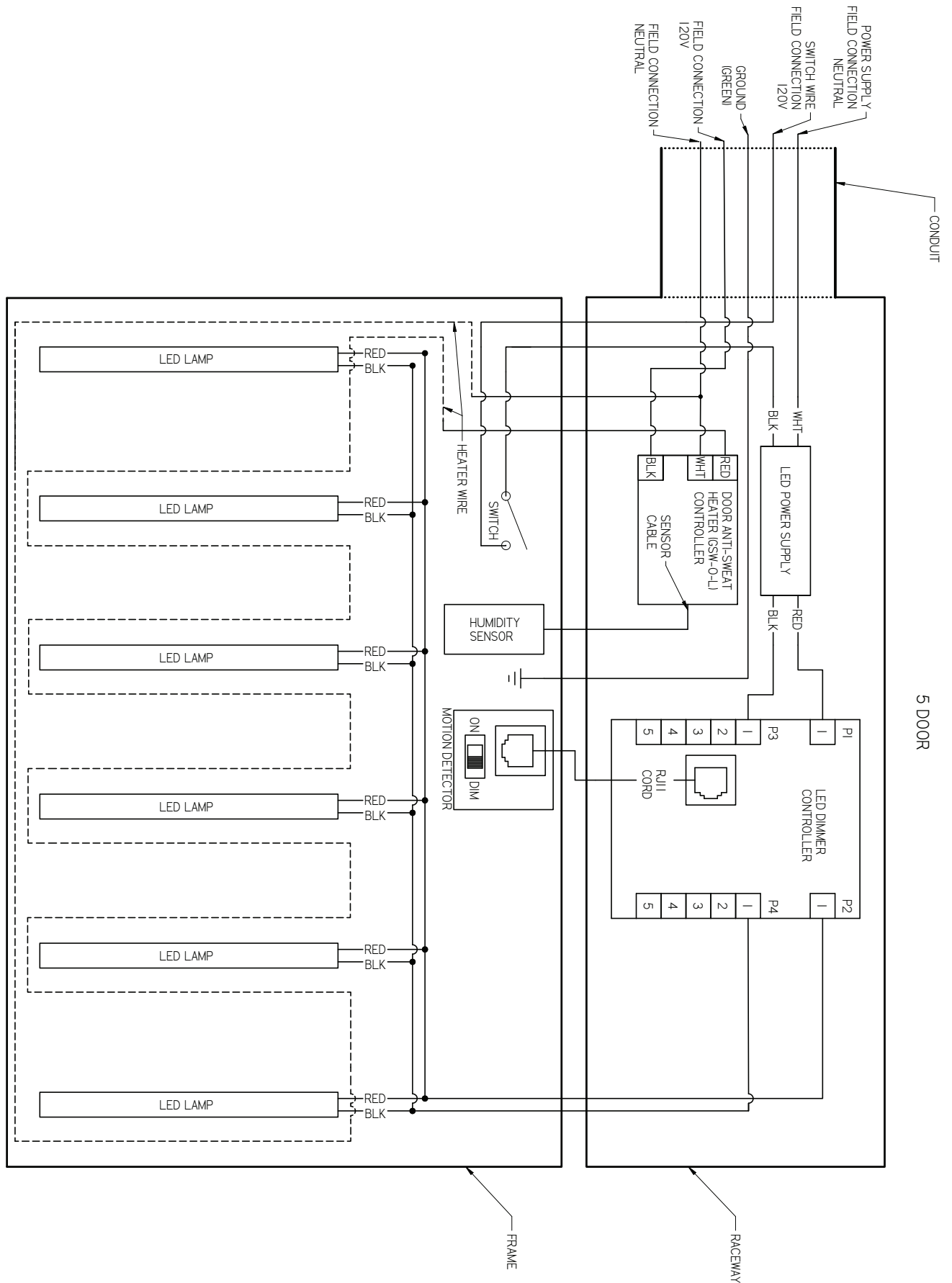

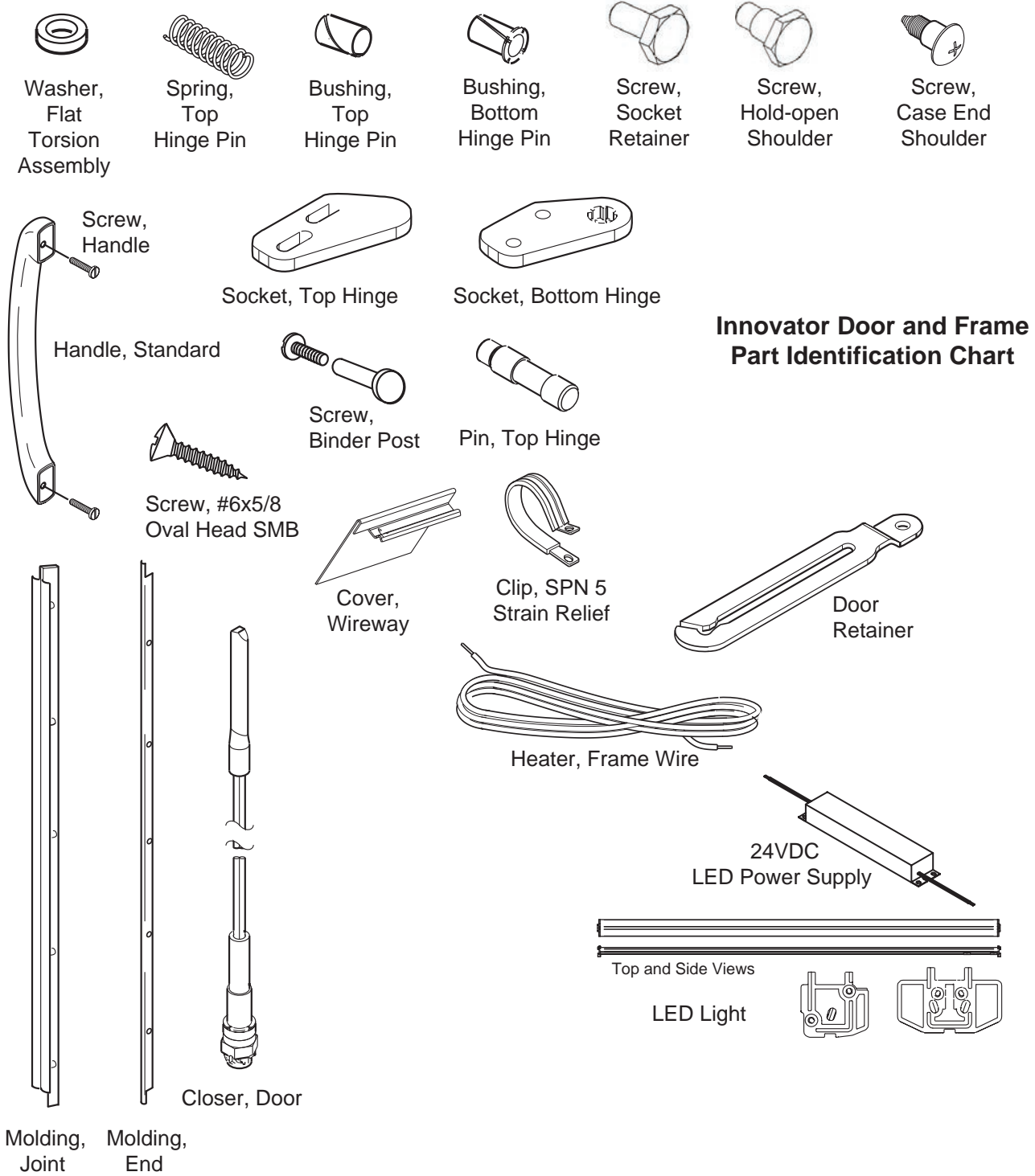



HUSSMANN[®]

**To obtain warranty information
or other support, contact your
Husmann representative.
Please include the model and
serial number of the product.**

Husmann Corporation, Corporate Headquarters: Bridgeton, Missouri, U.S.A. 63044-2483 01 October 2012

Husmann Corporation

12999 St. Charles Rock Road
Bridgeton, MO 63044-2483
www.husmann.com